

CUADERNILLO DE **sumas**

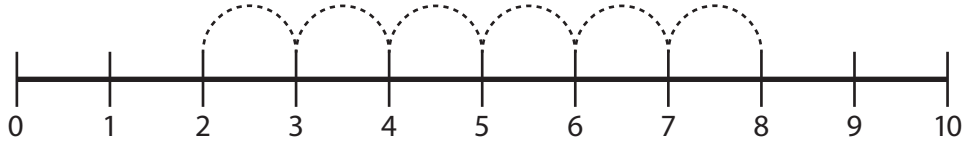

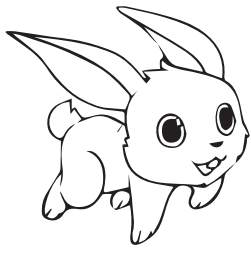

$$\boxed{2} + \boxed{6} = \boxed{}$$

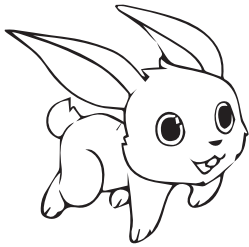

$$\boxed{2} + \boxed{2} = \boxed{}$$

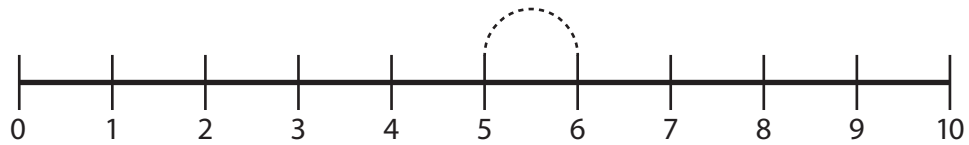
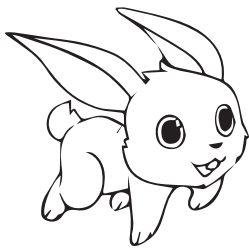

$$\boxed{5} + \boxed{1} = \boxed{}$$

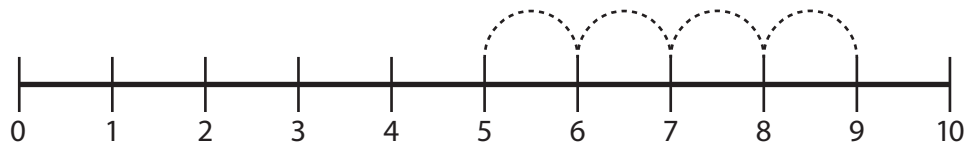
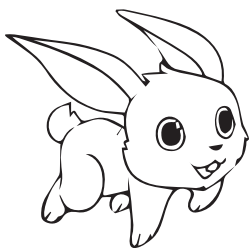

$$\boxed{5} + \boxed{4} = \boxed{}$$

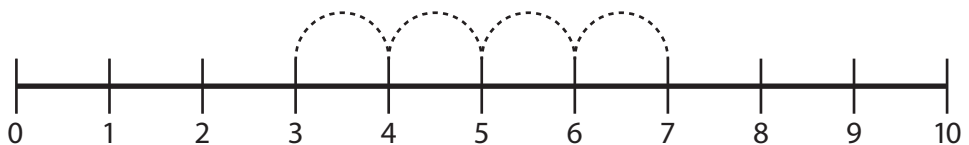
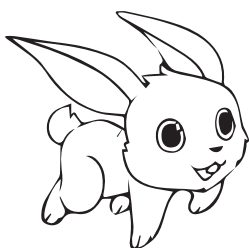

$$\boxed{3} + \boxed{4} = \boxed{}$$

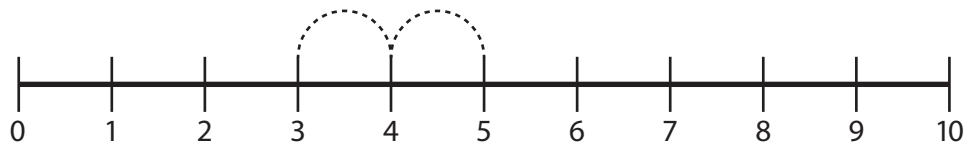
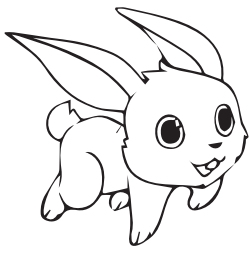

$$\boxed{3} + \boxed{2} = \boxed{}$$

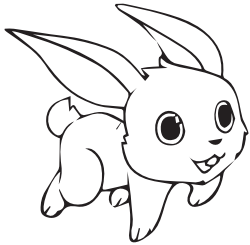

$$\boxed{1} + \boxed{1} = \boxed{}$$

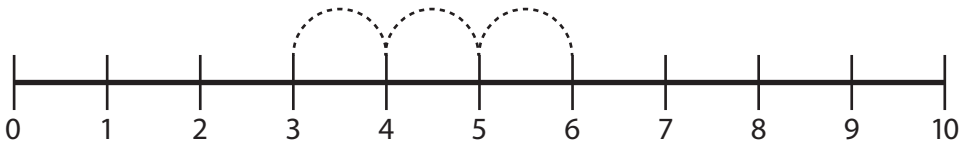
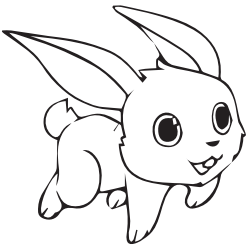

$$\boxed{3} + \boxed{3} = \boxed{}$$

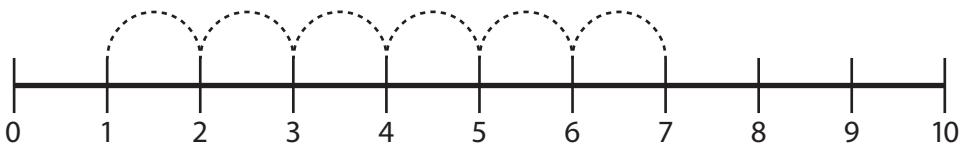
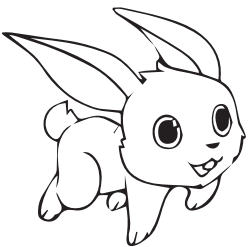

$$\boxed{1} + \boxed{6} = \boxed{}$$

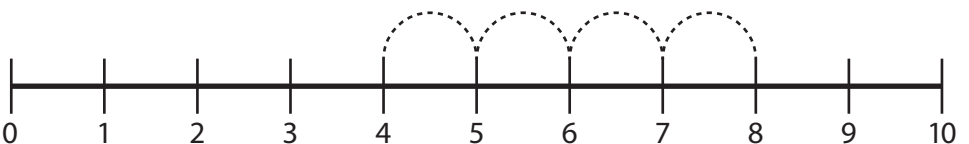
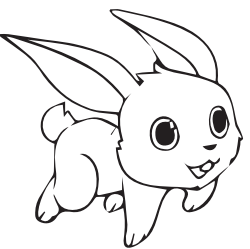

$$\boxed{4} + \boxed{4} = \boxed{}$$

$$\square + \begin{array}{|c|} \hline \bullet \\ \hline \bullet \\ \hline \end{array} = \square$$

$$\begin{array}{|c|} \hline \bullet \bullet \\ \hline \bullet \bullet \\ \hline \end{array} + \begin{array}{|c|} \hline \bullet \\ \hline \bullet \\ \hline \end{array} = \square$$

$$\begin{array}{|c|} \hline \bullet \bullet \\ \hline \bullet \bullet \\ \hline \end{array} + \begin{array}{|c|} \hline \bullet \\ \hline \bullet \\ \hline \end{array} = \square$$

$$\begin{array}{|c|} \hline \bullet \\ \hline \end{array} + \begin{array}{|c|} \hline \bullet \bullet \\ \hline \bullet \bullet \\ \hline \end{array} = \square$$

$$\begin{array}{|c|} \hline \bullet \\ \hline \bullet \\ \hline \end{array} + \begin{array}{|c|} \hline \bullet \\ \hline \bullet \\ \hline \end{array} = \square$$

$$\begin{array}{|c|} \hline \bullet \bullet \\ \hline \bullet \bullet \\ \hline \end{array} + \begin{array}{|c|} \hline \bullet \bullet \\ \hline \bullet \bullet \\ \hline \end{array} = \square$$

$$\begin{array}{|c|} \hline \bullet \bullet \\ \hline \bullet \bullet \\ \hline \end{array} + \begin{array}{|c|} \hline \bullet \\ \hline \end{array} = \square$$

$$\begin{array}{|c|} \hline \bullet \\ \hline \end{array} + \begin{array}{|c|} \hline \bullet \\ \hline \bullet \\ \hline \end{array} = \square$$

$$\begin{array}{cc} \heartsuit & \heartsuit \\ \heartsuit & \heartsuit \\ \heartsuit & \heartsuit \\ \heartsuit & \heartsuit \end{array} + \begin{array}{c} \heartsuit \\ \heartsuit \\ \heartsuit \end{array} = \square$$

$$\begin{array}{cc} \heartsuit & \heartsuit \\ \heartsuit & \heartsuit \\ \heartsuit & \heartsuit \end{array} + \begin{array}{c} \heartsuit \\ \heartsuit \end{array} = \square$$

$$\begin{array}{c} \star \\ \star \\ \star \\ \star \\ \star \end{array} + \begin{array}{c} \star \\ \star \\ \star \\ \star \end{array} = \square$$

$$\begin{array}{c} \star \\ \star \\ \star \end{array} + \begin{array}{c} \star \\ \star \end{array} = \square$$

$$\begin{array}{cc} \heartsuit & \heartsuit \\ \heartsuit & \heartsuit \end{array} + \begin{array}{cc} \heartsuit & \heartsuit \\ \heartsuit & \heartsuit \end{array} = \square$$

$$\begin{array}{cc} \heartsuit & \\ \heartsuit & \heartsuit \\ \heartsuit & \heartsuit \end{array} + \begin{array}{c} \heartsuit \\ \heartsuit \\ \heartsuit \end{array} = \square$$

$$\begin{array}{c} \star \\ \star \\ \star \\ \star \\ \star \\ \star \\ \star \end{array} + \begin{array}{c} \star \\ \star \\ \star \\ \star \\ \star \end{array} = \square$$

$$\begin{array}{c} \star \\ \star \\ \star \\ \star \end{array} + \begin{array}{c} \star \\ \star \\ \star \end{array} = \square$$

$$\boxed{5} + \boxed{5} = \boxed{}$$

$$\boxed{1} + \boxed{1} = \boxed{}$$

$$\boxed{4} + \boxed{3} = \boxed{}$$

$$\boxed{1} + \boxed{3} = \boxed{}$$

$$\boxed{4} + \boxed{1} = \boxed{}$$

www.materialparamaestros.com

5

7

10

4

2

$7 + 1$

4 6 8 2

$3 + 3$

5 7 8 6

$1 + 6$

4 6 1 7

$5 + 4$

9 7 8 6

$2 + 1$

2 4 1 3

$5 + 3$

5 8 9 3

$1 + 1$

2 3 4 5

$2 + 3$

6 5 7 2

$5 + 5$

9 11 10 13

$7 + 4$

11 17 10 16

$8 + 6$

12 15 11 14

$9 + 7$

13 17 16 15

$6 + 1$

9 7 6 10

$9 + 8$

17 19 20 18

$3 + 9$

11 15 14 12

$4 + 11$

16 15 17 12

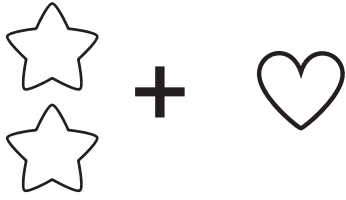

$2 + 1 = \square$

$6 + 2 = \square$

$4 + 1 = \square$

$3 + 3 = \square$

$8 + 2 = \square$

$5 + 7 = \square$

$8 + 8 = \square$

$2 + 9 = \square$

$$\boxed{1} + \boxed{2} = \boxed{}$$

$$\boxed{2} + \boxed{4} = \boxed{}$$

$$\boxed{4} + \boxed{1} = \boxed{}$$

$$\boxed{6} + \boxed{2} = \boxed{}$$

$$\boxed{5} + \boxed{4} = \boxed{}$$

www.materialparamaestros.com



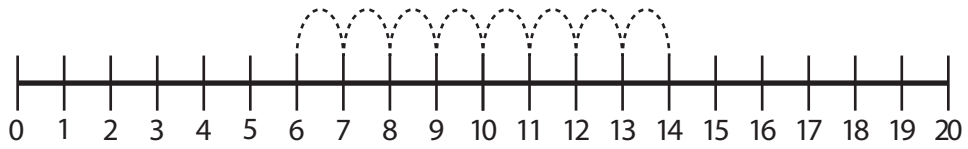
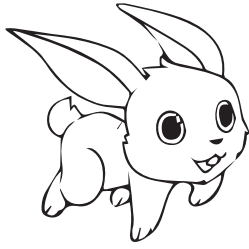

$$\boxed{6} + \boxed{8} = \boxed{}$$

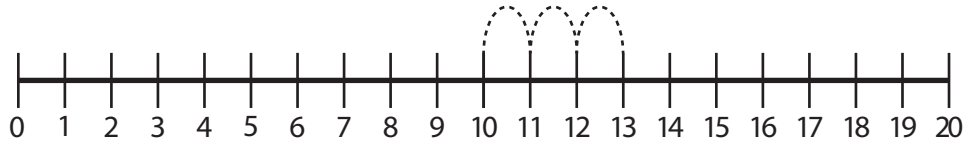
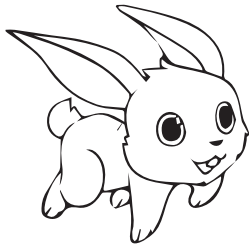

$$\boxed{10} + \boxed{3} = \boxed{}$$

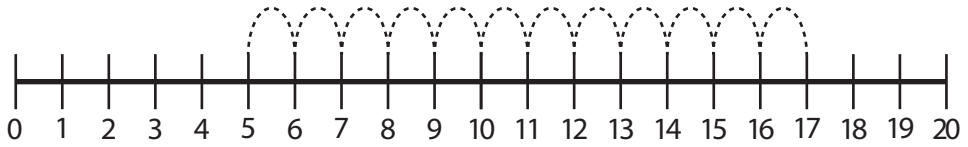
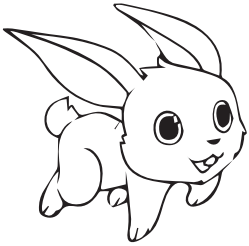

$$\boxed{5} + \boxed{12} = \boxed{}$$

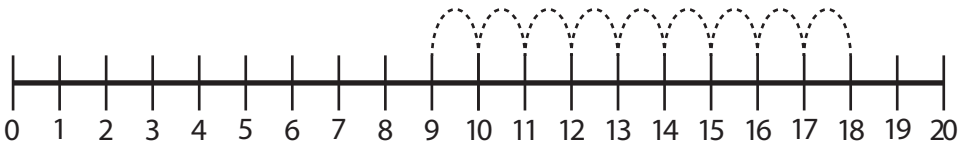
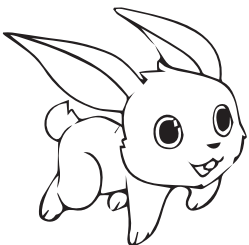

$$\boxed{9} + \boxed{9} = \boxed{}$$

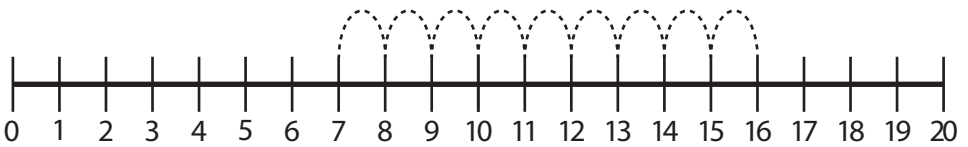
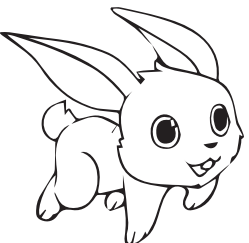

$$\boxed{7} + \boxed{9} = \boxed{}$$



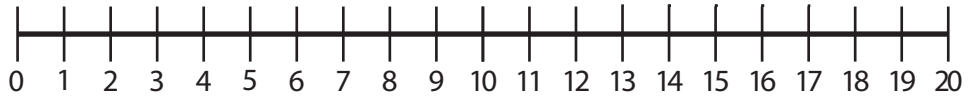
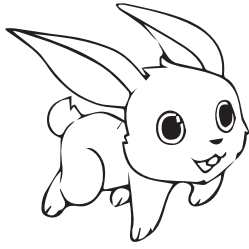

$$\boxed{13} + \boxed{4} = \boxed{}$$

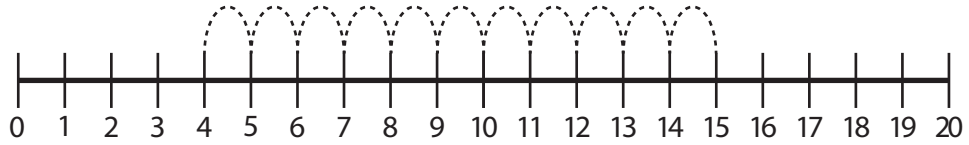
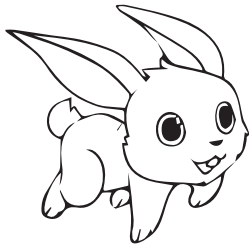

$$\boxed{4} + \boxed{11} = \boxed{}$$

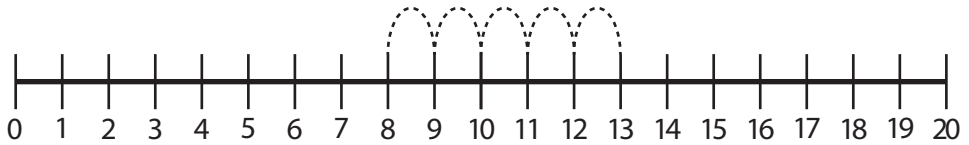
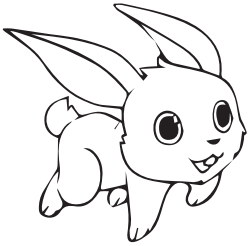

$$\boxed{8} + \boxed{5} = \boxed{}$$

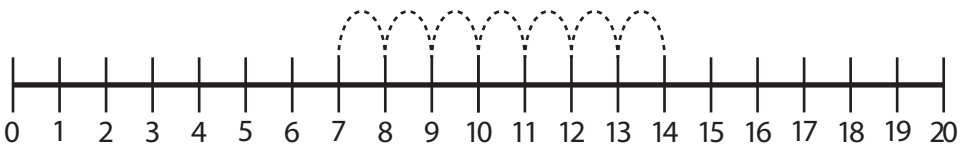
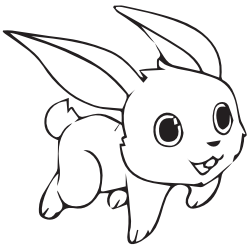

$$\boxed{7} + \boxed{7} = \boxed{}$$

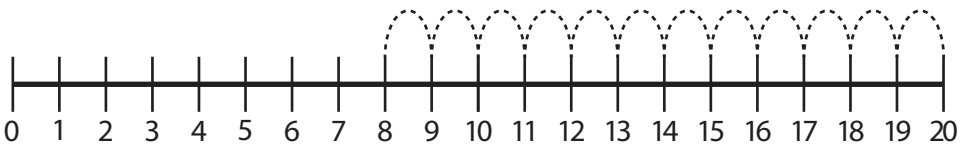
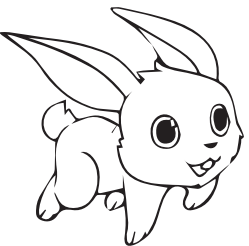

$$\boxed{8} + \boxed{11} = \boxed{}$$



¡SUMA Y RECORTA!

Escribe el resultado en la SUMA, después recorta los resultados y pégalos donde corresponden.

+	5	7	2	9
7		a		a
3				b
4		b		

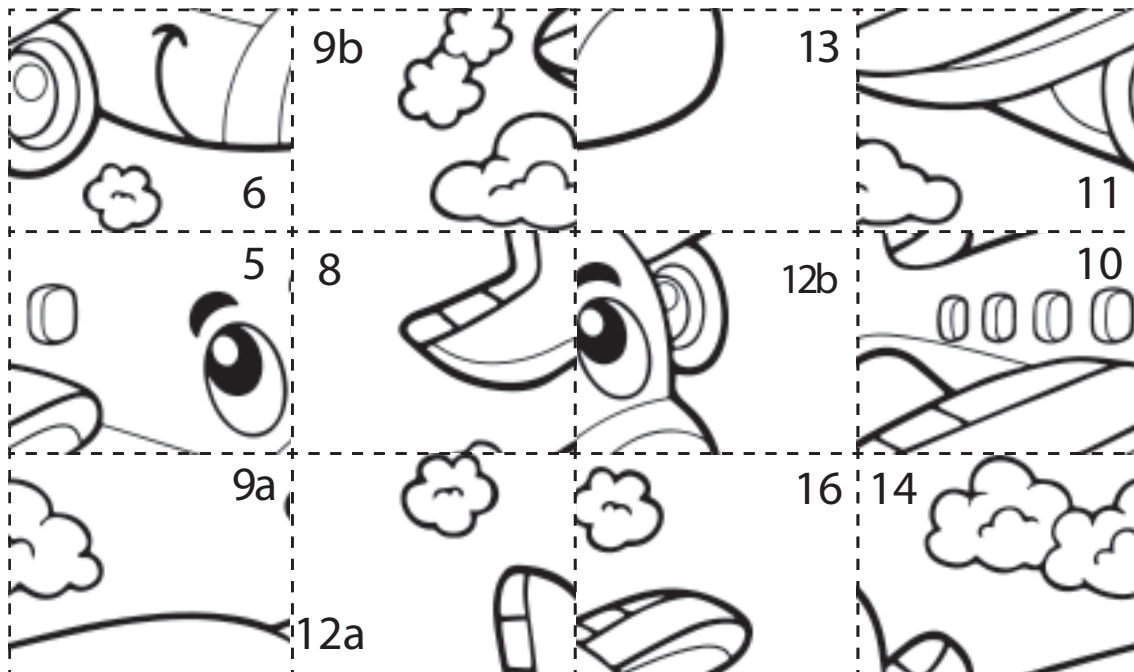

¡SUMA Y RECORTA!

Escribe el resultado en la SUMA, después recorta los resultados y pégalos donde corresponden.

+	4	5	3	7
5	a			
2				b
9				

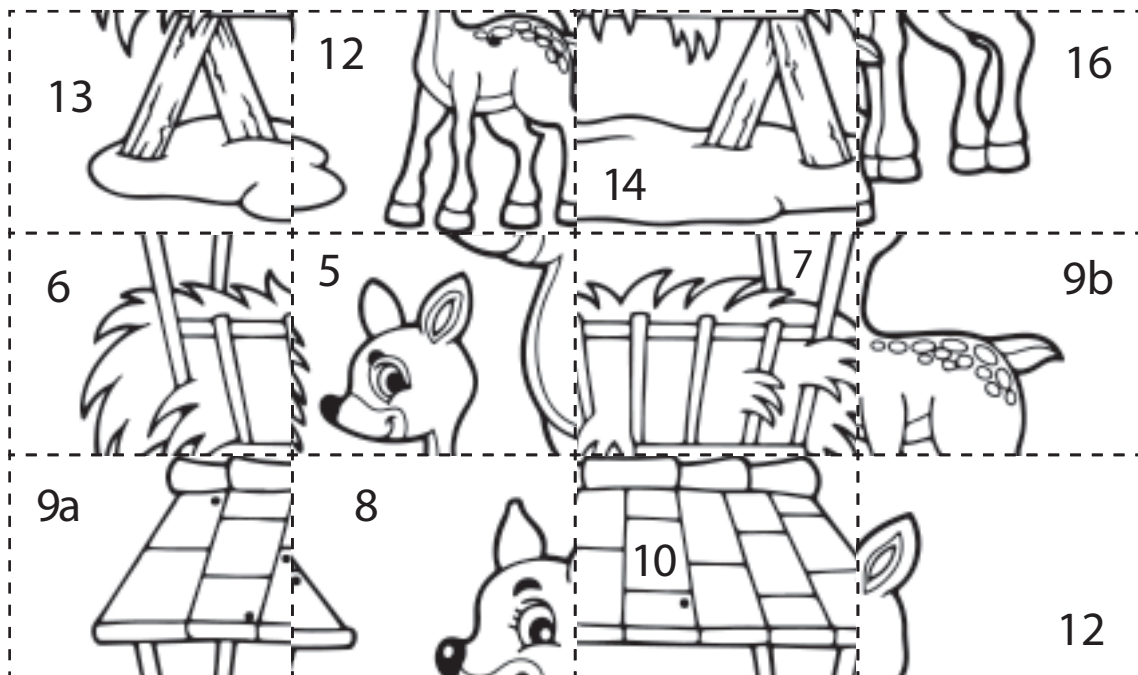

¡SUMA Y RECORTA!

Escribe el resultado en la SUMA, después recorta los resultados y pégalos donde corresponden.

+	13	19	64	21
3				a
8				
5		b		



¡SUMA Y RECORTA!

Escribe el resultado en la SUMA, después recorta los resultados y pégalos donde corresponden.

+	78	24	89	36
7				
26				
38				

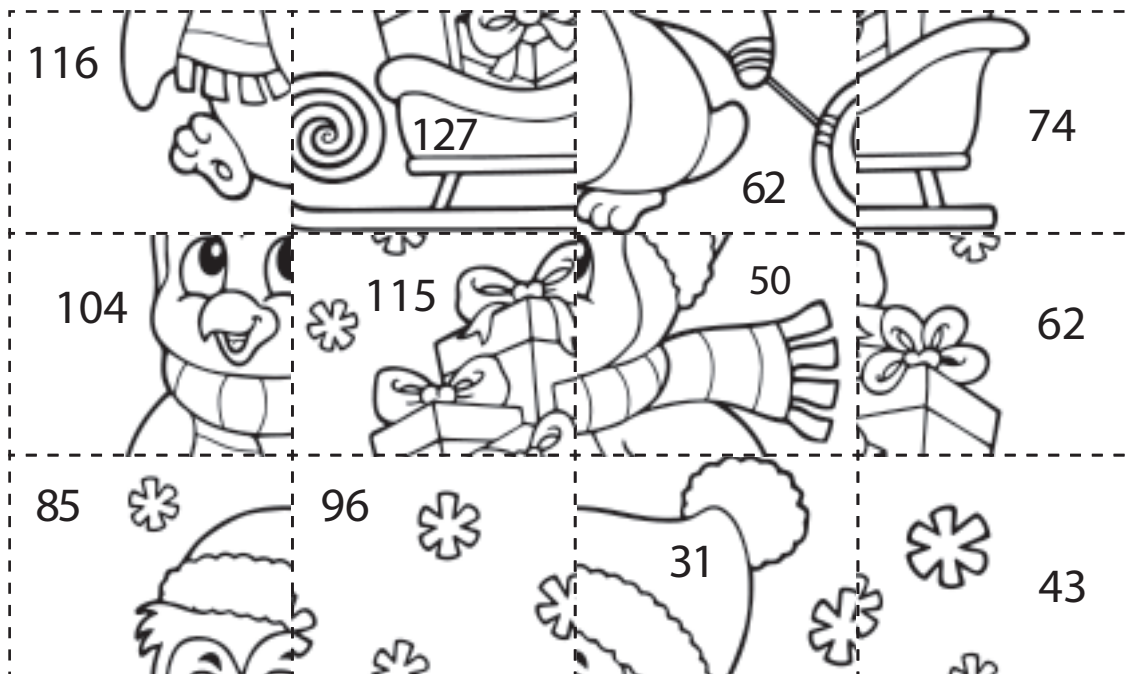







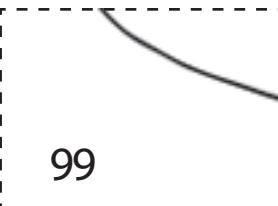
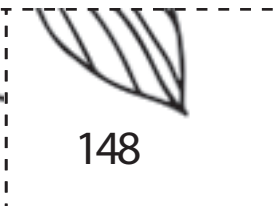

¡SUMA Y RECORTA!

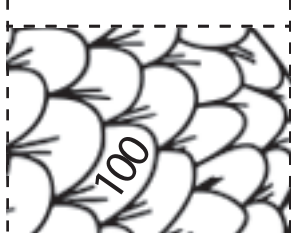
Escribe el resultado en la SUMA, después recorta los resultados y pégalos donde corresponden.

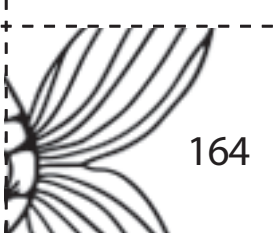
+	44	76	29	93
16				
71				
55				

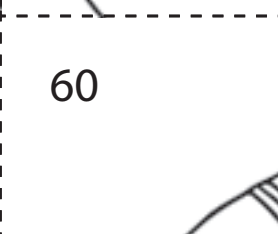
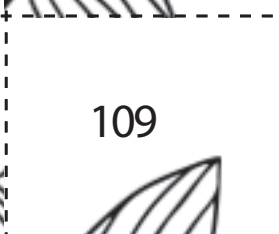

 84	 99	 148	 131
 100	 115	 164	 147
 45	 60	 109	 92



□ + □ = □

□ + □ = □

□ + □ = □

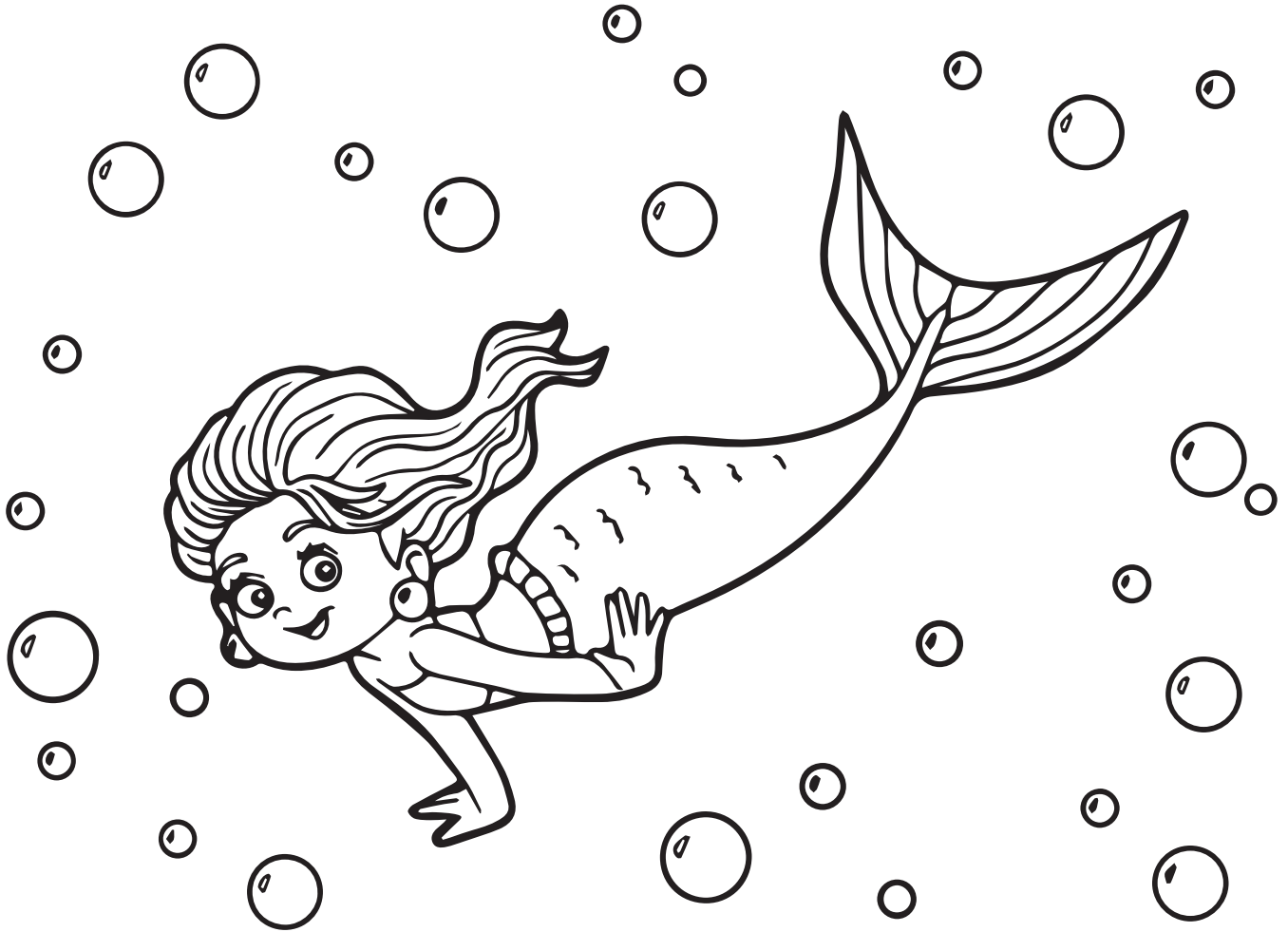

□ + □ = □

□ + □ = □

□ + □ = □

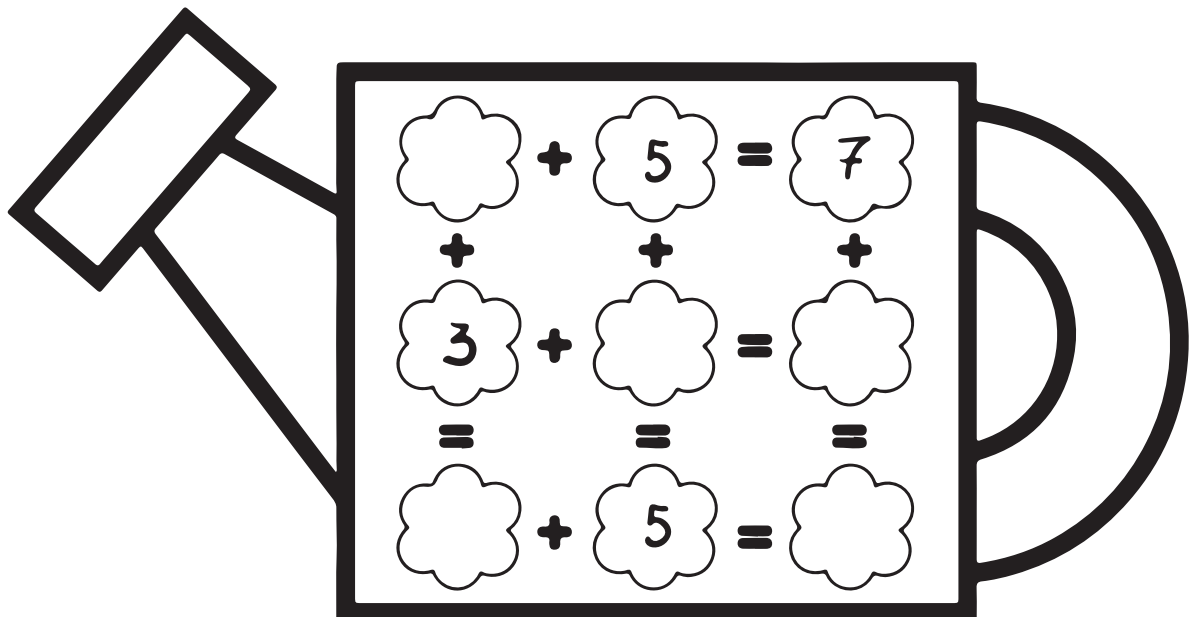
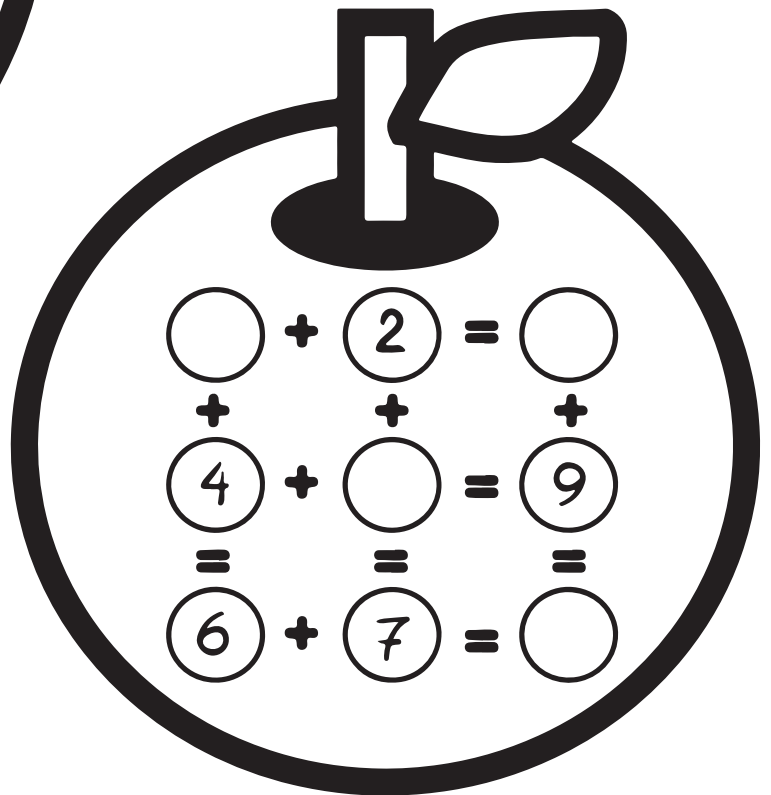
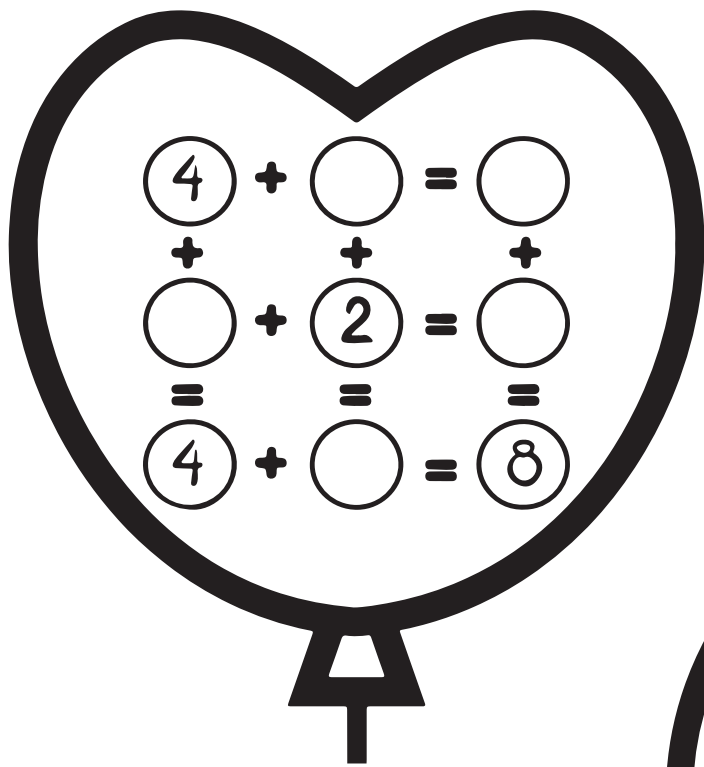

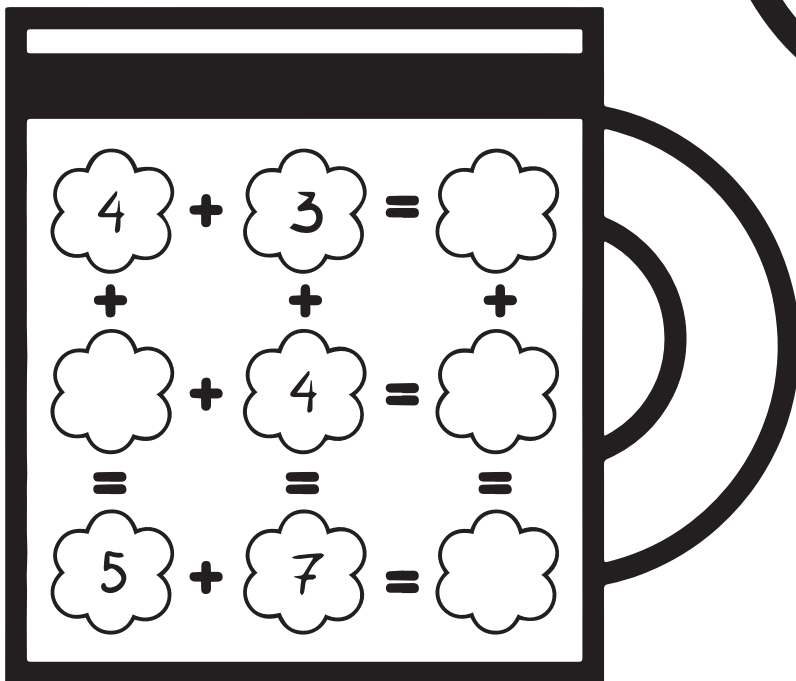
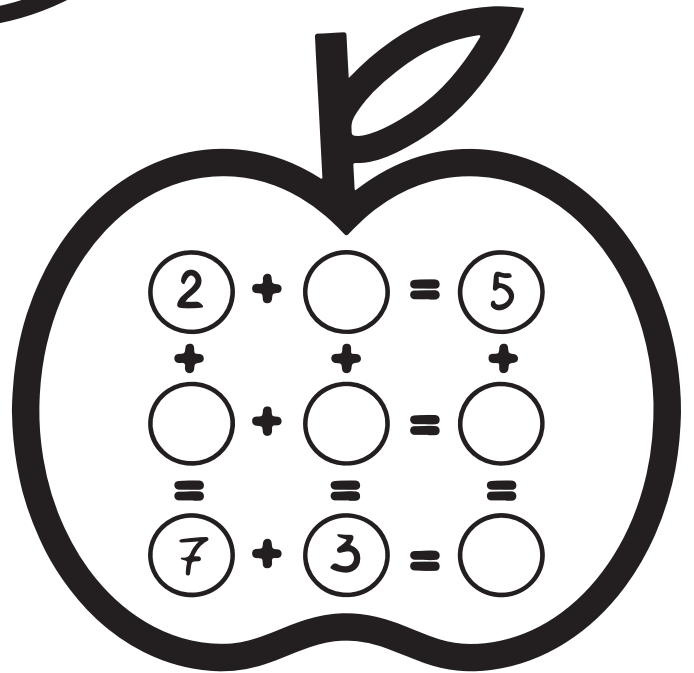
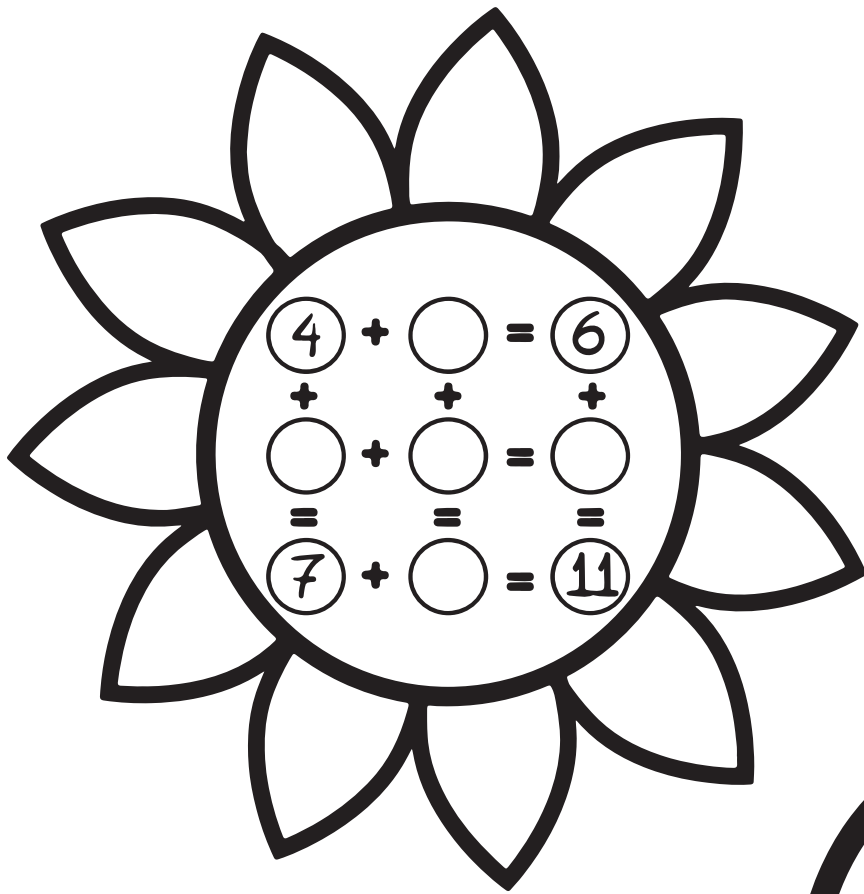

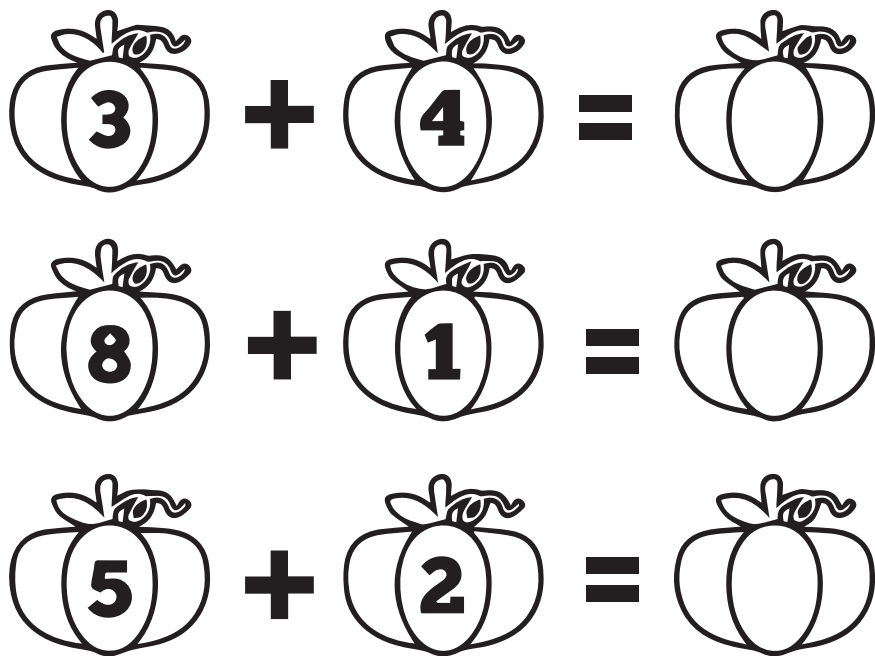
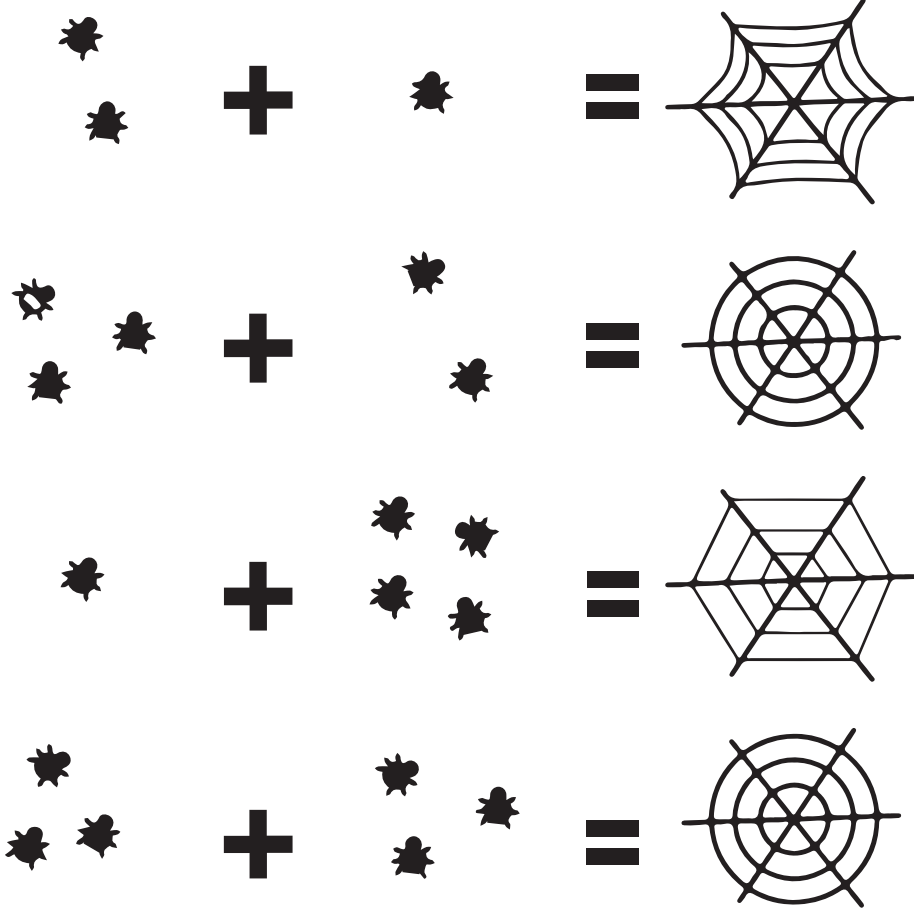

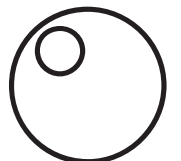
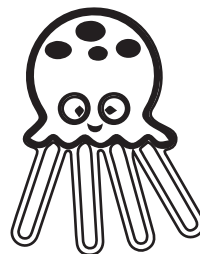
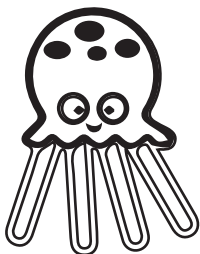
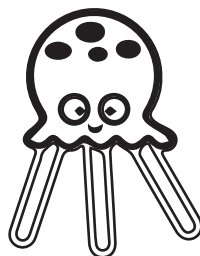
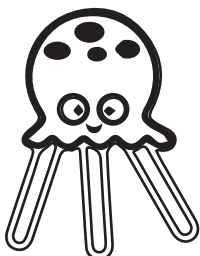
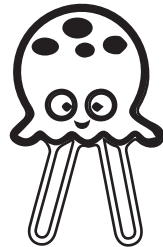
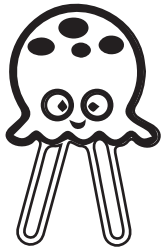
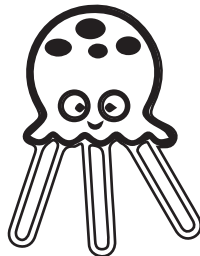
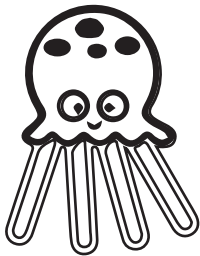
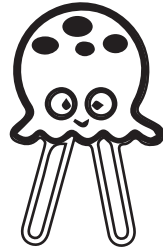
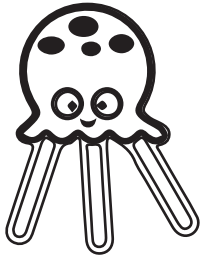
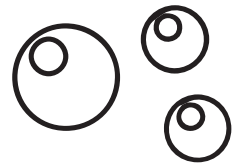
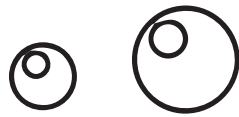
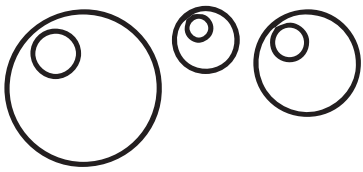

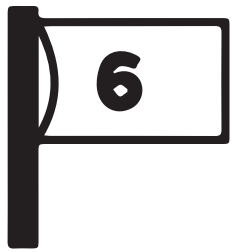
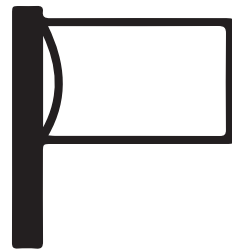

 +  = 

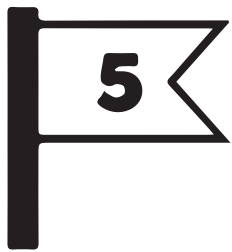
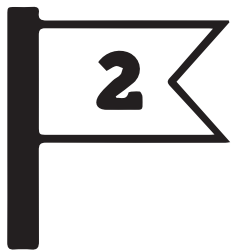
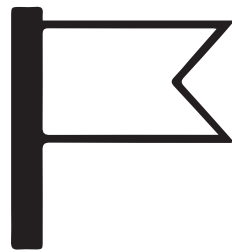
 +  = 

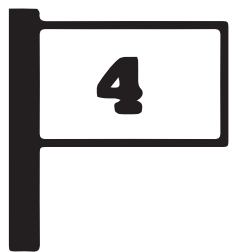
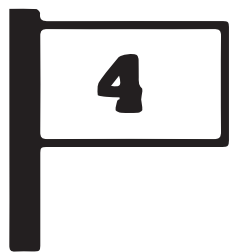
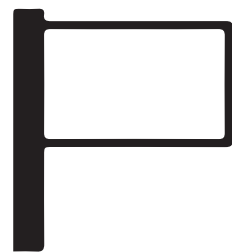
 +  = 

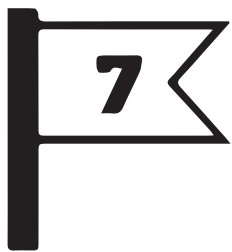
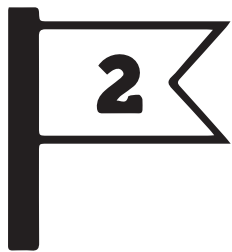
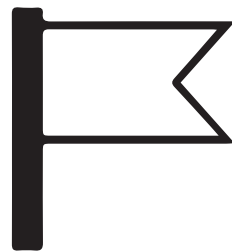
 +  = 

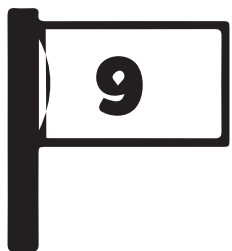
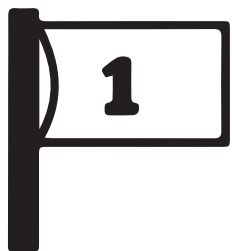
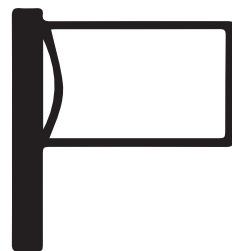
 +  = 

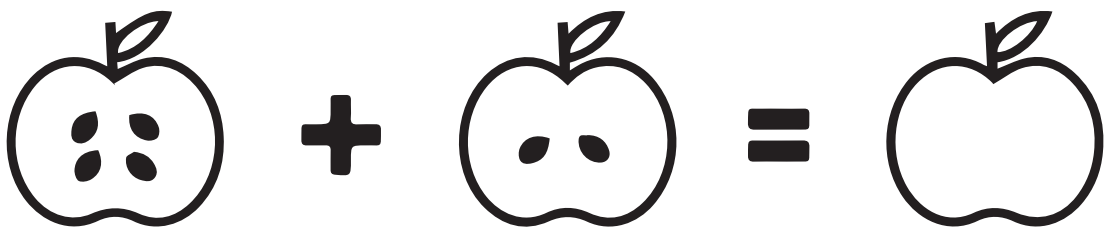
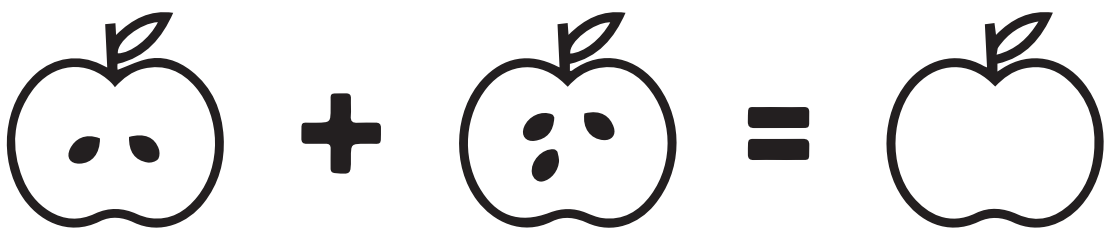
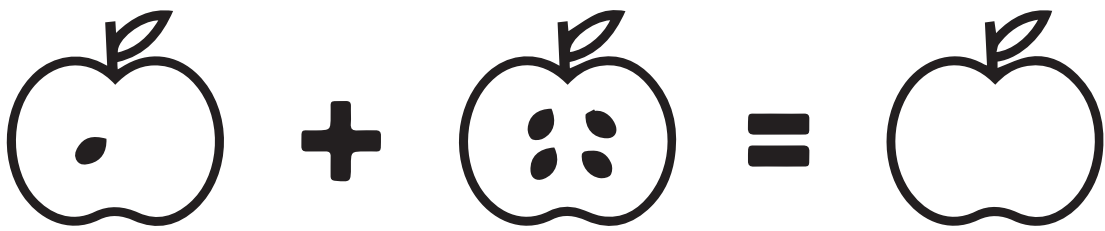
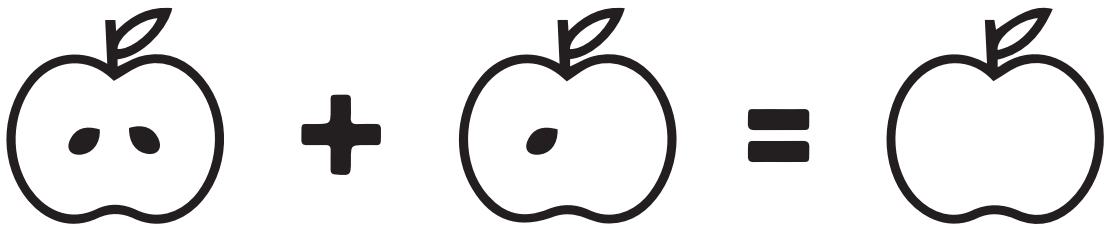
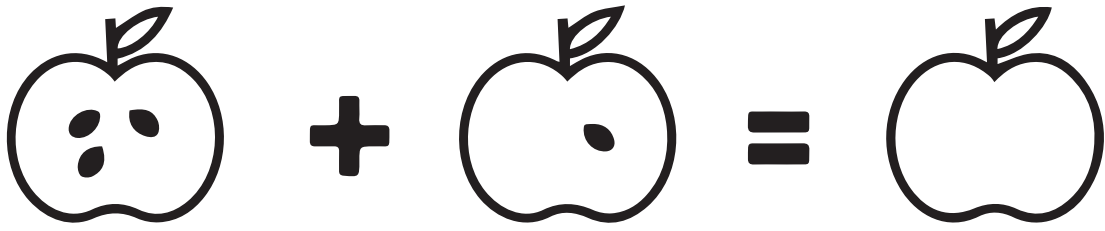

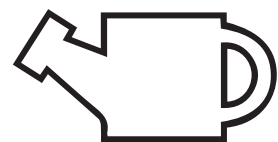
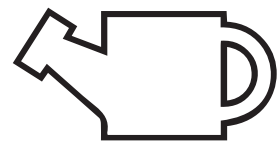
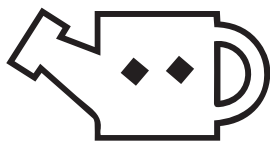
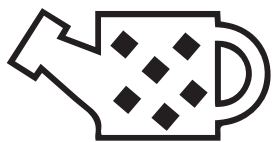
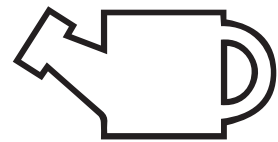
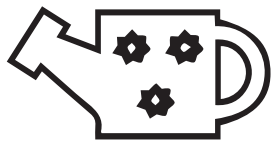
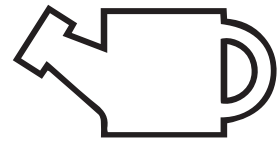
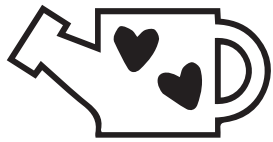
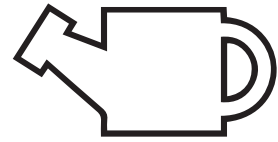
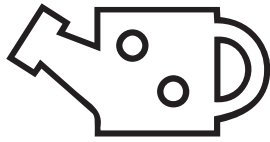
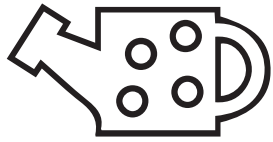

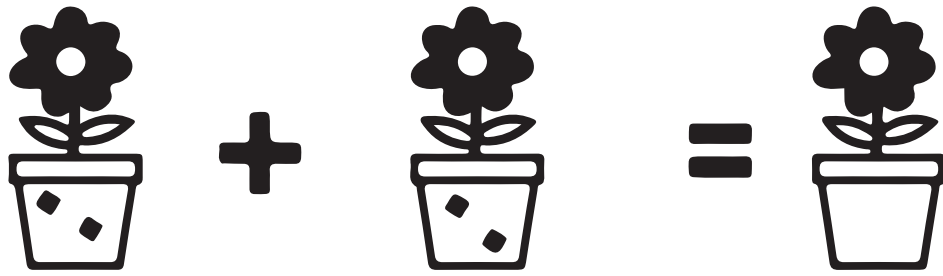

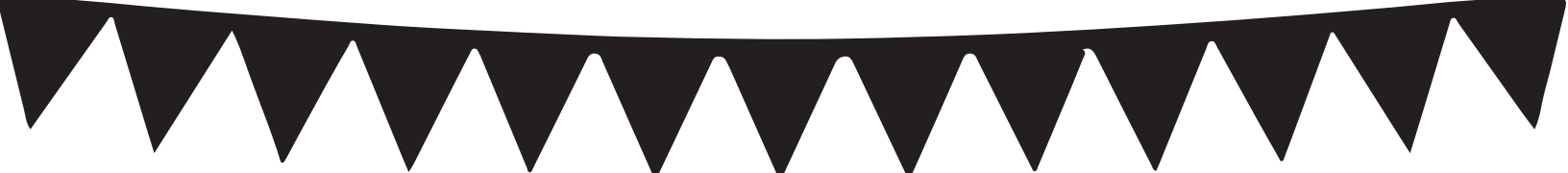

$$\begin{array}{c} \text{flower} \quad \text{flower} \\ | \quad | \\ \text{---} \end{array} + \begin{array}{c} \text{flower} \\ | \\ \text{---} \end{array} = \text{---}$$

$$\begin{array}{c} \text{flower} \quad \text{flower} \\ | \quad | \\ \text{---} \end{array} + \begin{array}{c} \text{flower} \quad \text{flower} \\ | \quad | \\ \text{---} \end{array} = \text{---}$$

$$\begin{array}{c} \text{flower} \quad \text{flower} \\ | \quad | \\ \text{---} \end{array} + \begin{array}{c} \text{flower} \quad \text{flower} \\ | \quad | \\ \text{---} \end{array} = \text{---}$$

$$\begin{array}{c} \text{flower} \\ | \\ \text{---} \end{array} + \begin{array}{c} \text{flower} \quad \text{flower} \\ | \quad | \\ \text{---} \end{array} = \text{---}$$

$$\begin{array}{c} \text{flower} \quad \text{flower} \\ | \quad | \\ \text{---} \end{array} + \begin{array}{c} \text{flower} \quad \text{flower} \\ | \quad | \\ \text{---} \end{array} = \text{---}$$



$$\begin{array}{|c|} \hline \cdot \\ \hline \cdot \\ \hline \cdot \\ \hline \end{array} + \begin{array}{|c|} \hline \cdot \\ \hline \cdot \\ \hline \cdot \\ \hline \end{array} = \begin{array}{|c|} \hline \\ \hline \\ \hline \\ \hline \end{array}$$

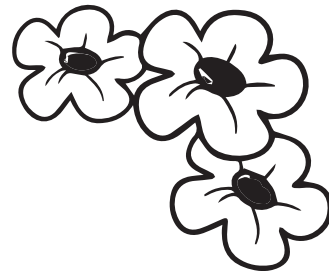



$$\begin{array}{|c|} \hline \cdot \\ \hline \cdot \\ \hline \cdot \\ \hline \end{array} + \begin{array}{|c|} \hline \cdot \\ \hline \cdot \\ \hline \cdot \\ \hline \end{array} = \begin{array}{|c|} \hline \\ \hline \\ \hline \\ \hline \end{array}$$

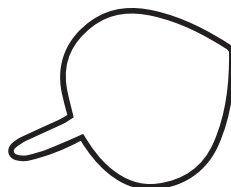
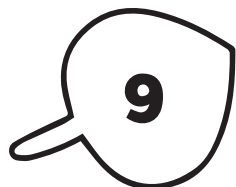
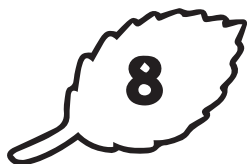
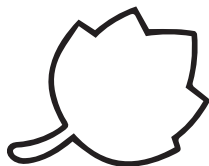
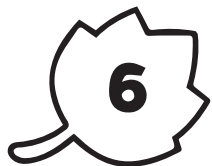
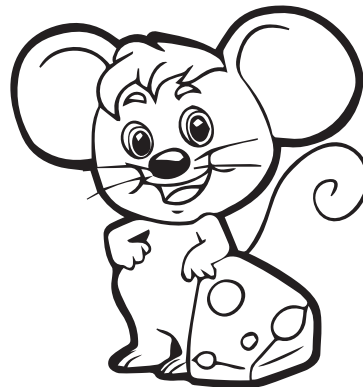

$$\begin{array}{|c|} \hline \cdot \\ \hline \cdot \\ \hline \cdot \\ \hline \end{array} + \begin{array}{|c|} \hline \cdot \\ \hline \cdot \\ \hline \cdot \\ \hline \end{array} = \begin{array}{|c|} \hline \\ \hline \\ \hline \\ \hline \end{array}$$

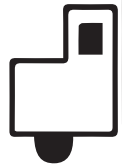

$$\begin{array}{|c|} \hline \cdot \\ \hline \cdot \\ \hline \cdot \\ \hline \end{array} + \begin{array}{|c|} \hline \cdot \\ \hline \cdot \\ \hline \cdot \\ \hline \end{array} = \begin{array}{|c|} \hline \\ \hline \\ \hline \\ \hline \end{array}$$

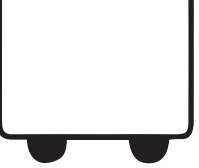







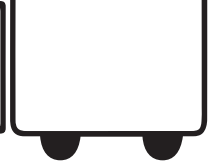

 **37** +  **8** =  

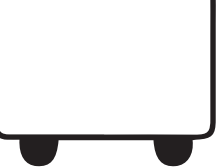
 **24** +  **12** =  

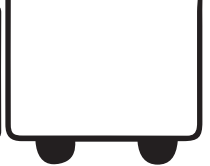

 **68** +  **29** =  

 **95** +  **30** =  

 **46** +  **36** =  



7 + **5** = 

 **4** +  **6** = 

 **2** +  **9** = 

 **8** +  **4** = 

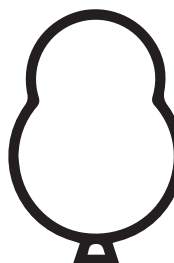
 **3** +  **5** = 

$$\begin{array}{c} \boxed{2} \\ \text{stick} \end{array} + \begin{array}{c} \boxed{6} \\ \text{stick} \end{array} = \begin{array}{c} \boxed{} \\ \text{stick} \end{array}$$

$$\begin{array}{c} \boxed{3} \\ \text{stick} \end{array} + \begin{array}{c} \boxed{4} \\ \text{stick} \end{array} = \begin{array}{c} \boxed{} \\ \text{stick} \end{array}$$

$$\begin{array}{c} \boxed{9} \\ \text{stick} \end{array} + \begin{array}{c} \boxed{1} \\ \text{stick} \end{array} = \begin{array}{c} \boxed{} \\ \text{stick} \end{array}$$

$$\begin{array}{c} \boxed{5} \\ \text{stick} \end{array} + \begin{array}{c} \boxed{2} \\ \text{stick} \end{array} = \begin{array}{c} \boxed{} \\ \text{stick} \end{array}$$

$$\begin{array}{c} \boxed{1} \\ \text{stick} \end{array} + \begin{array}{c} \boxed{5} \\ \text{stick} \end{array} = \begin{array}{c} \boxed{} \\ \text{stick} \end{array}$$

$$\begin{array}{c} \text{12} \\ \text{+} \\ \text{5} \\ \text{=} \end{array}$$



$$\begin{array}{c} \text{6} \\ \text{+} \\ \text{11} \\ \text{=} \end{array}$$

$$\begin{array}{c} \text{10} \\ \text{+} \\ \text{8} \\ \text{=} \end{array}$$



$$\begin{array}{c} \text{14} \\ \text{+} \\ \text{2} \\ \text{=} \end{array}$$



$$\begin{array}{c} \text{7} \\ \text{+} \\ \text{13} \\ \text{=} \end{array}$$



+

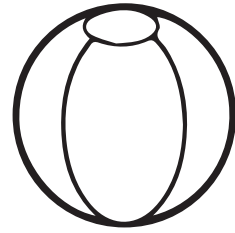

=



+



=

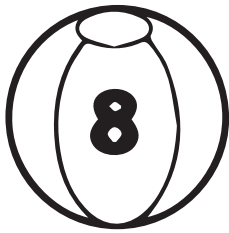
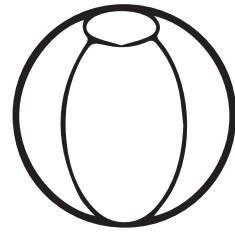

+



=

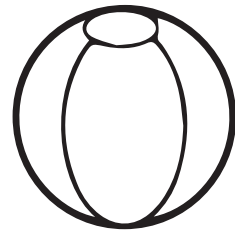

+



=

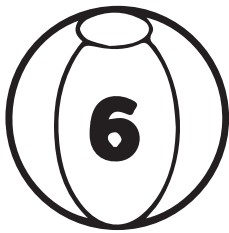
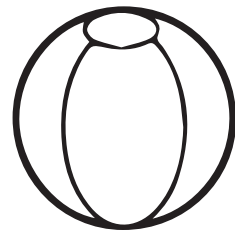

+



=

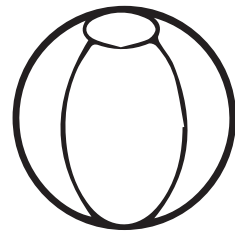

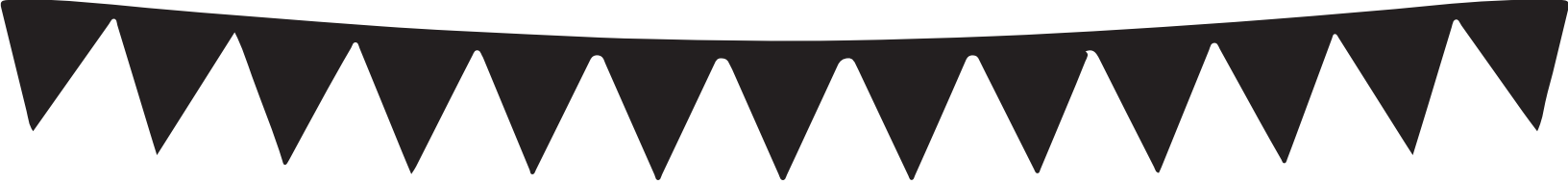

+ =

+ =

+ =

+ =

+ =

+ =

+ =

+ =

+ =

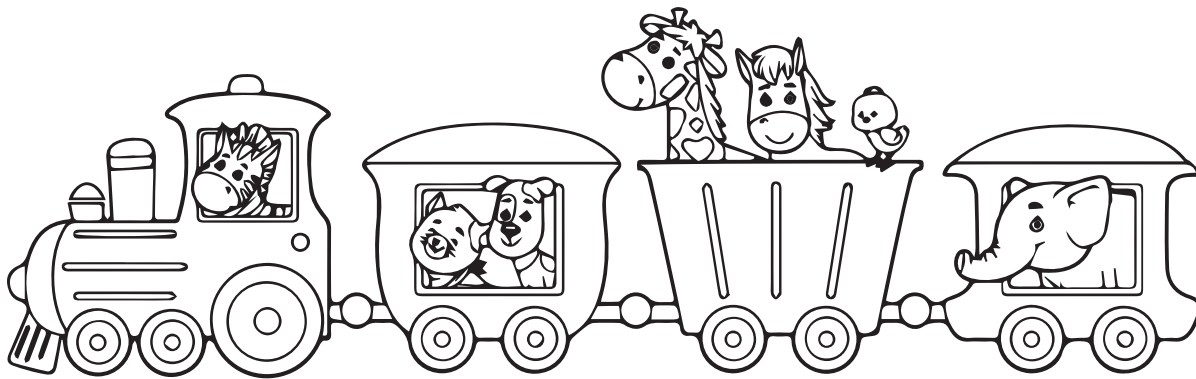

$$1 + 2 + 3 + 1 =$$

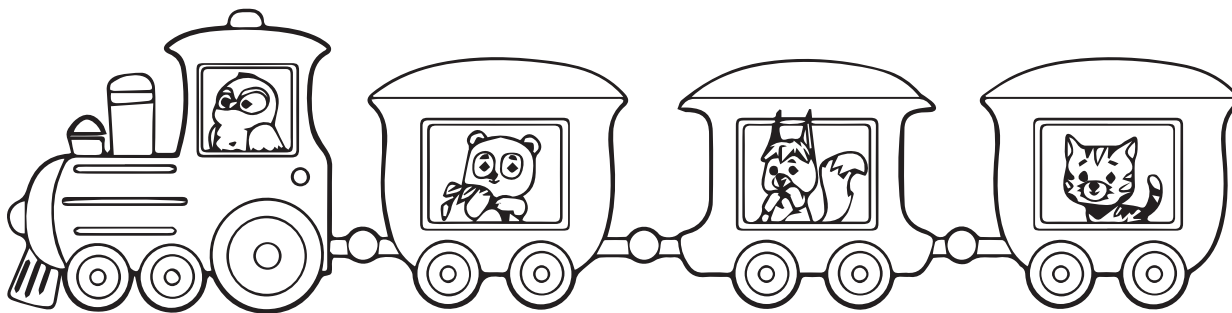

$$1 + 1 + 1 + 1 =$$

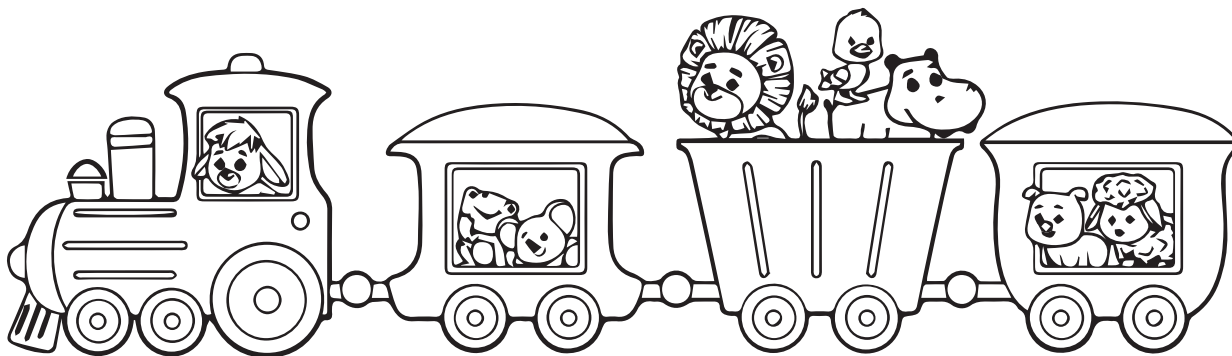

$$1 + 2 + 3 + 2 =$$

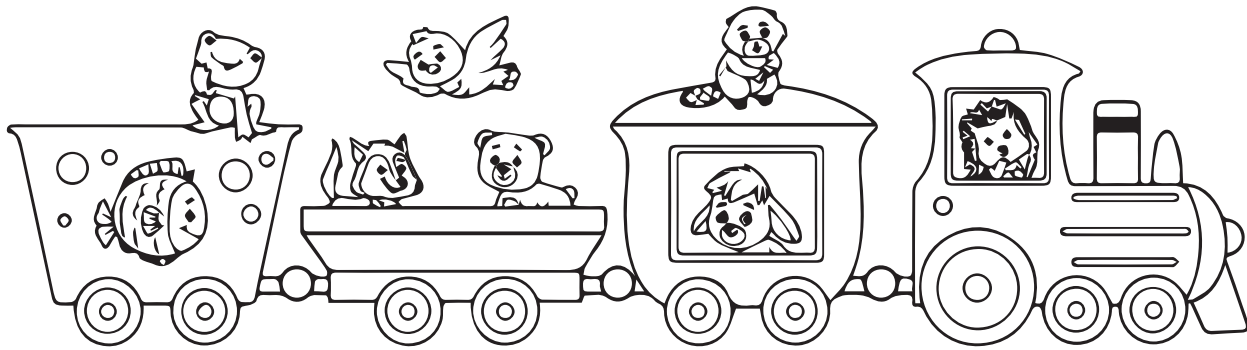

$$2 + 3 + 2 + 1 = \square$$

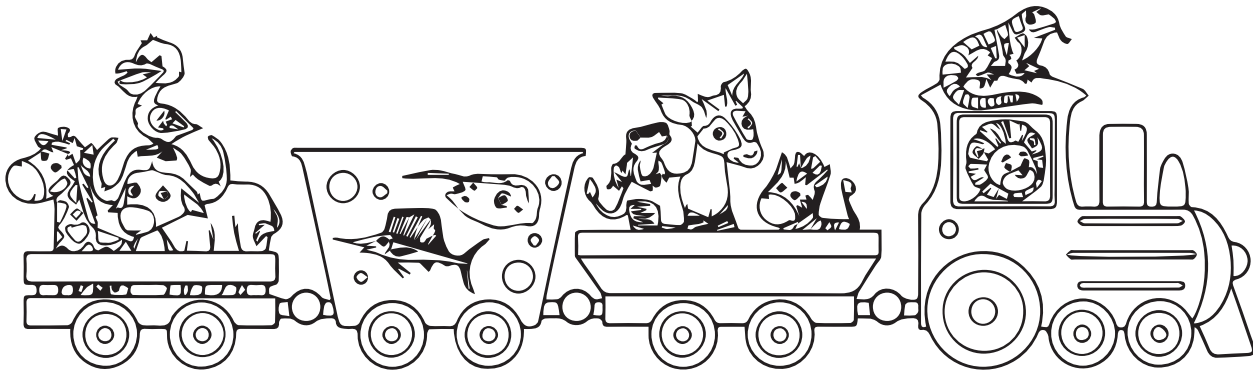
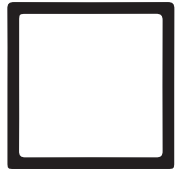

$$3 + 2 + 3 + 2 = \square$$

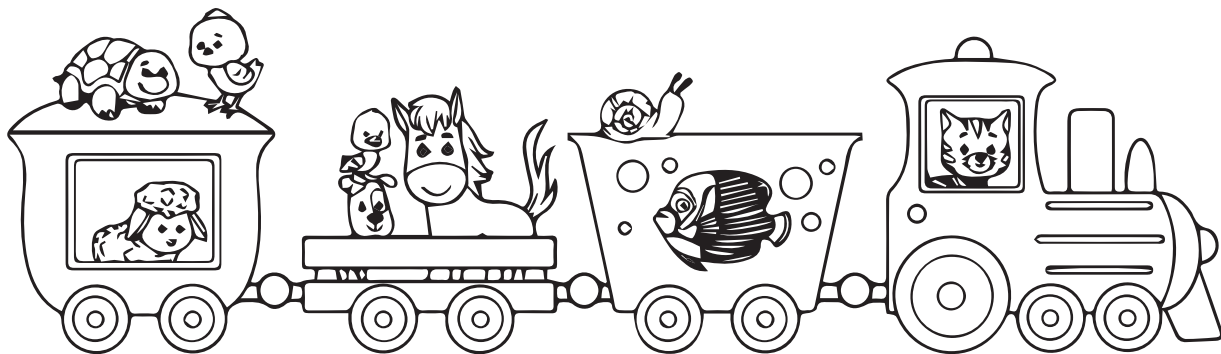
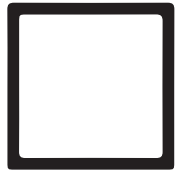

$$3 + 3 + 2 + 1 = \square$$



$$\boxed{5} + \boxed{2} + \boxed{4} = \boxed{}$$

$$\boxed{2} + \boxed{6} + \boxed{1} = \boxed{}$$

$$\boxed{5} + \boxed{3} + \boxed{2} = \boxed{}$$

$$\boxed{6} + \boxed{1} + \boxed{5} = \boxed{}$$

$$\boxed{3} + \boxed{9} + \boxed{6} = \boxed{}$$

$$\boxed{7} + \boxed{8} + \boxed{4} = \boxed{}$$

www.materialparamaestros.com

12

10

19

11

18

9

$$\boxed{9} + \boxed{6} + \boxed{7} = \boxed{}$$

$$\boxed{3} + \boxed{9} + \boxed{6} = \boxed{}$$

$$\boxed{4} + \boxed{8} + \boxed{5} = \boxed{}$$

$$\boxed{9} + \boxed{2} + \boxed{9} = \boxed{}$$

$$\boxed{5} + \boxed{1} + \boxed{8} = \boxed{}$$

$$\boxed{6} + \boxed{9} + \boxed{9} = \boxed{}$$

www.materialparamaestros.com

17

22

20

24

18

14

$$\boxed{13} + \boxed{9} + \boxed{11} = \boxed{}$$

$$\boxed{14} + \boxed{15} + \boxed{7} = \boxed{}$$

$$\boxed{6} + \boxed{12} + \boxed{11} = \boxed{}$$

$$\boxed{16} + \boxed{18} + \boxed{10} = \boxed{}$$

$$\boxed{10} + \boxed{19} + \boxed{13} = \boxed{}$$

$$\boxed{15} + \boxed{19} + \boxed{18} = \boxed{}$$

www.materialparamaestros.com

36

44

52

42

29

33

$$\boxed{54} + \boxed{32} + \boxed{14} = \boxed{}$$

$$\boxed{25} + \boxed{60} + \boxed{53} = \boxed{}$$

$$\boxed{45} + \boxed{80} + \boxed{22} = \boxed{}$$

$$\boxed{62} + \boxed{74} + \boxed{9} = \boxed{}$$

$$\boxed{11} + \boxed{40} + \boxed{60} = \boxed{}$$

$$\boxed{25} + \boxed{78} + \boxed{93} = \boxed{}$$

www.materialparamaestros.com

196

138

145

111

100

147

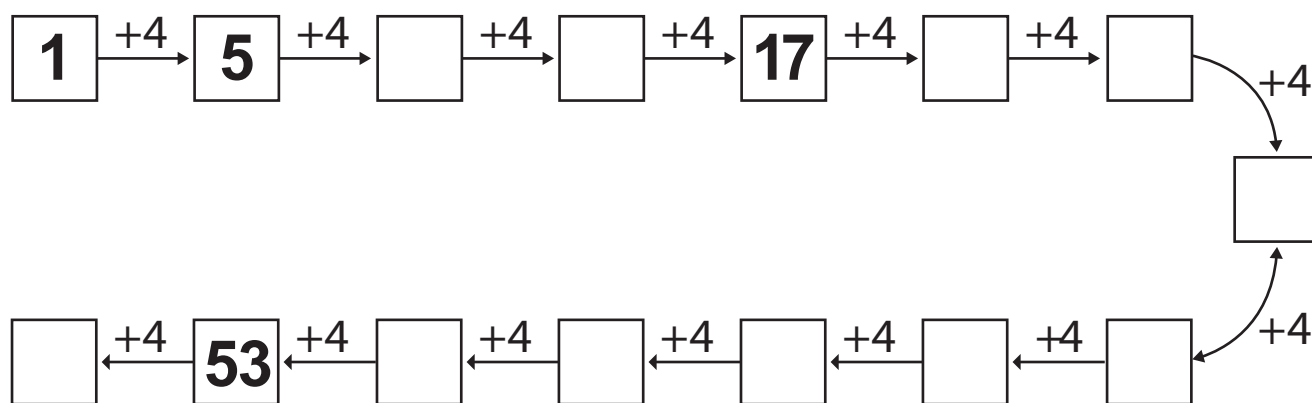
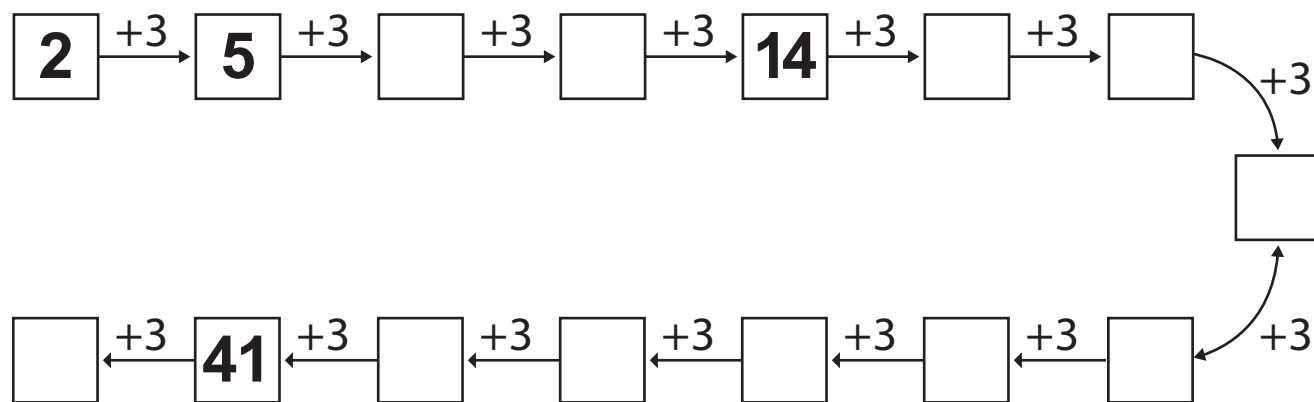
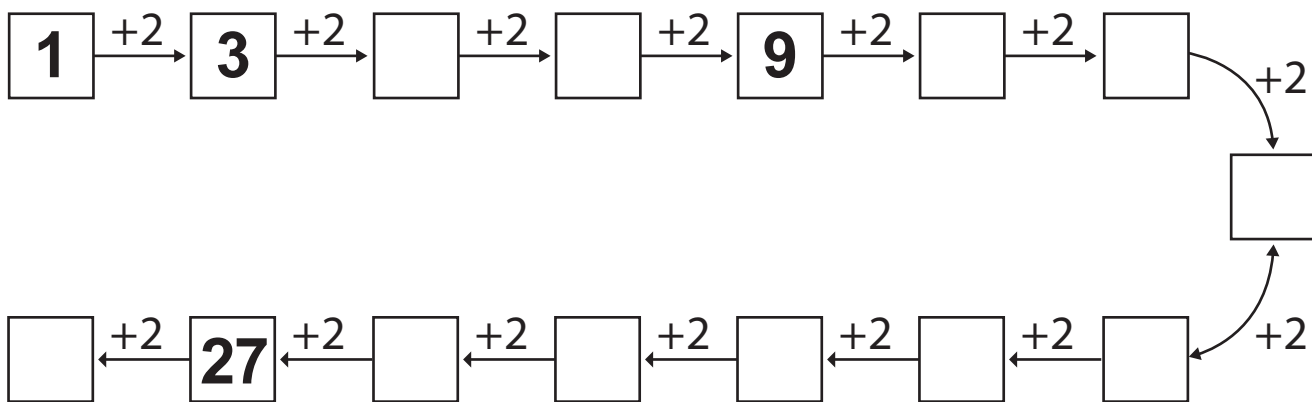

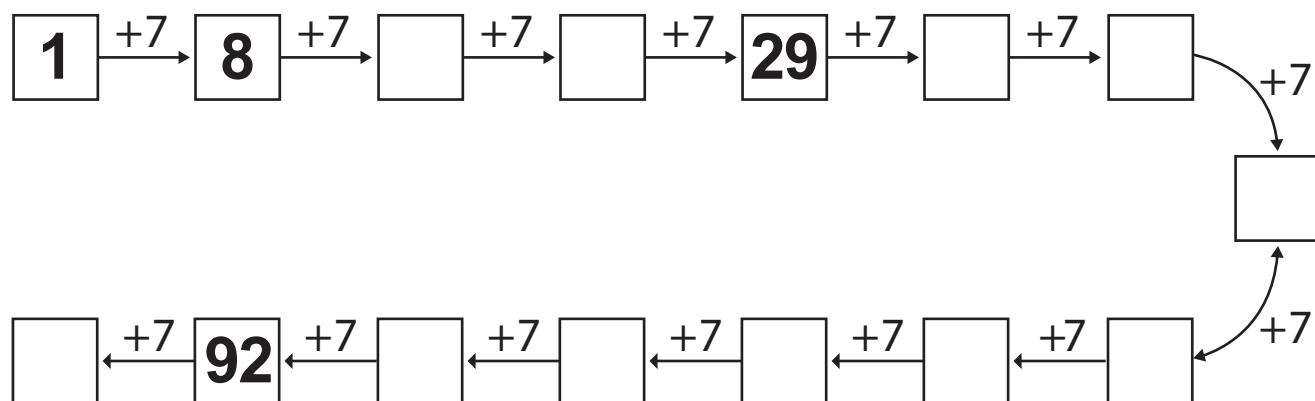
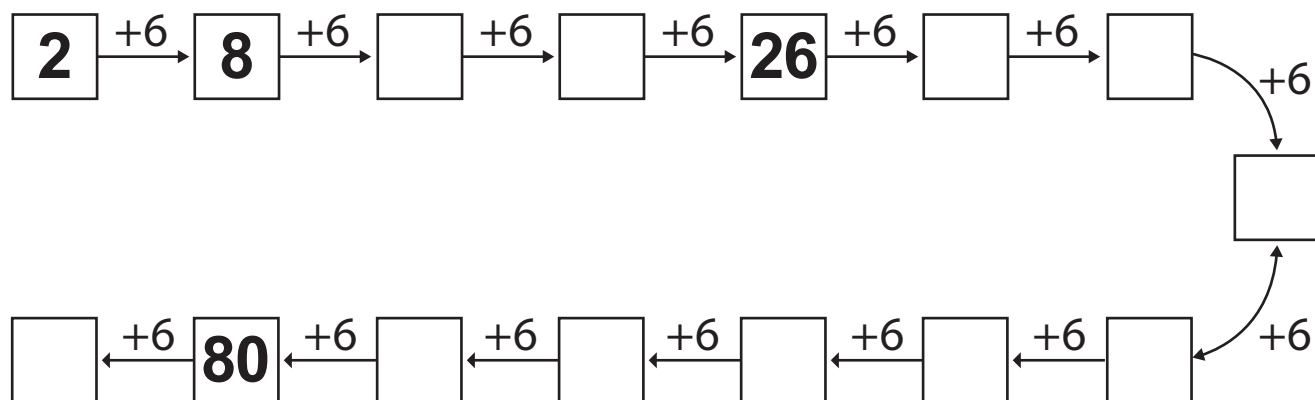
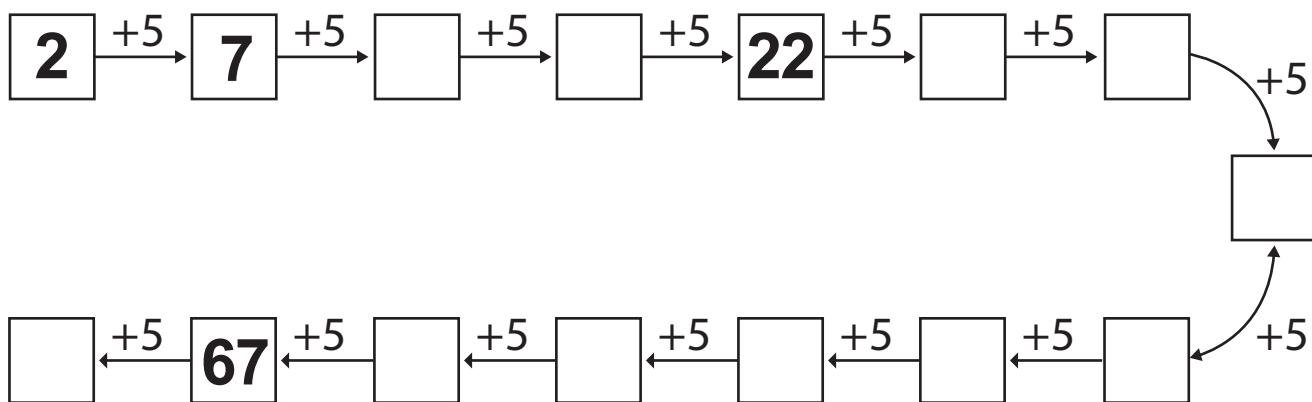

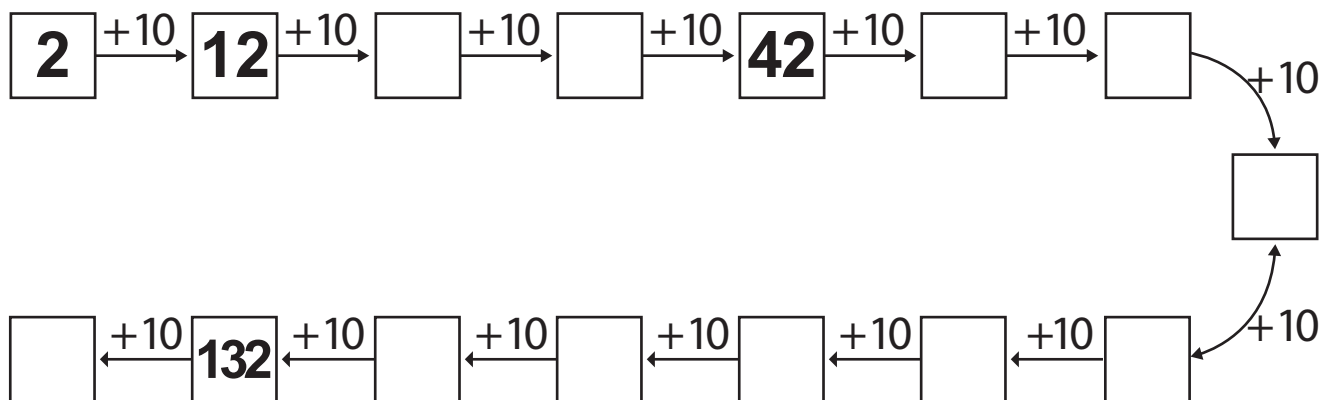
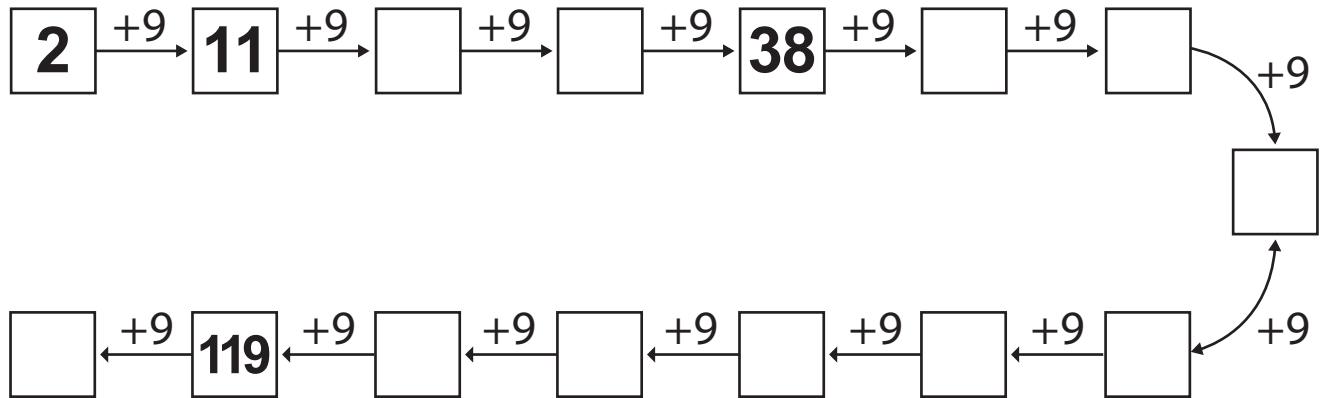
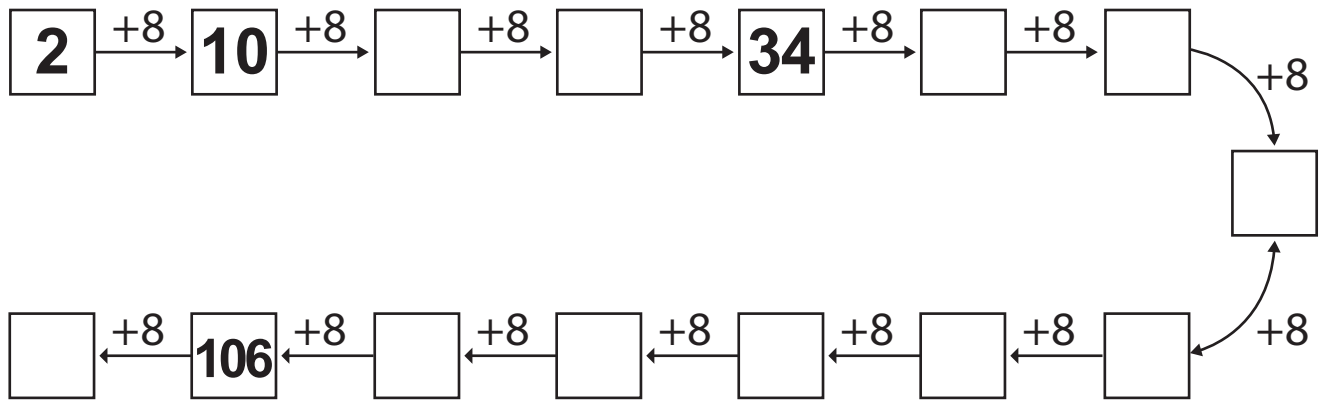

$$\begin{array}{r} 58 \\ + 5 \\ \hline \square \end{array}$$

$$\begin{array}{r} 36 \\ + 89 \\ \hline \square \end{array}$$

$$\begin{array}{r} 19 \\ + 34 \\ \hline \square \end{array}$$

$$\begin{array}{r} 56 \\ + 5 \\ \hline \square \end{array}$$

$$\begin{array}{r} 89 \\ + 5 \\ \hline \square \end{array}$$

$$\begin{array}{r} 13 \\ + 9 \\ \hline \square \end{array}$$

$$\begin{array}{r} 20 \\ + 57 \\ \hline \square \end{array}$$

$$\begin{array}{r} 67 \\ + 39 \\ \hline \square \end{array}$$

$$\begin{array}{r} 33 \\ + 46 \\ \hline \square \end{array}$$

$$\begin{array}{r} 89 \\ + 11 \\ \hline \square \end{array}$$

$$\begin{array}{r} 34 \\ + 29 \\ \hline \square \end{array}$$

$$\begin{array}{r} 90 \\ + 19 \\ \hline \square \end{array}$$

$$\begin{array}{r} 78 \\ + 18 \\ \hline \square \end{array}$$

$$\begin{array}{r} 55 \\ + 38 \\ \hline \square \end{array}$$

$$\begin{array}{r} 44 \\ + 65 \\ \hline \square \end{array}$$

$$\begin{array}{r} 34 \\ + 46 \\ \hline \square \end{array}$$

$$\begin{array}{r} 67 \\ + 53 \\ \hline \square \end{array}$$

$$\begin{array}{r} 23 \\ + 28 \\ \hline \square \end{array}$$

$$\begin{array}{r} 66 \\ + 38 \\ \hline \square \end{array}$$

$$\begin{array}{r} 75 \\ + 25 \\ \hline \square \end{array}$$

$$\begin{array}{r} 45 \\ + 7 \\ \hline \square \end{array}$$

$$\begin{array}{r} 78 \\ + 6 \\ \hline \square \end{array}$$

$$\begin{array}{r} 34 \\ + 25 \\ \hline \square \end{array}$$

$$\begin{array}{r} 55 \\ + 5 \\ \hline \square \end{array}$$

$$\begin{array}{r} 89 \\ + 16 \\ \hline \square \end{array}$$

$$\begin{array}{r} 49 \\ + 56 \\ \hline \square \end{array}$$

$$\begin{array}{r} 28 \\ + 78 \\ \hline \square \end{array}$$

$$\begin{array}{r} 33 \\ + 25 \\ \hline \square \end{array}$$

$$\begin{array}{r} 46 \\ + 56 \\ \hline \square \end{array}$$

$$\begin{array}{r} 30 \\ + 39 \\ \hline \square \end{array}$$

$$\begin{array}{r} 89 \\ + 38 \\ \hline \square \end{array}$$

$$\begin{array}{r} 30 \\ + 78 \\ \hline \square \end{array}$$

$$\begin{array}{r} 52 \\ + 89 \\ \hline \square \end{array}$$

$$\begin{array}{r} 75 \\ + 25 \\ \hline \square \end{array}$$

$$\begin{array}{r} 66 \\ + 33 \\ \hline \square \end{array}$$

$$\begin{array}{r} 15 \\ + 56 \\ \hline \square \end{array}$$

$$\begin{array}{r} 56 \\ + 28 \\ \hline \square \end{array}$$

$$\begin{array}{r} 44 \\ + 13 \\ \hline \square \end{array}$$

$$\begin{array}{r} 99 \\ + 20 \\ \hline \square \end{array}$$

$$\begin{array}{r} 56 \\ + 17 \\ \hline \square \end{array}$$