

CUADERNILLO DE
Los números

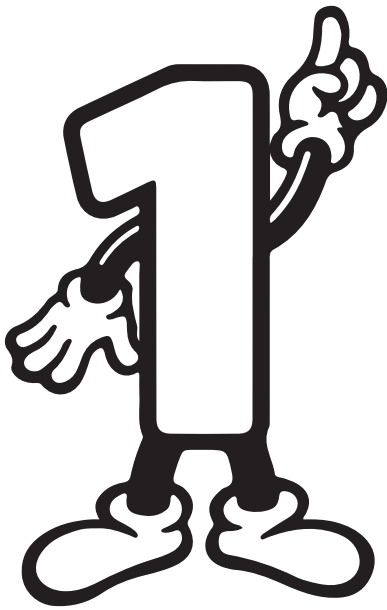

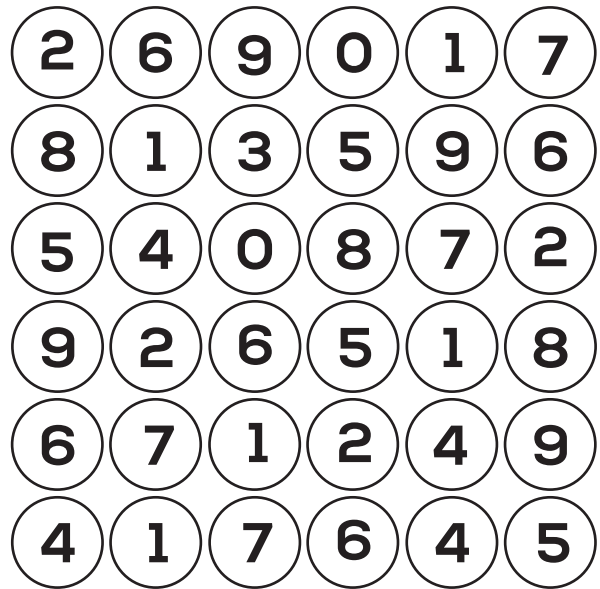

Colorea el número.



Traza y escribe.

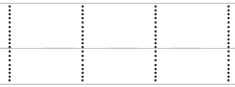

Uno Uno

Colorea uno.

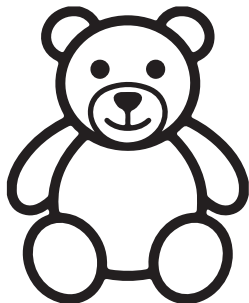



Colorea el número.

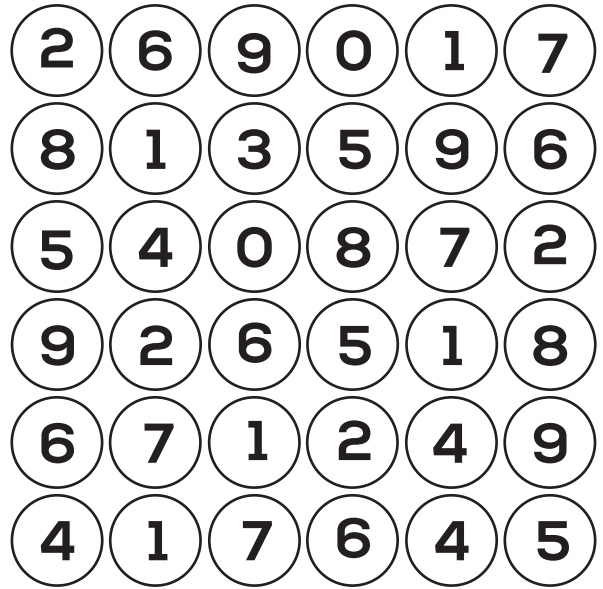

Traza y escribe.

2 2 2

2 2 2

Dos Dos

Colorea dos.

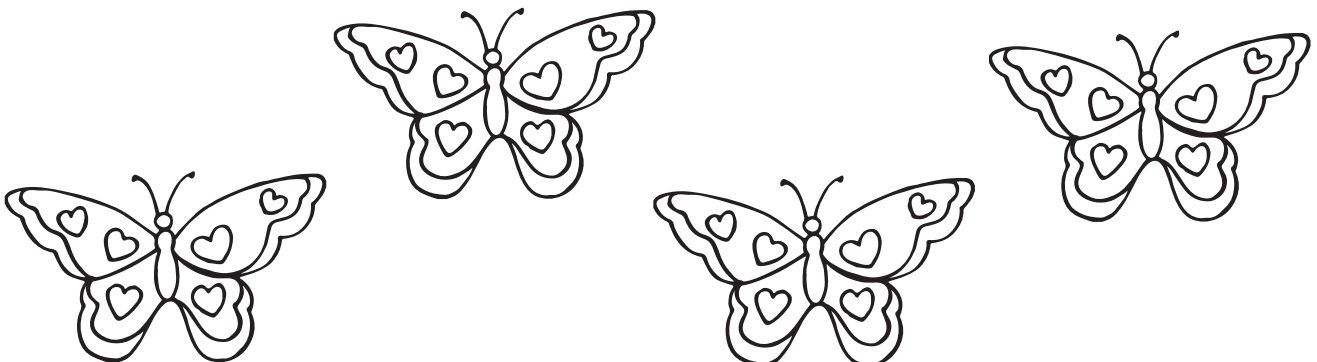

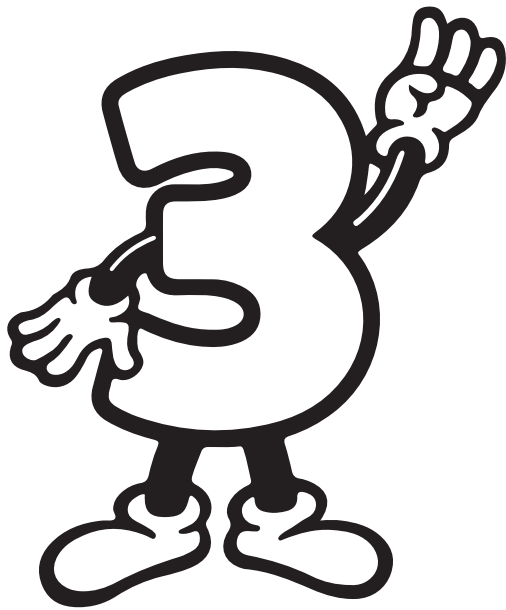

Colorea el número.

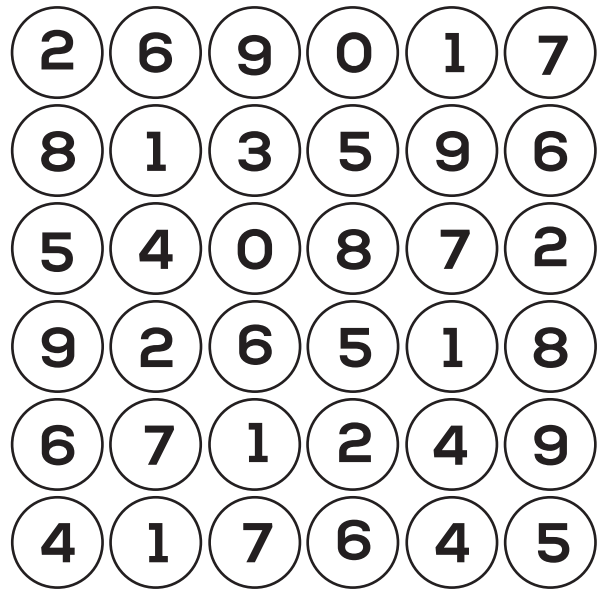

Traza y escribe.



Tres Tres

Colorea tres.





Colorea el número.

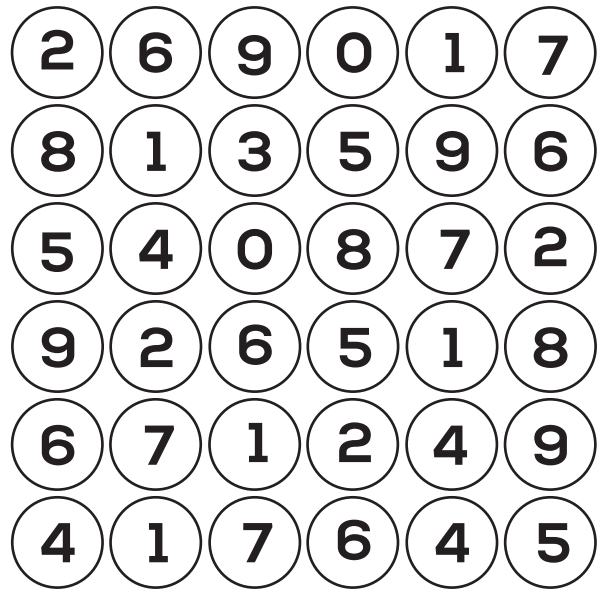

Traza y escribe.

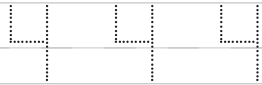

Cuatro Cuatro

Colorea cuatro.

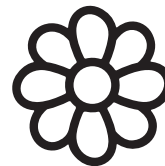
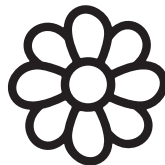
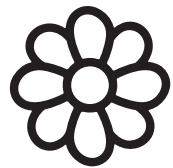
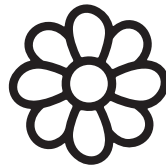
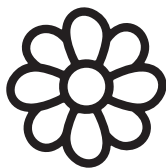
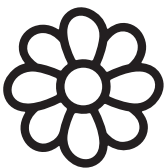



Colorea el número.

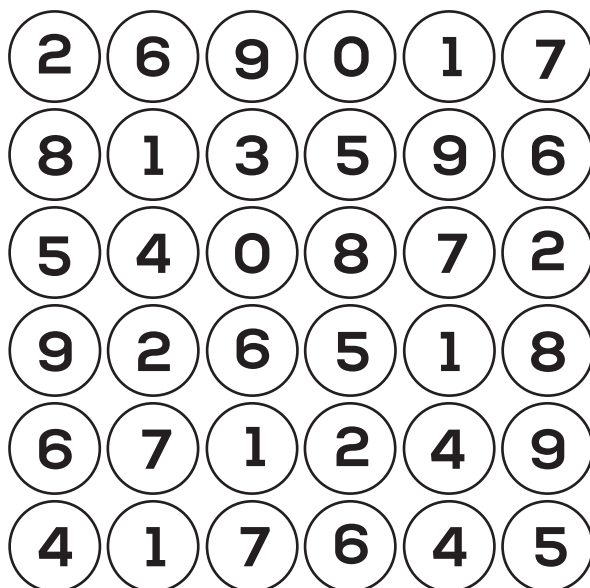

Traza y escribe.

5 5 5

5 5 5

Cinco Cinco

Colorea cinco.

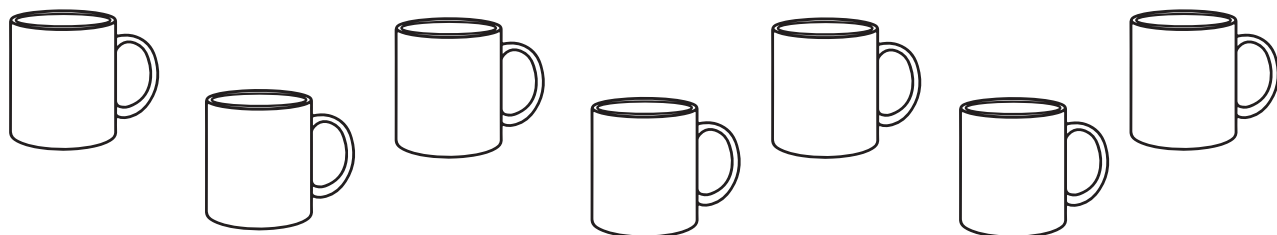

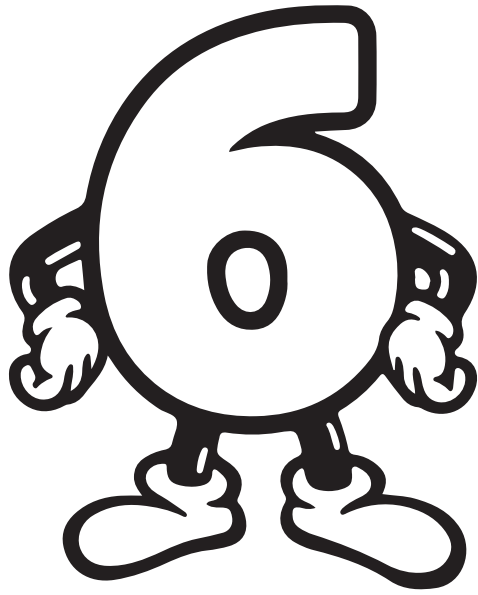

Colorea el número.

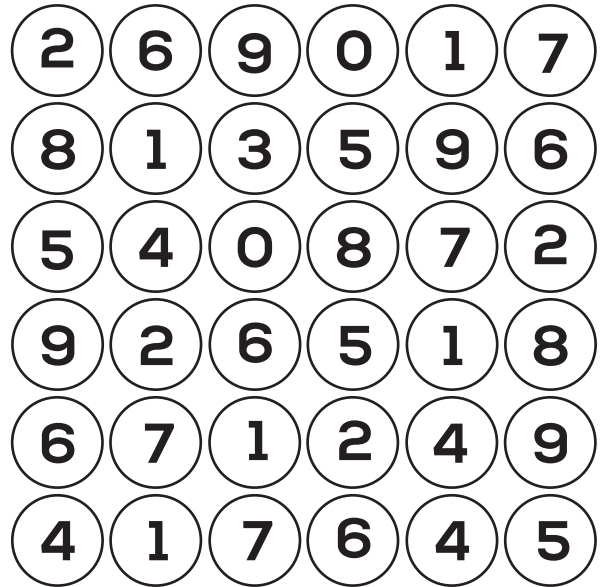

Traza y escribe.



Seis Seis

Colorea seis.

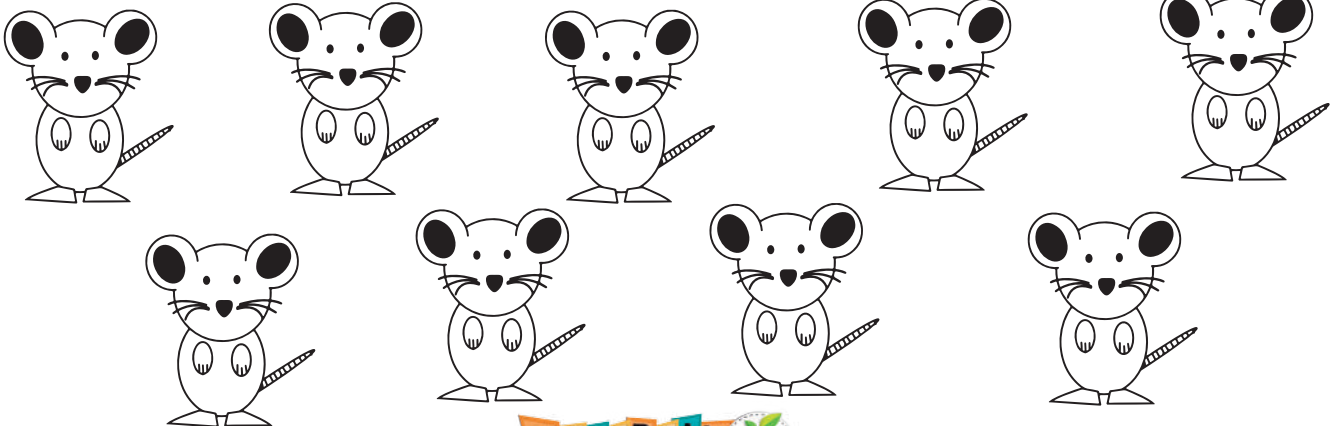



Colorea el número.

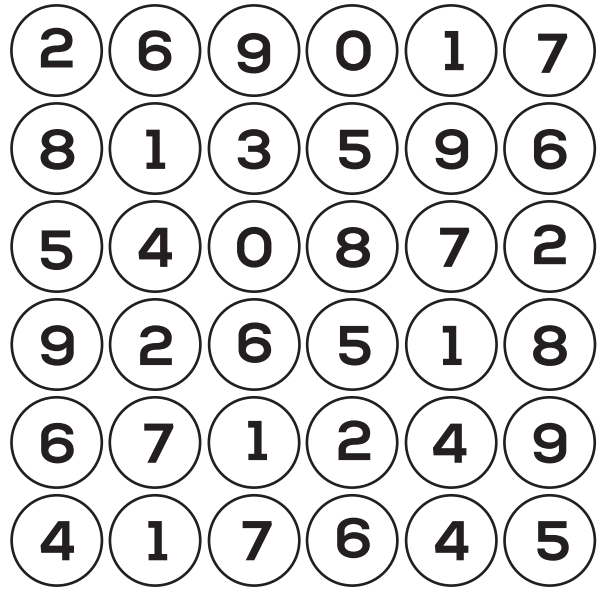

Traza y escribe.



Siete Siete

Colorea siete.

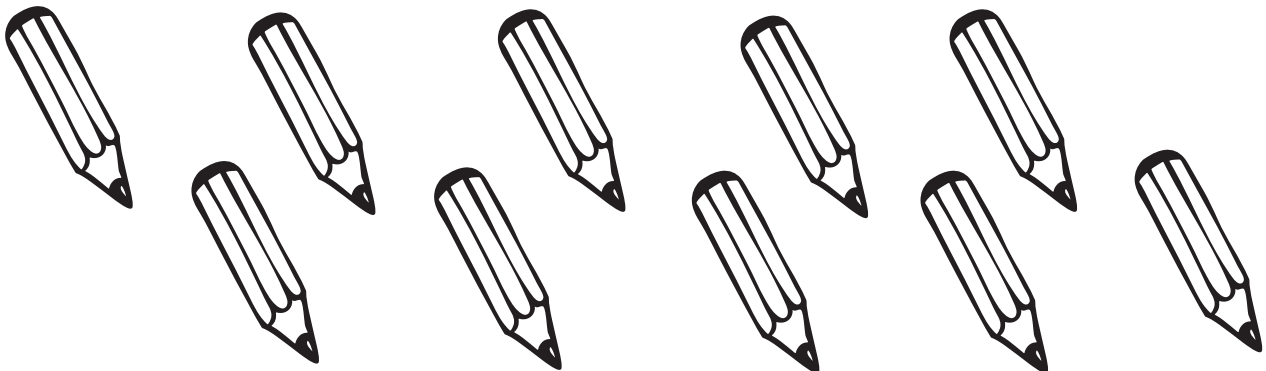

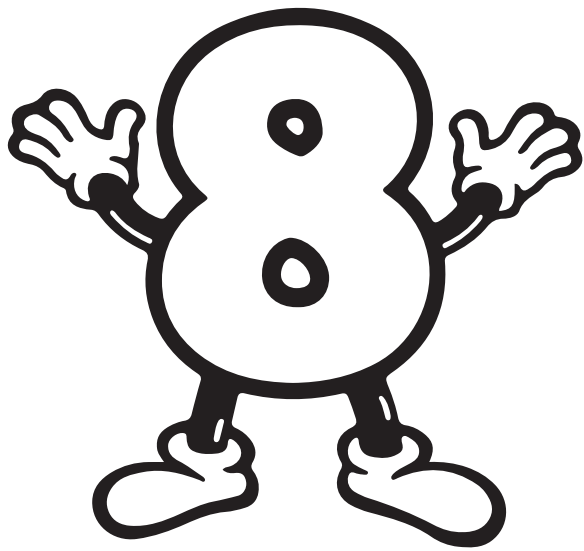

Colorea el número.

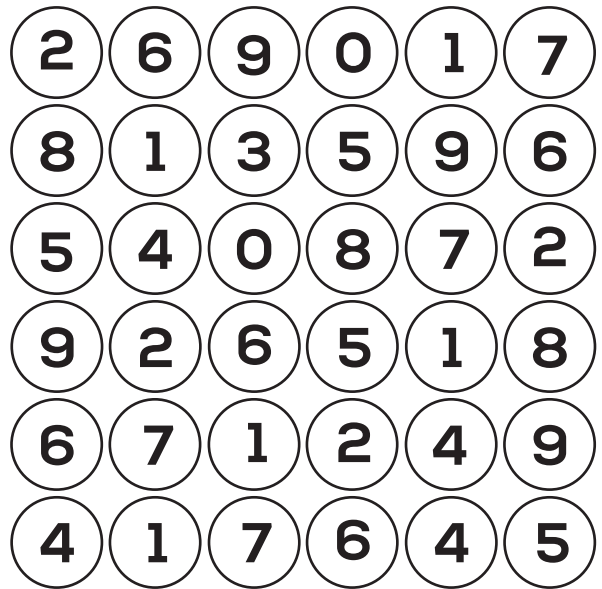

Traza y escribe.

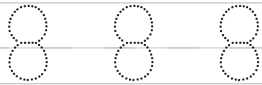

Ocho Ocho

Colorea ocho.

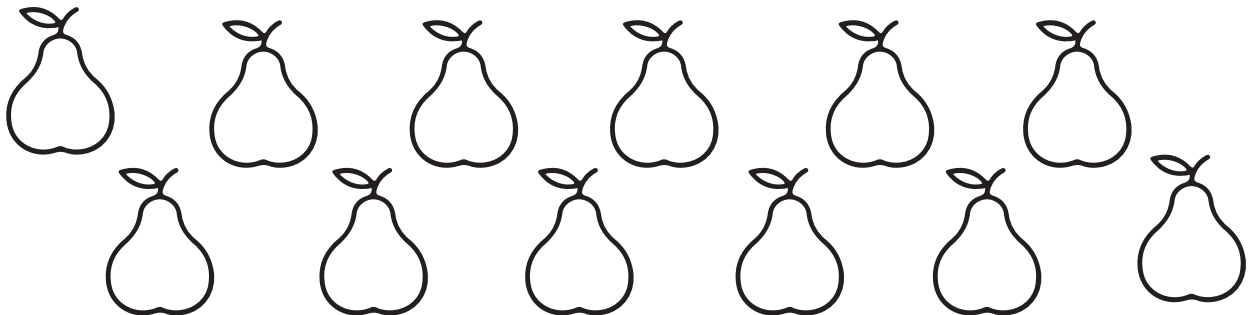

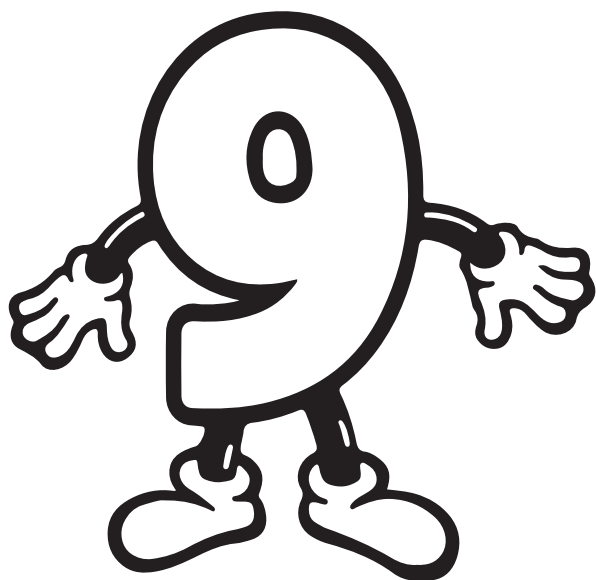

Colorea el número.

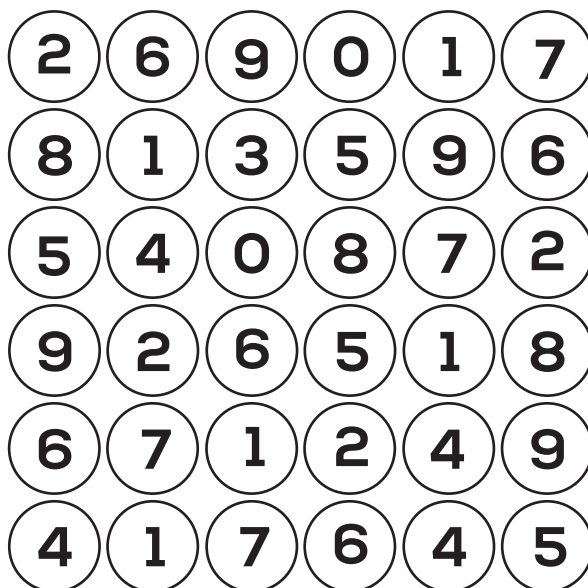

Traza y escribe.

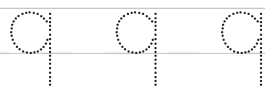

Nueve Nueve

Colorea nueve.

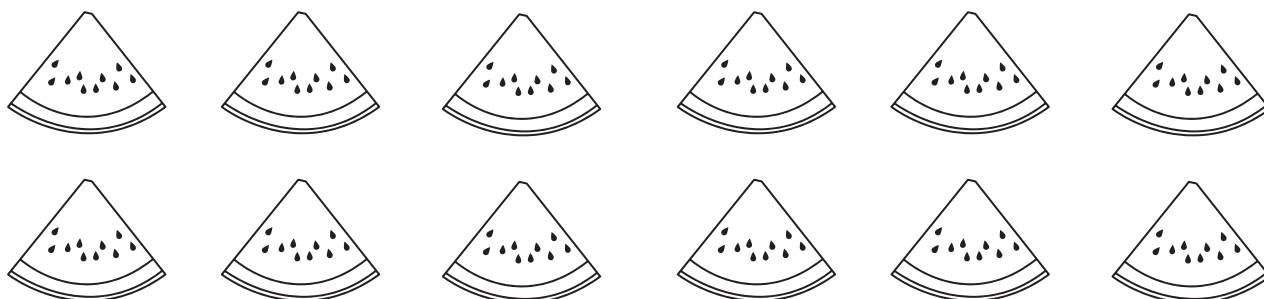

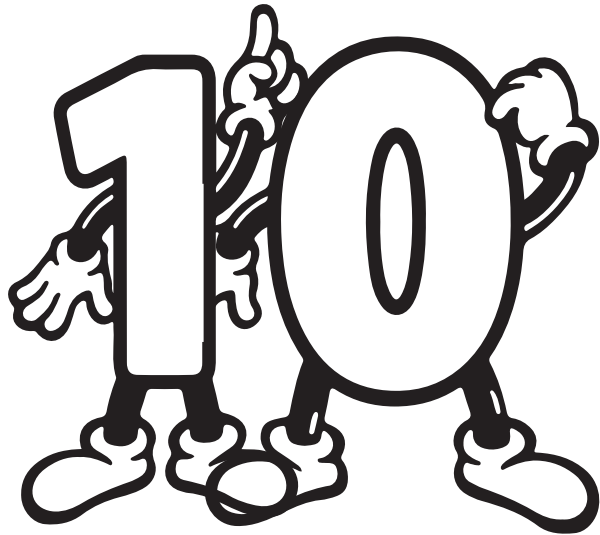

Colorea el número.

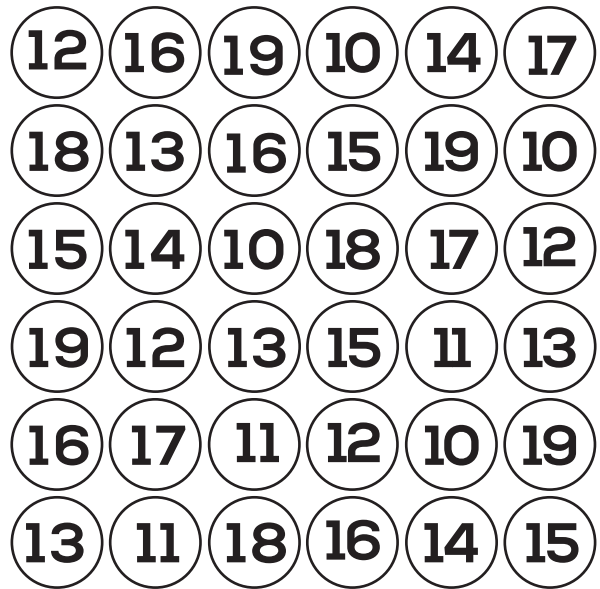

Traza y escribe.

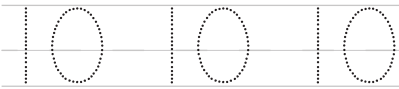

Colorea diez.

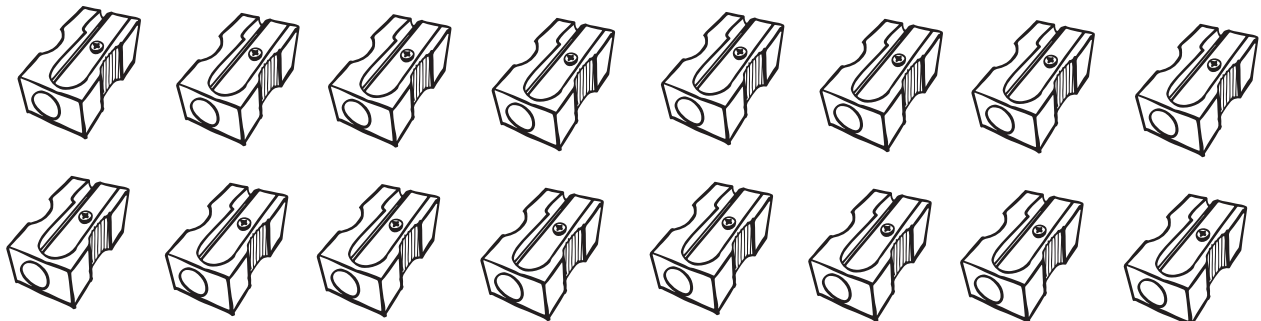

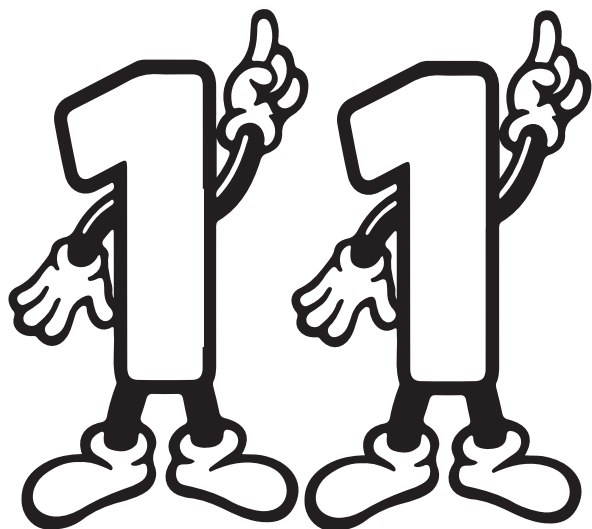

Colorea el número.

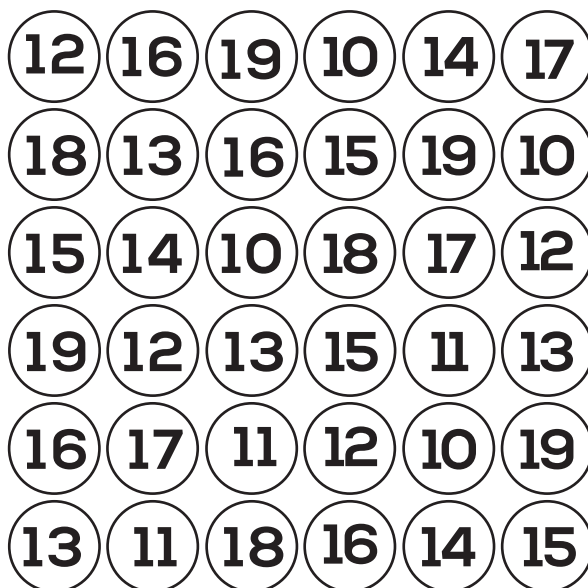

Traza y escribe.

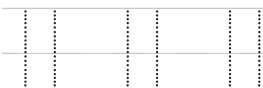
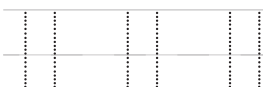

Once Once

Colorea once.

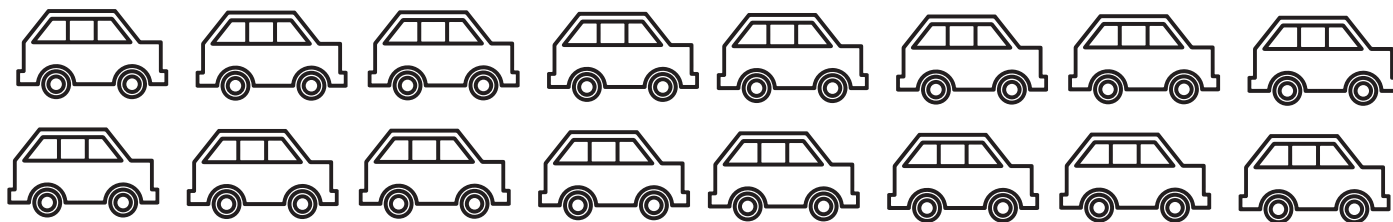



Colorea el número.

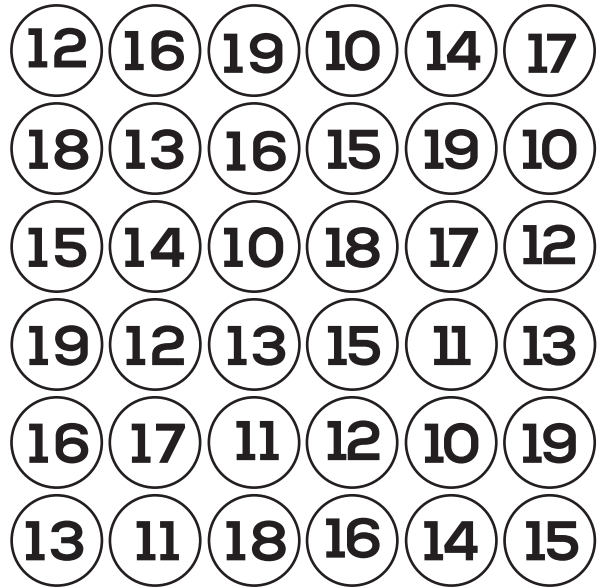

Traza y escribe.

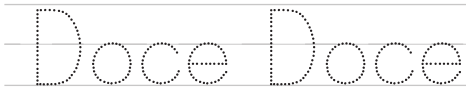
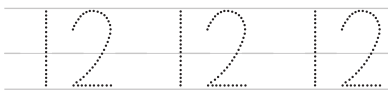

Colorea doce.

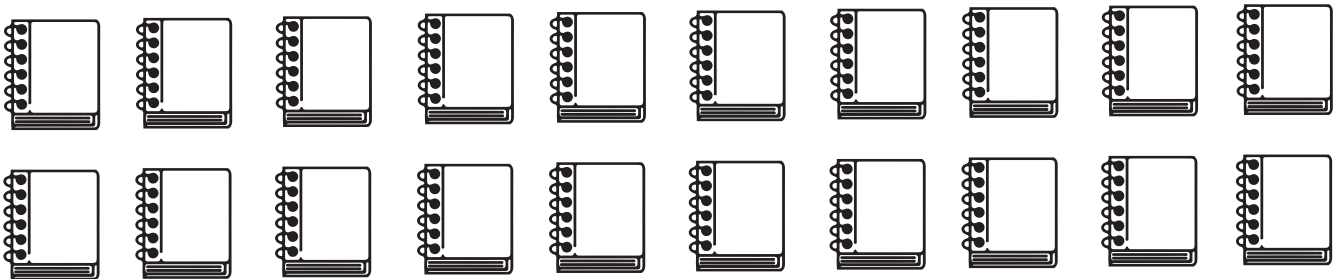



Colorea el número.

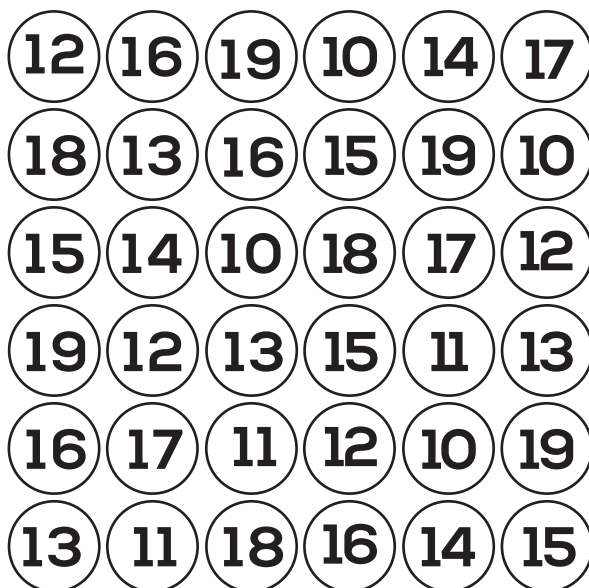

Traza y escribe.

13 13 13

13 13 13

Trece Trece

Colorea trece.

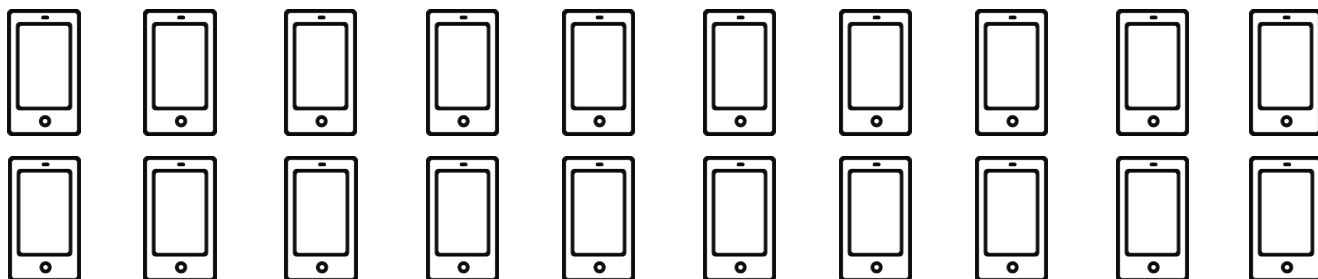

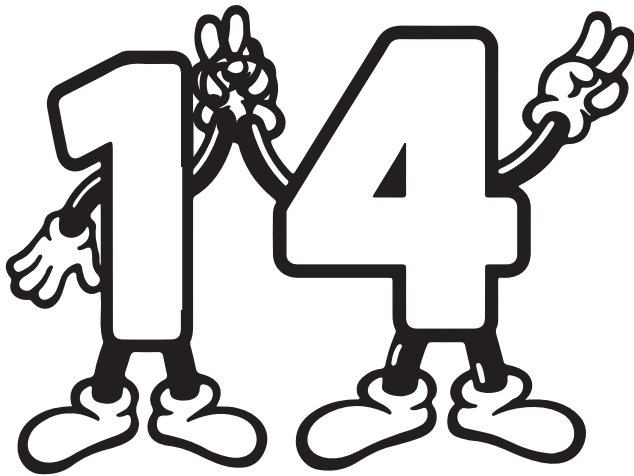

Colorea el número.

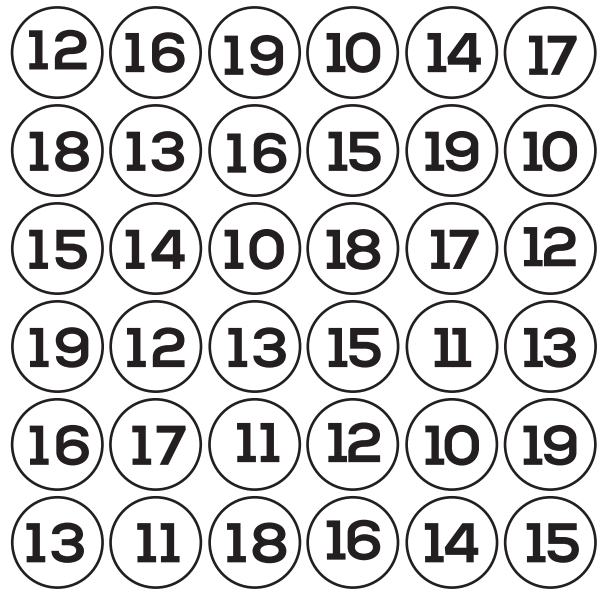

Traza y escribe.



Catorce Catorce

Colorea catorce.

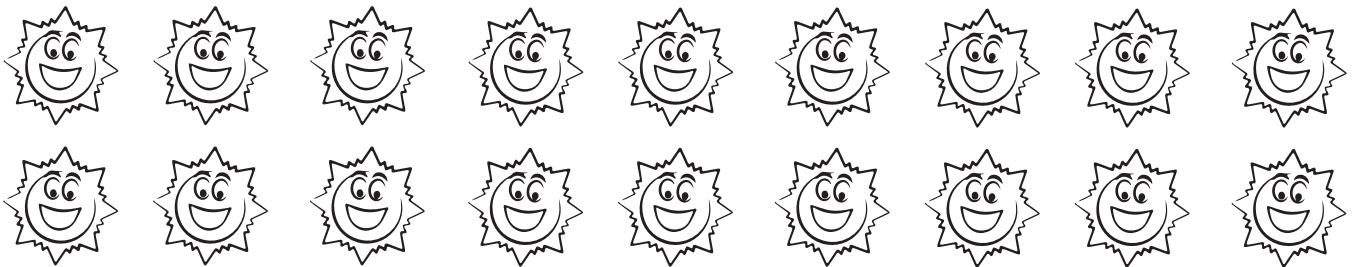



Colorea el número.

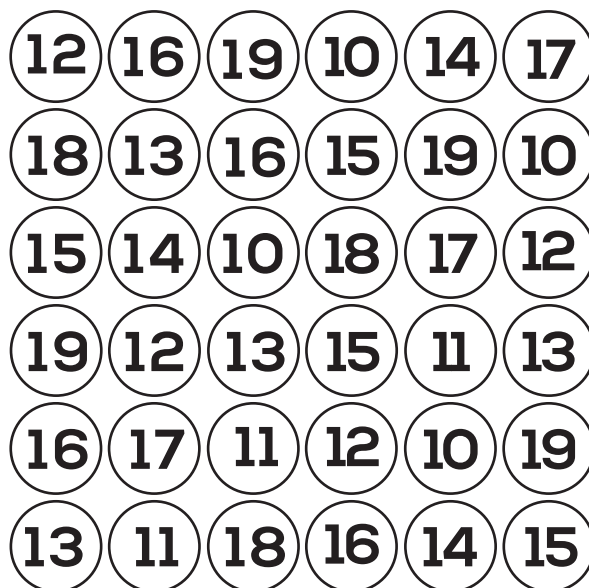

Traza y escribe.

15 15 15

15 15 15

Quince Quince

Colorea quince.





Colorea el número.

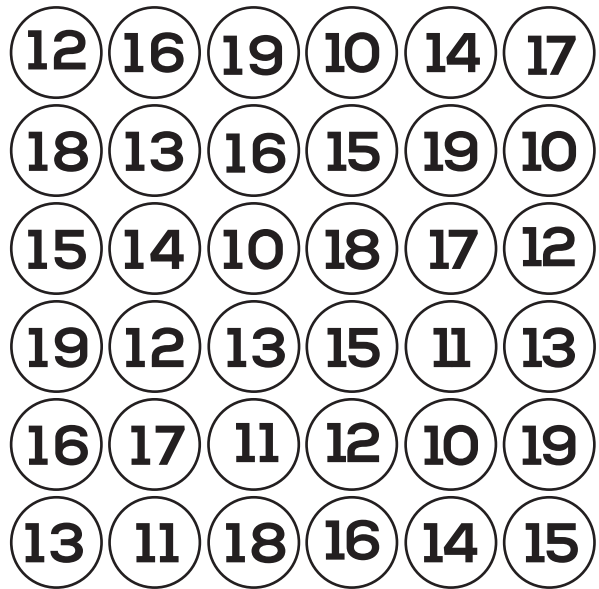

Traza y escribe.



Dieciseis Dieciseis

Colorea dieciseis.

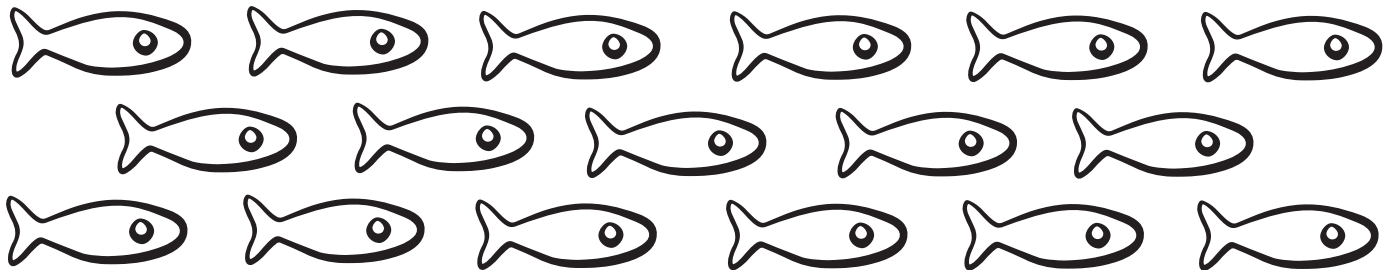



Colorea el número.

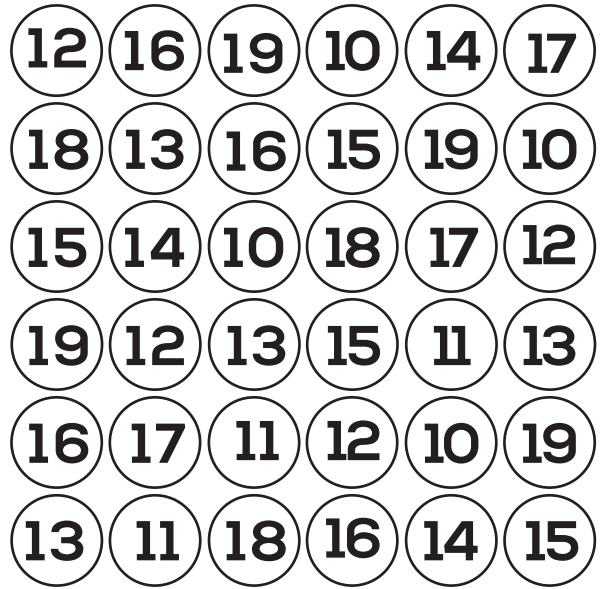

Traza y escribe.



Diecisiete Diecisiete

Colorea diecisiete.

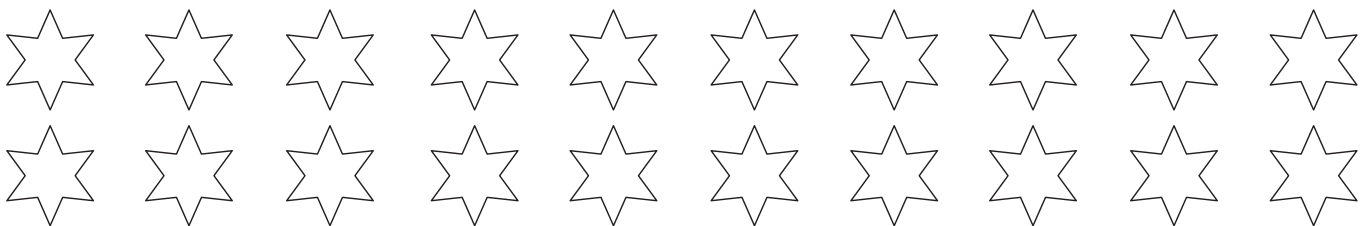

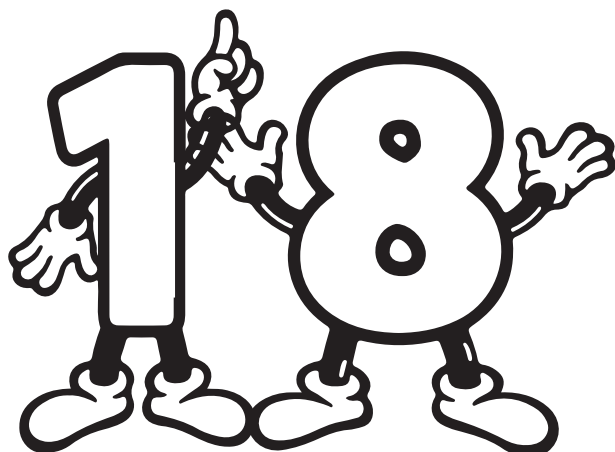

Colorea el número.

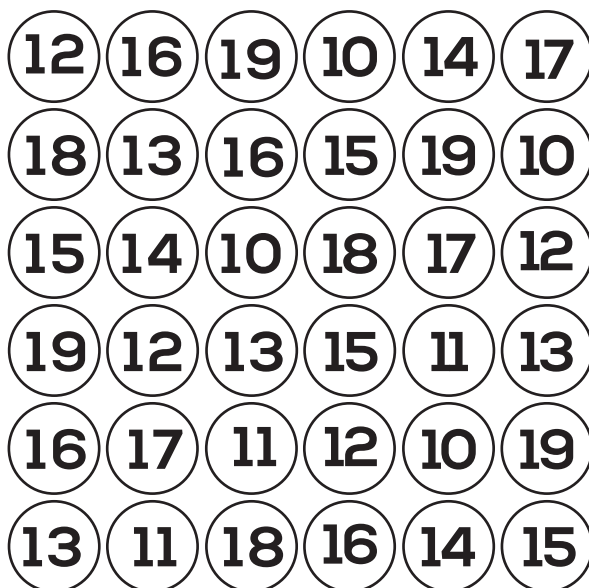

Traza y escribe.



Dieciocho Dieciocho

Colorea dieciocho.

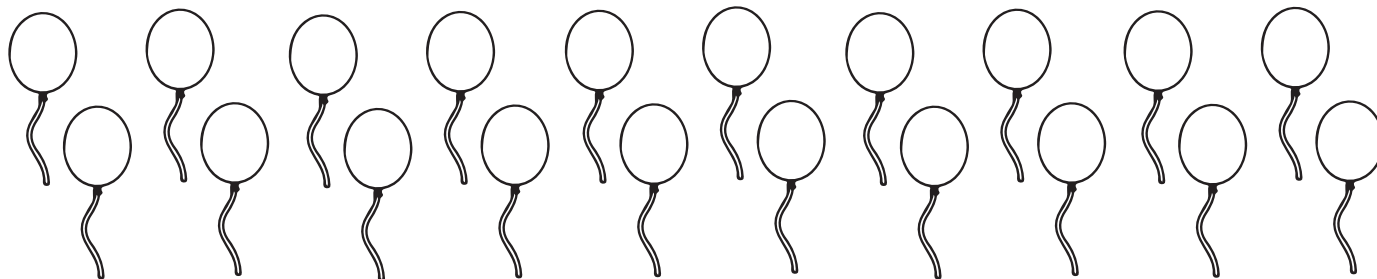



Colorea el número.

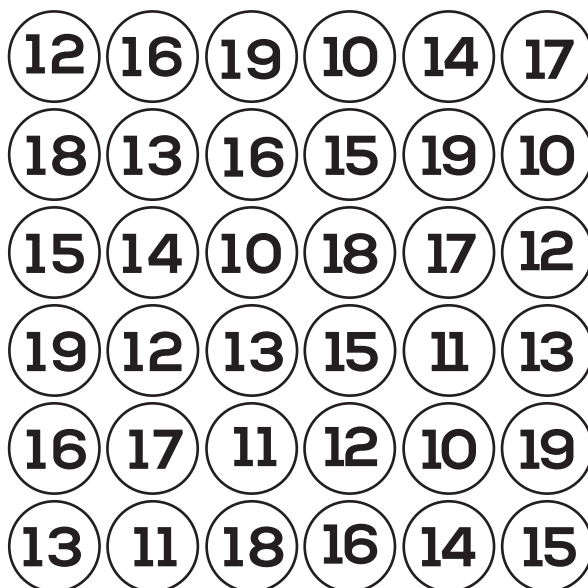

Traza y escribe.



Diecinueve Diecinueve

Colorea diecinueve.

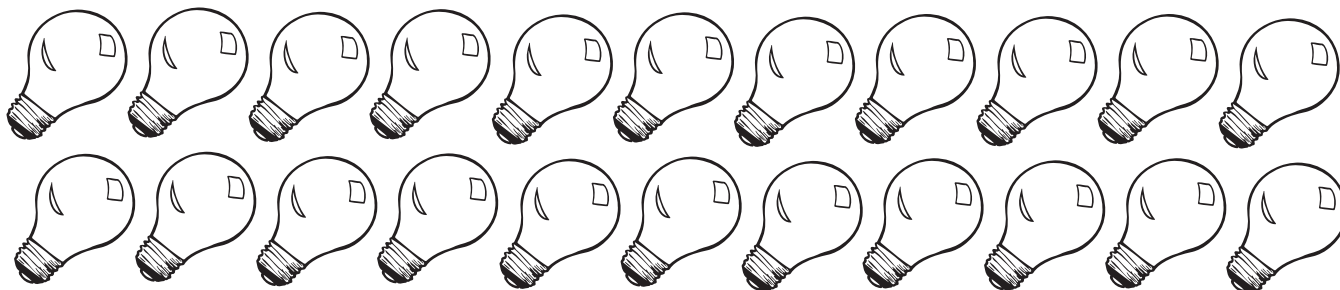



Colorea el número.

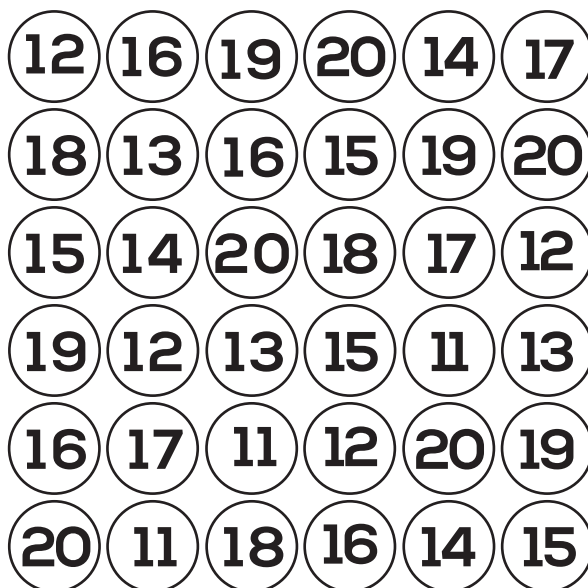

Traza y escribe.

20 20 20

20 20 20

Veinte Veinte

Colorea veinte.

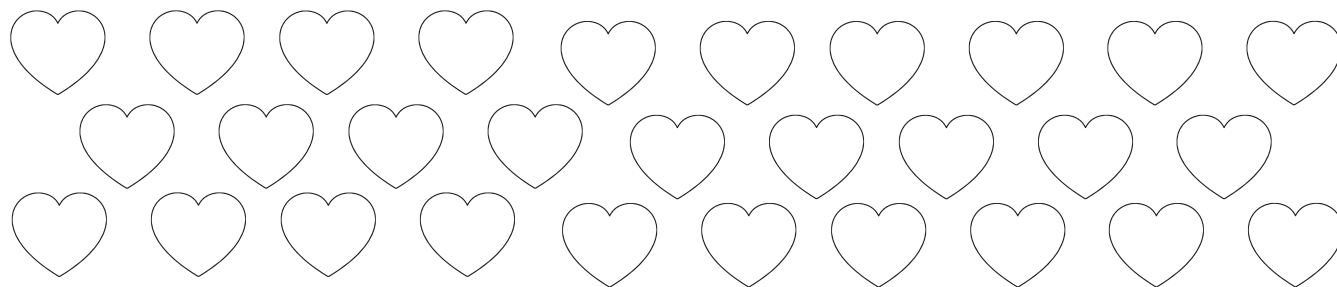

Números del 1 al 10

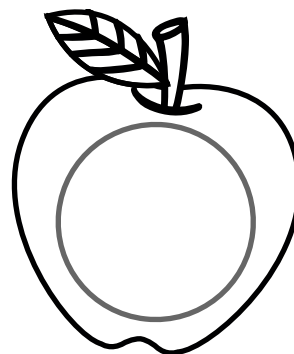
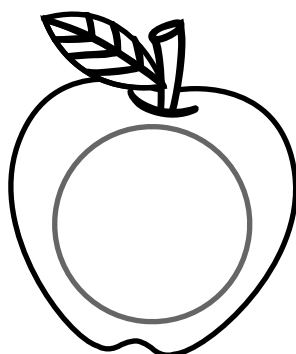
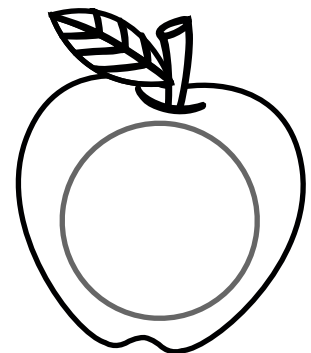
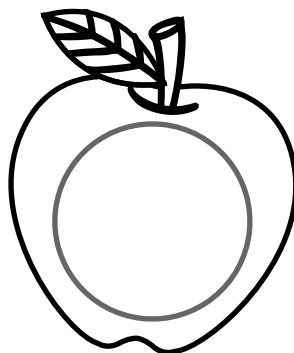
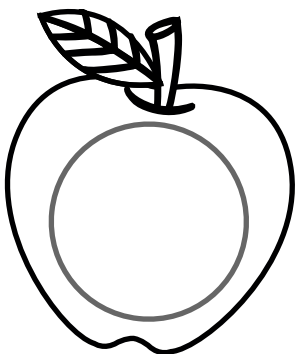
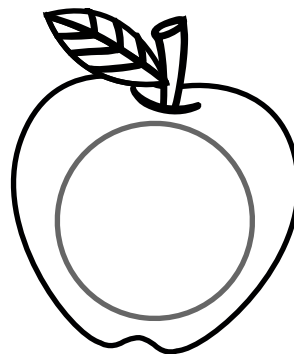
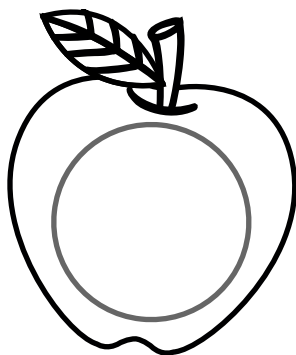
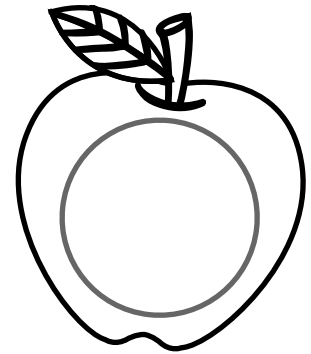
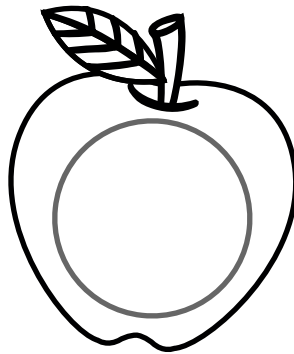
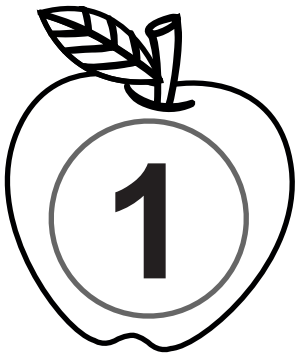

Números del 1 al 20



Números del 1 al 25

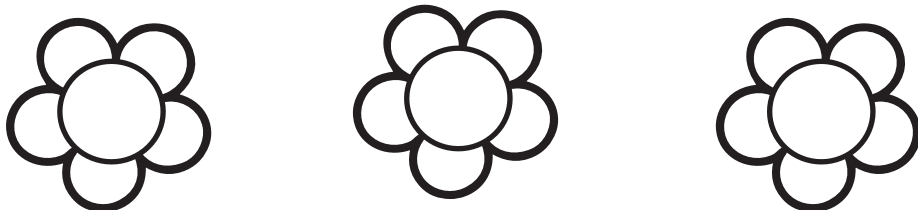
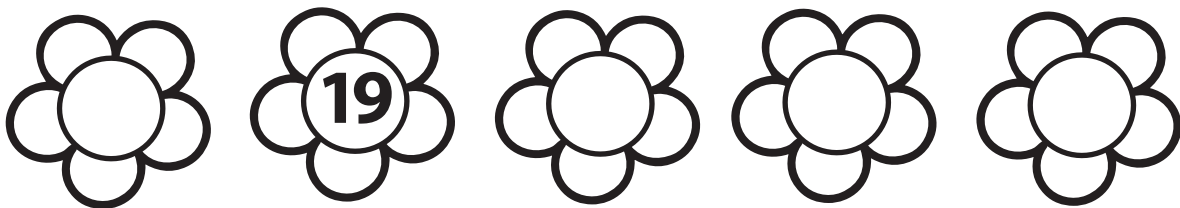
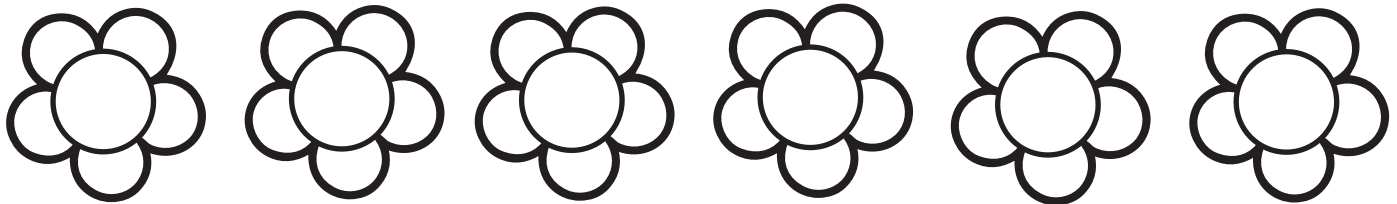
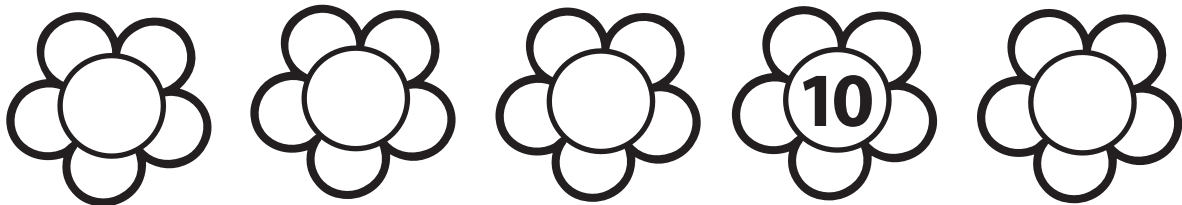
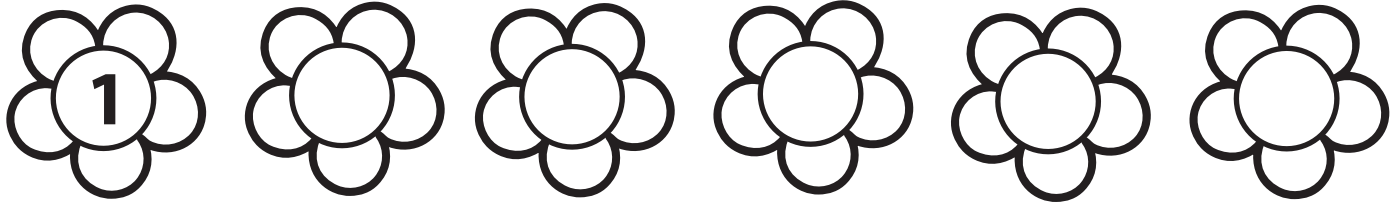

Números del 1 al 30

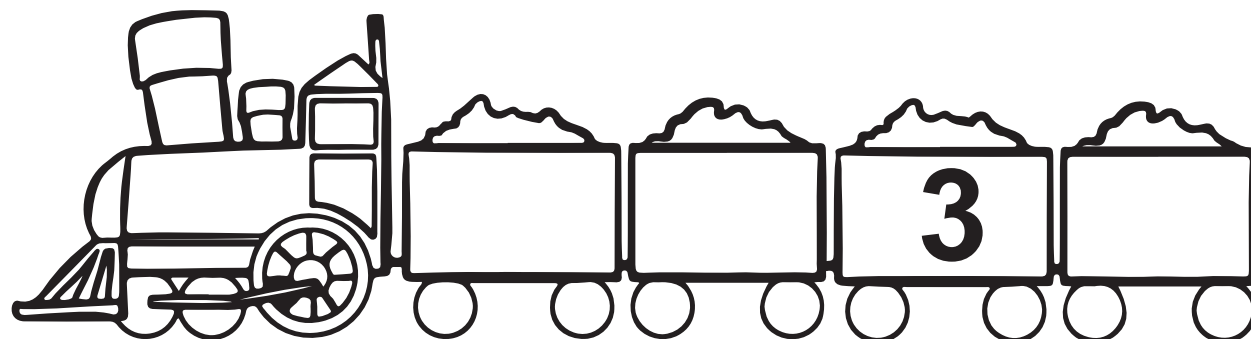

Números del 1 al 40

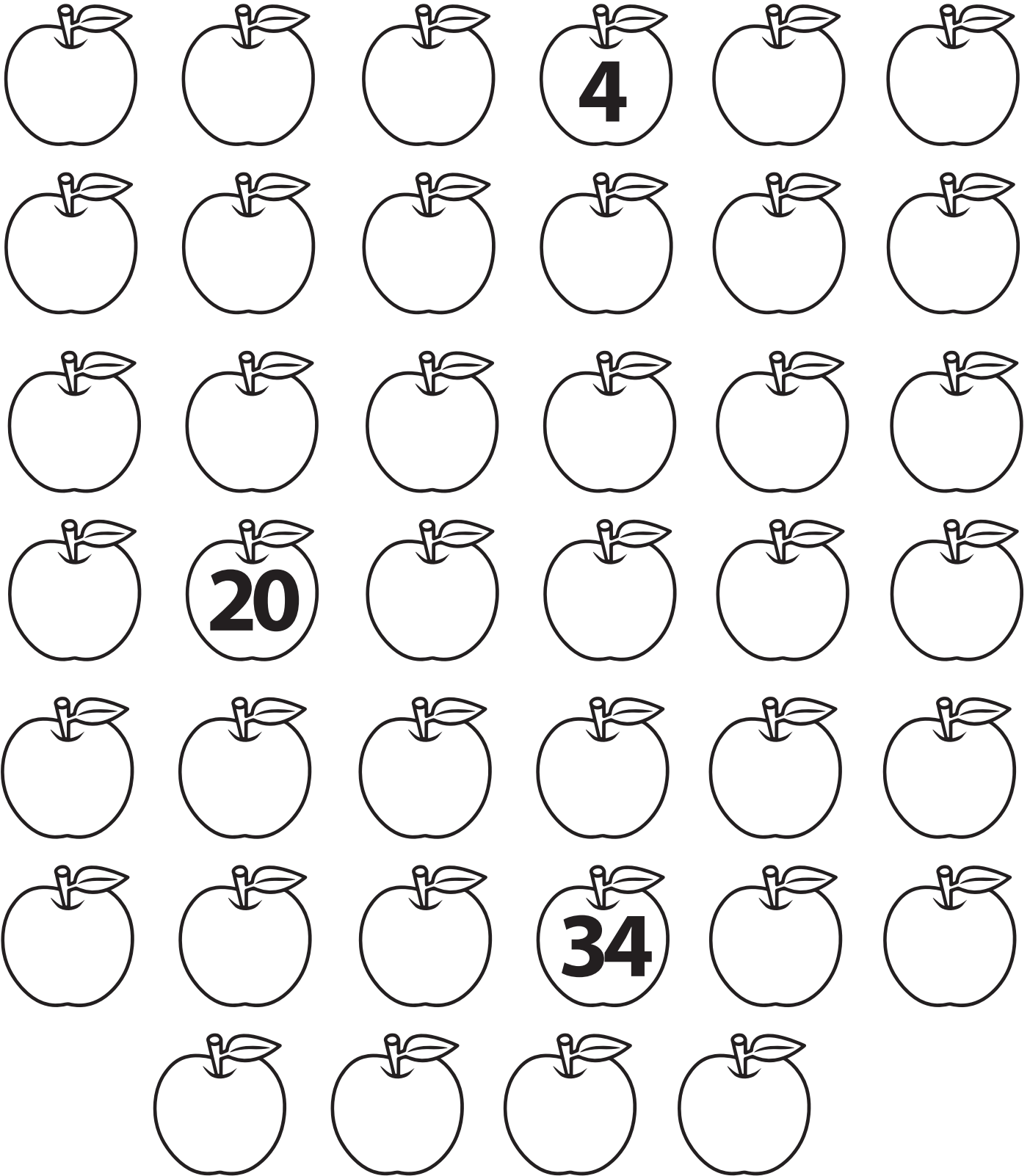

Números del 1 al 50

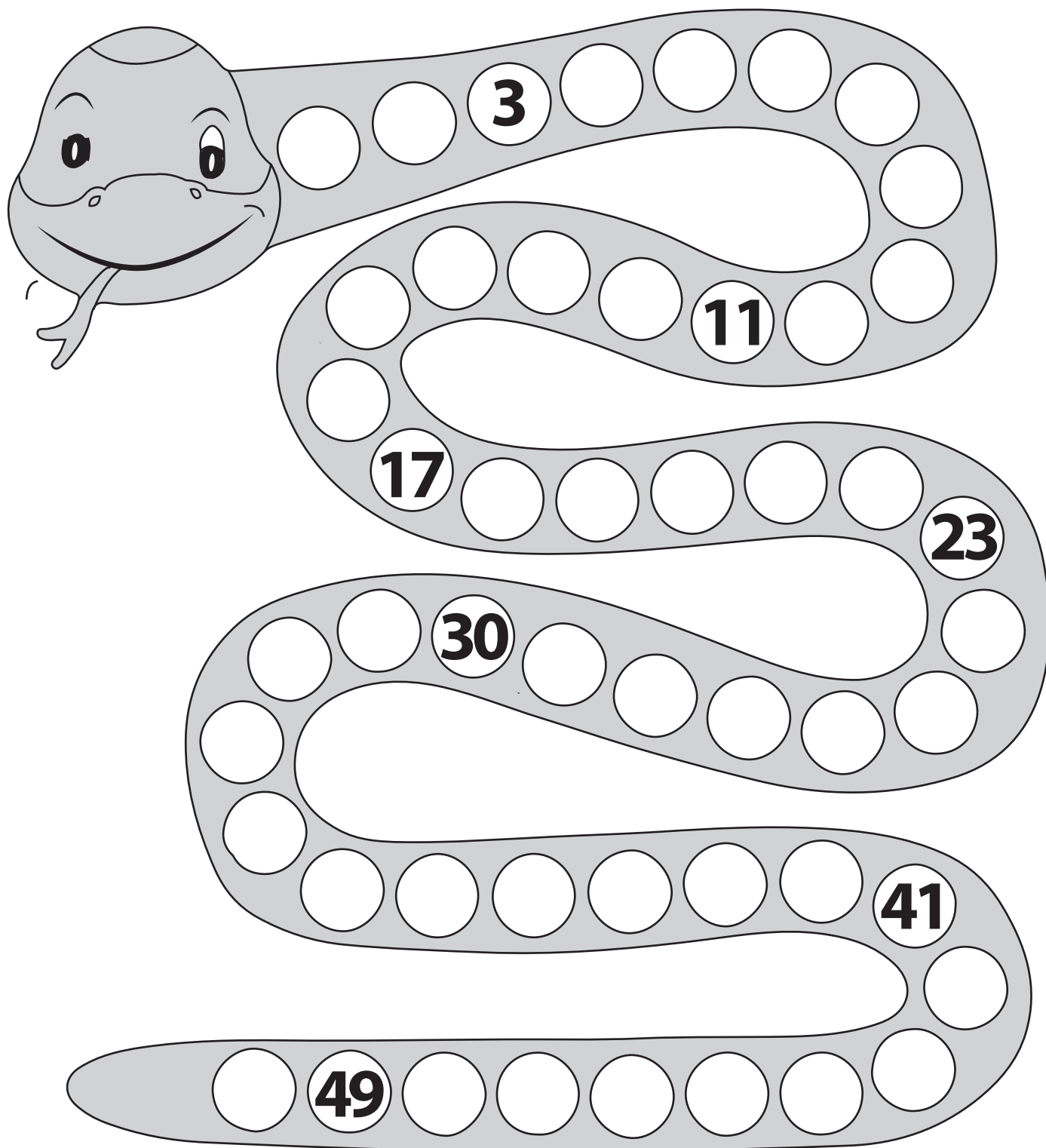

Números del 1 al 50

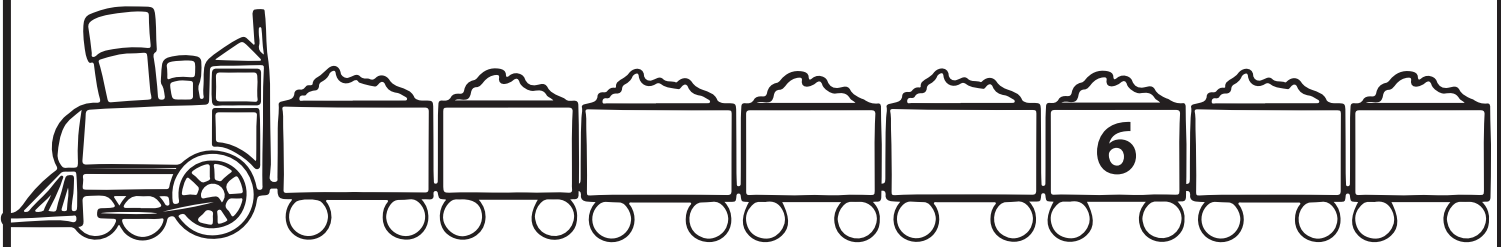

Números del 1 al 100



				5					
							18		
		23							
						37			
41									
				55					
									70
					76				
	81								
							98		

Números del 1 al 100



									10
									20
									30
									40
									50
									60
									70
									80
									90
									100



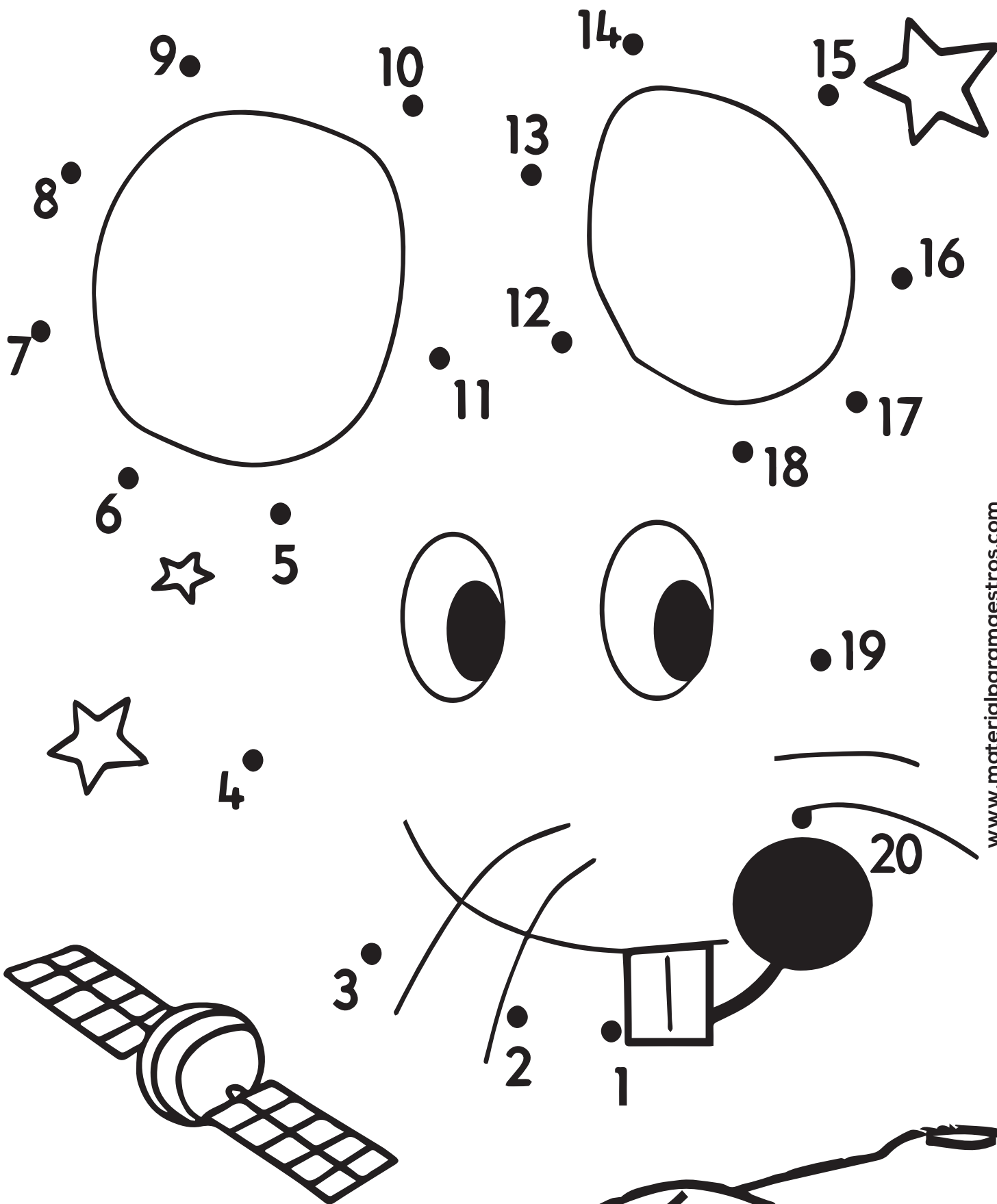

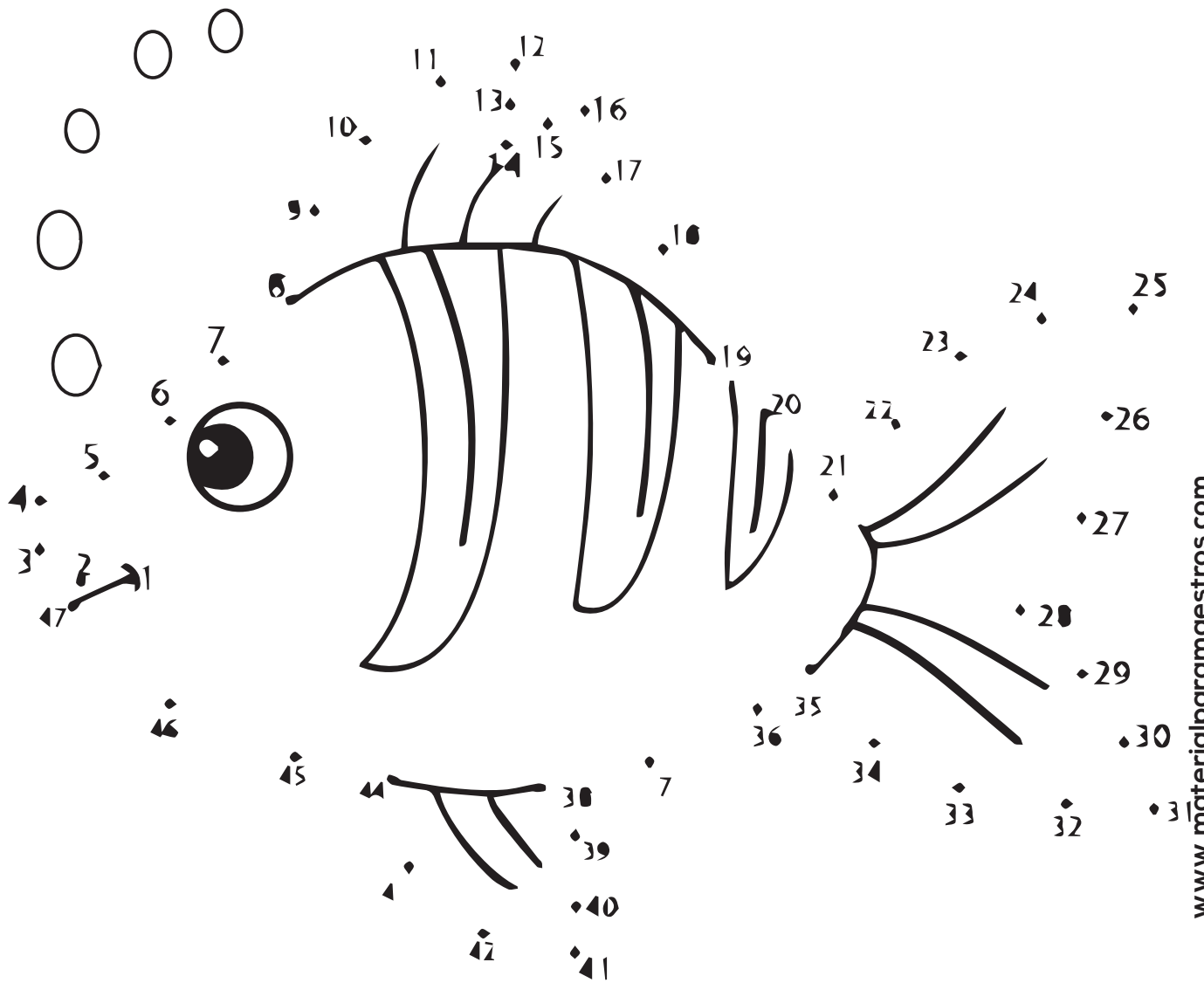

www.materialparamaestros.com



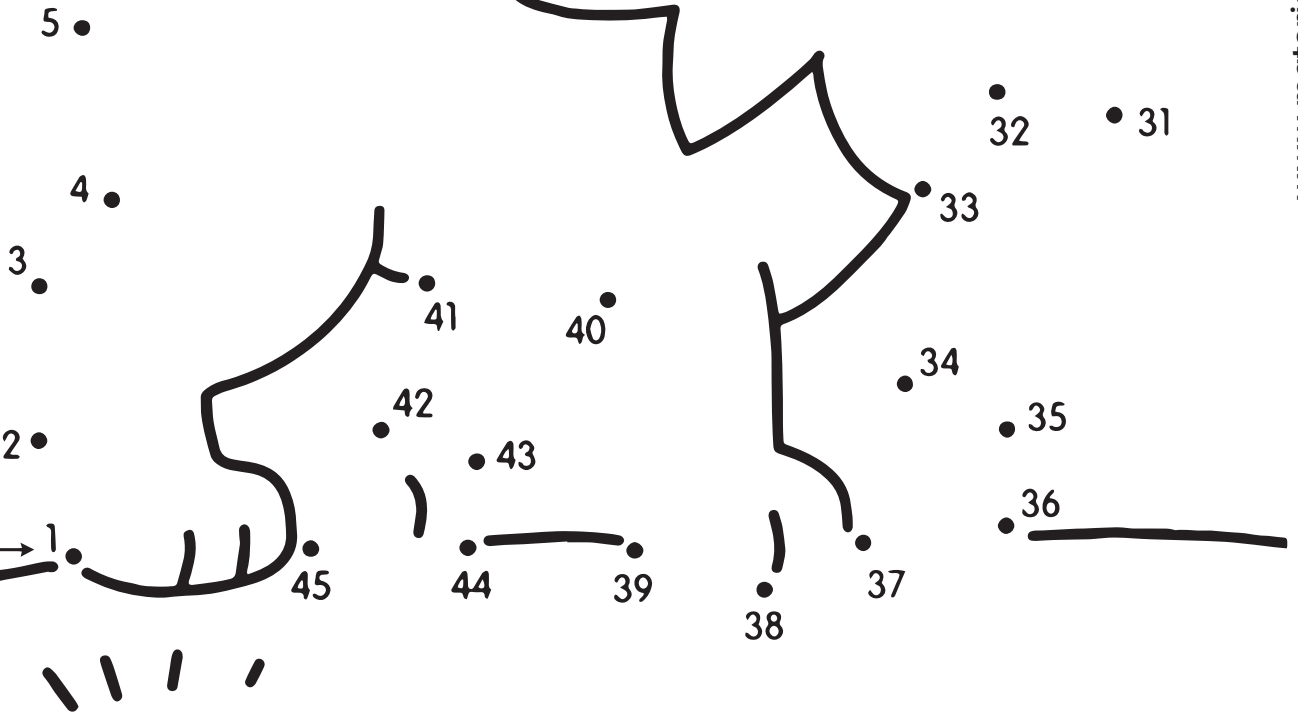
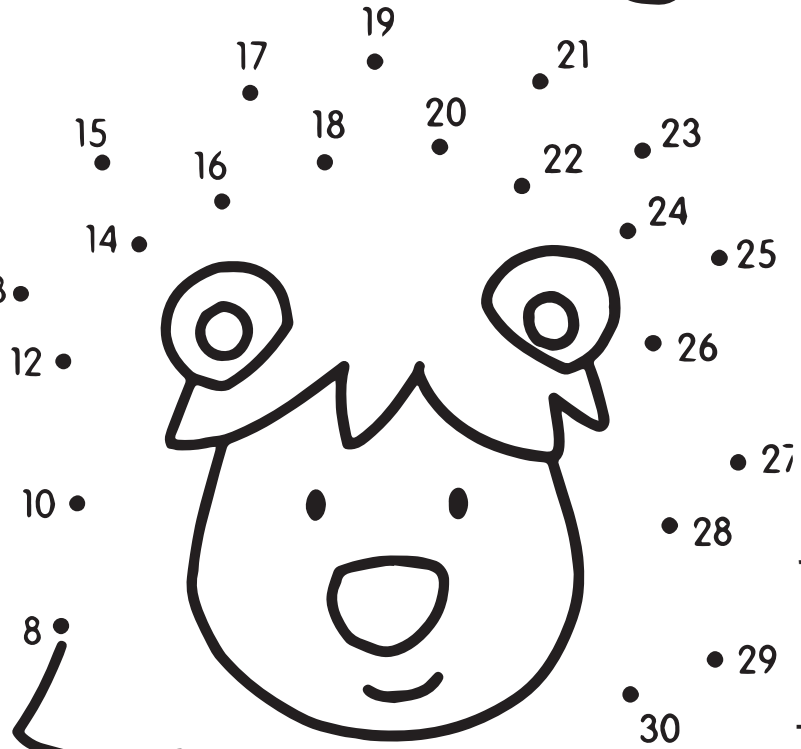
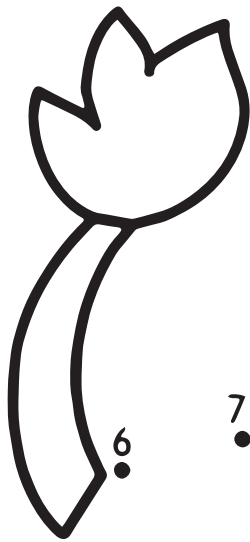
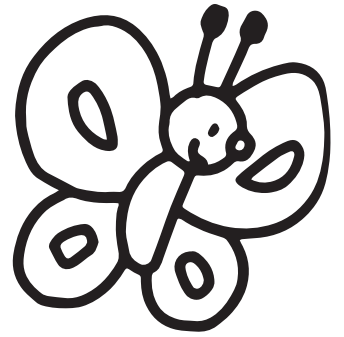
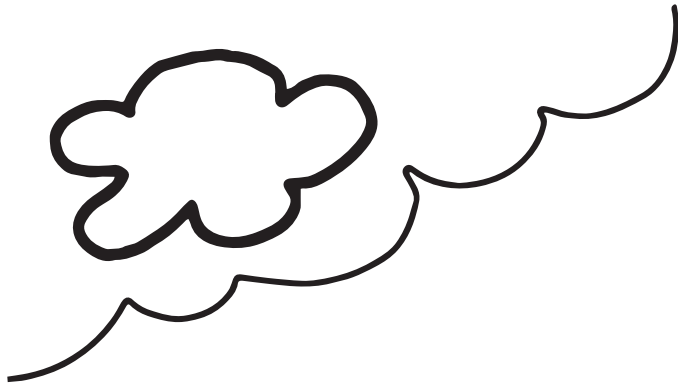

INICIO →

1

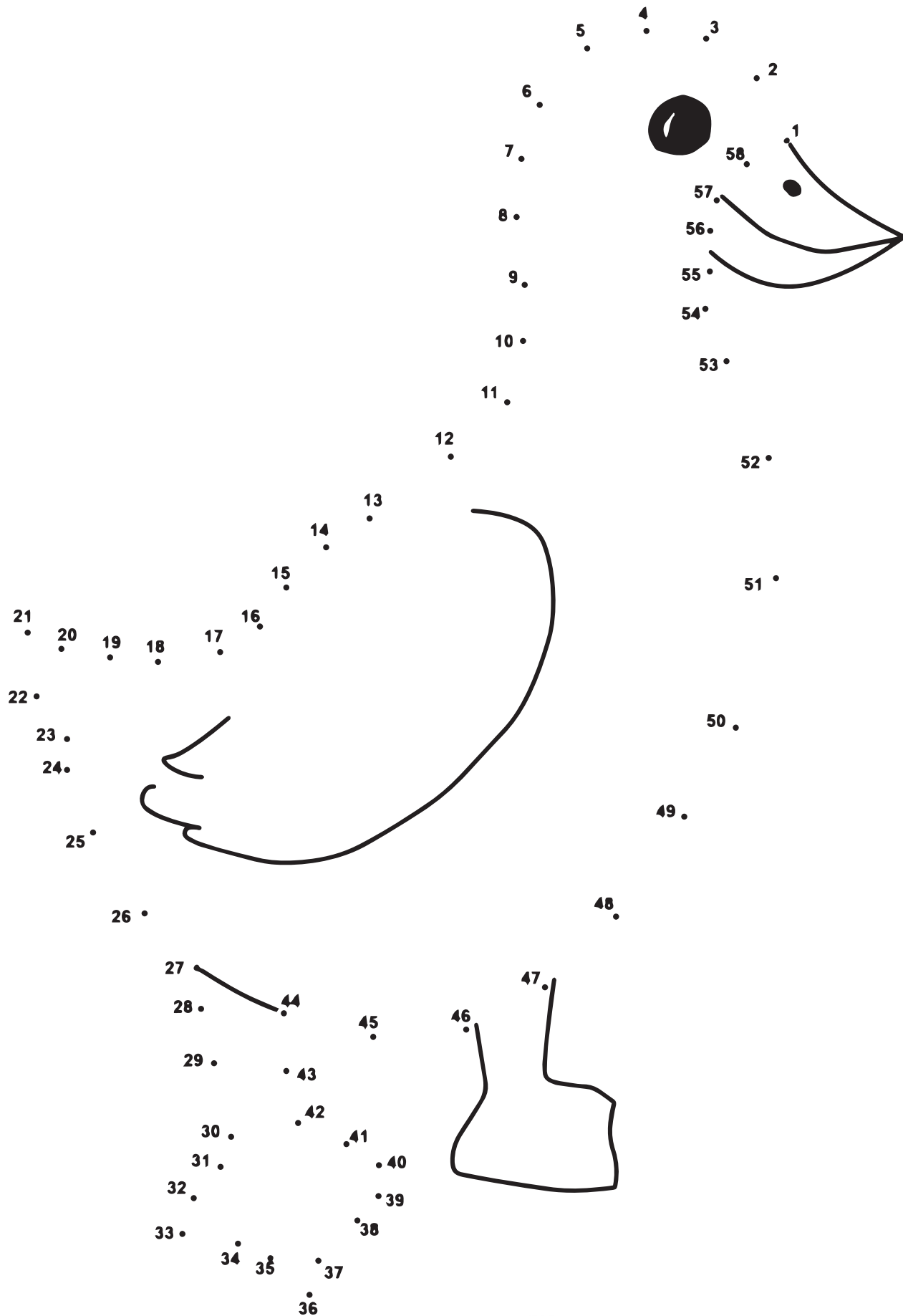

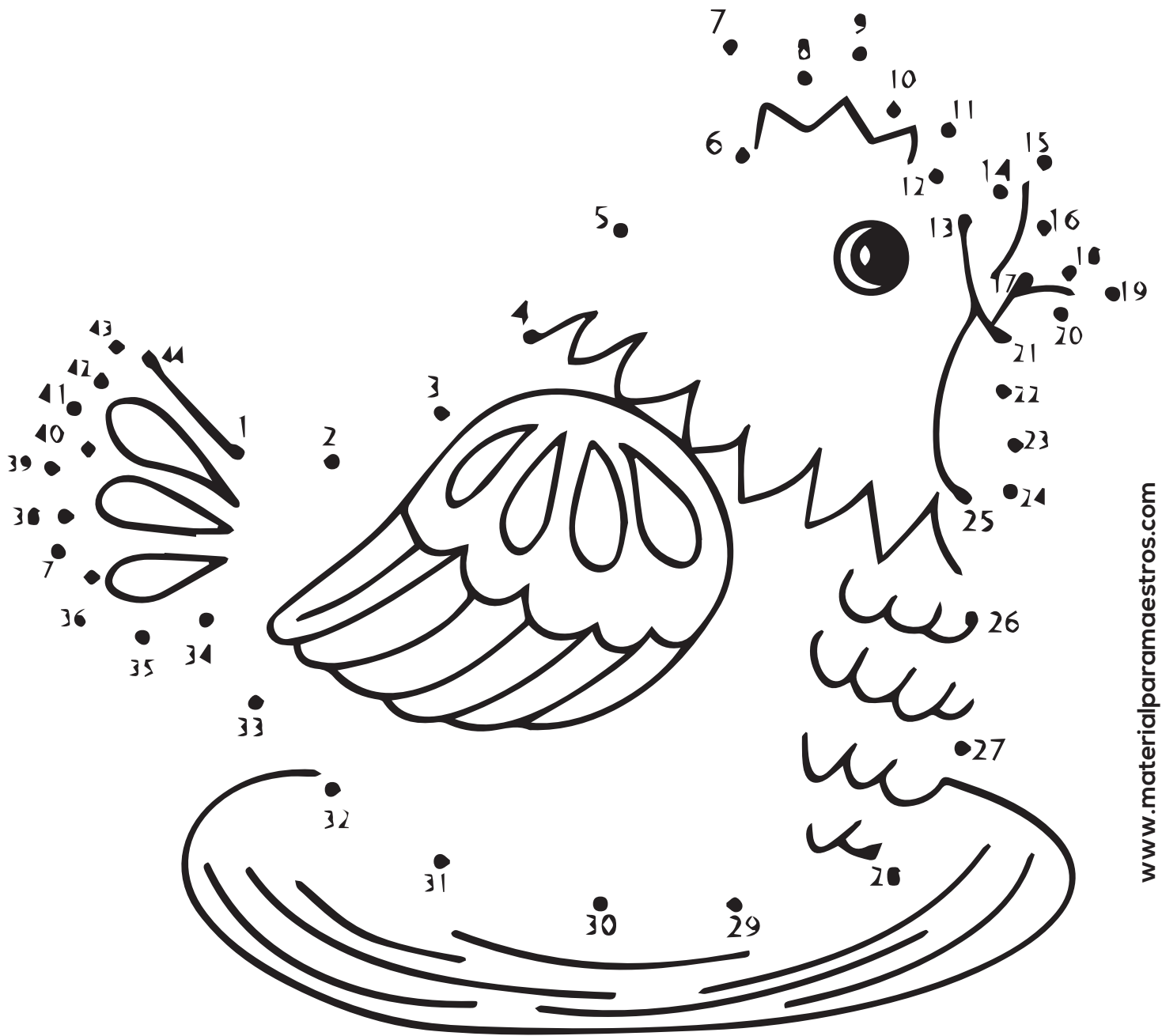

www.materialparamaestros.com

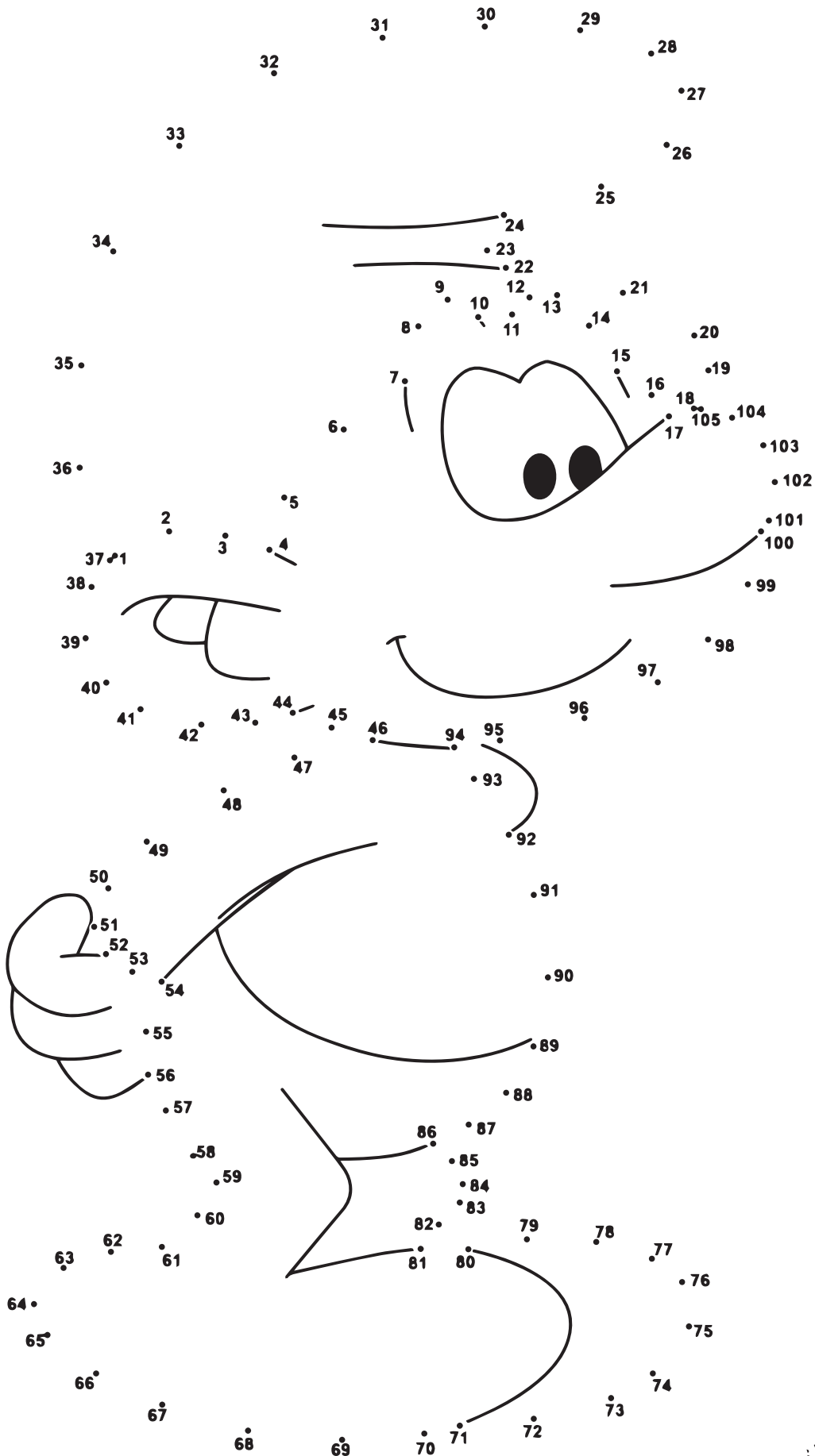

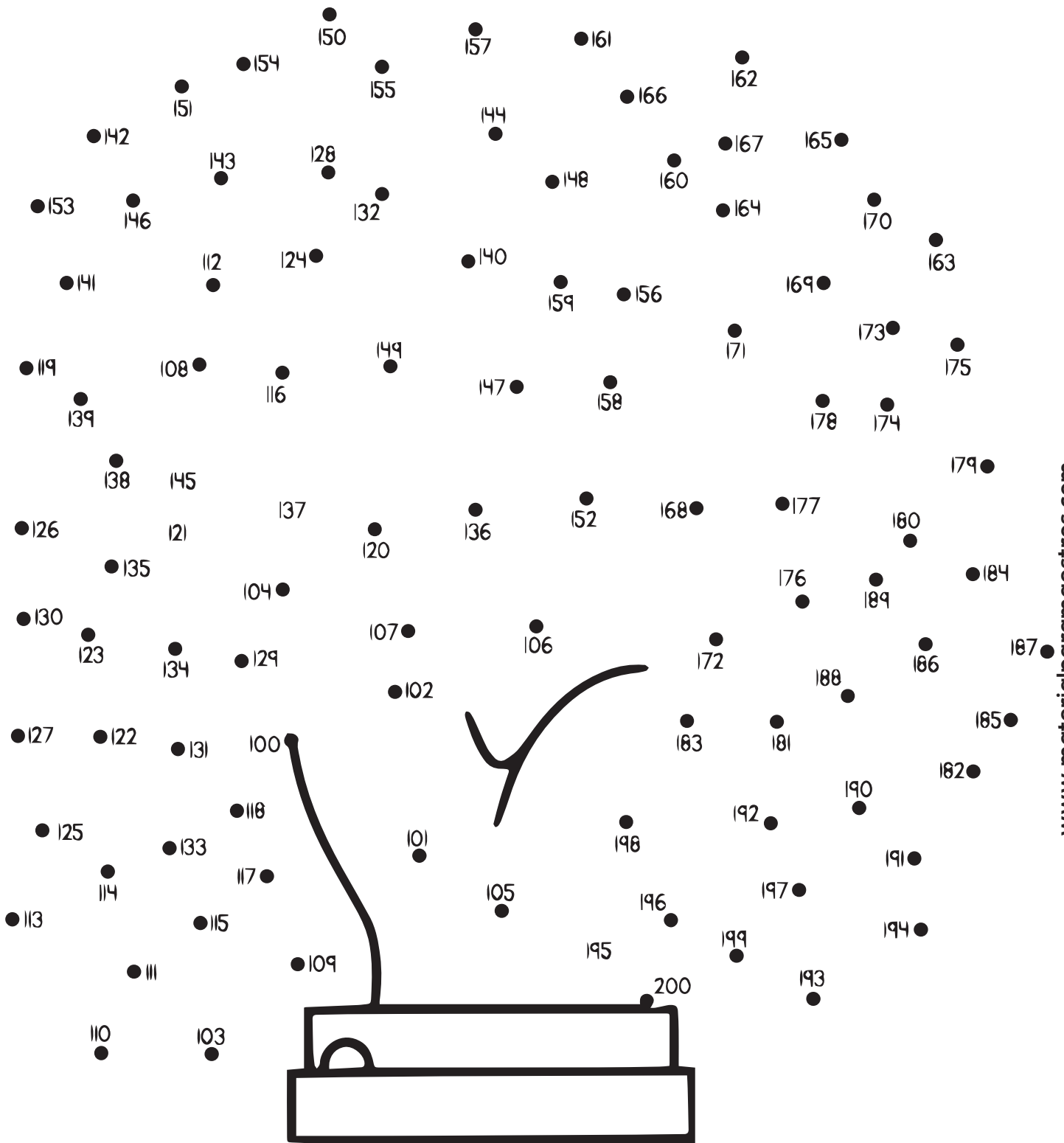

Uno

1 1 1 1 1 1 1 1 1 1 1 1 1 1 1 1 1

1 1 1 1 1 1 1 1 1 1 1 1 1 1 1 1 1

1 1 1 1 1 1 1 1 1 1 1 1 1 1 1 1 1

1 1 1 1 1 1 1 1 1 1 1 1 1 1 1 1 1

1 1 1 1 1 1 1 1 1 1 1 1 1 1 1 1 1

1 1 1 1 1 1 1 1 1 1 1 1 1 1 1 1 1

1 1 1 1 1 1 1 1 1 1 1 1 1 1 1 1 1

Dos

2 2 2 2 2 2 2 2 2 2 2 2 2

2 2 2 2 2 2 2 2 2 2 2 2 2

2

2

2

2

2

Tres

3 3 3 3 3 3 3 3 3 3 3 3 3

3 3 3 3 3 3 3 3 3 3 3 3 3

3

3

3

3

3

Cuatro

4 4 4 4 4 4 4 4 4 4 4 4 4

4 4 4 4 4 4 4 4 4 4 4 4 4

4

4

4

4

4

Cinco

5 5 5 5 5 5 5 5 5 5 5 5 5

5 5 5 5 5 5 5 5 5 5 5 5 5

5

5

5

5

5

Seis

6 6 6 6 6 6 6 6 6 6 6 6 6

6 6 6 6 6 6 6 6 6 6 6 6 6

6

6

6

6

6

Siete

7 7 7 7 7 7 7 7 7 7 7 7 7

7 7 7 7 7 7 7 7 7 7 7 7 7

7

7

7

7

7

Ocho

8 8 8 8 8 8 8 8 8 8 8 8 8

8 8 8 8 8 8 8 8 8 8 8 8

8

8

8

8

8

Nueve

9 9 9 9 9 9 9 9 9 9 9 9

9 9 9 9 9 9 9 9 9 9 9 9

9

9

9

9

9

Cero

0 0 0 0 0 0 0 0 0 0 0 0 0

0 0 0 0 0 0 0 0 0 0 0

0

0

0

0

0

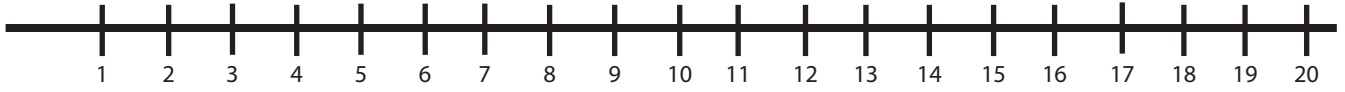
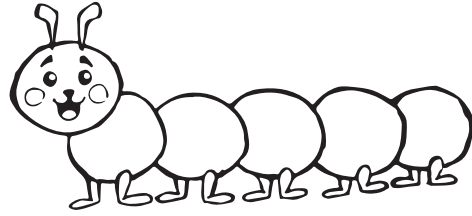

1



7

15

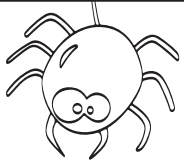

18



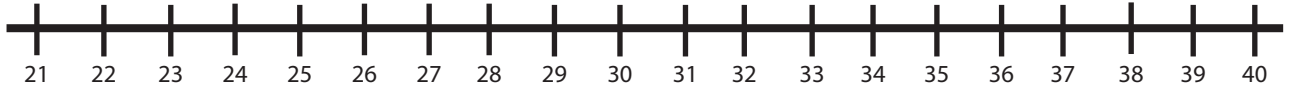
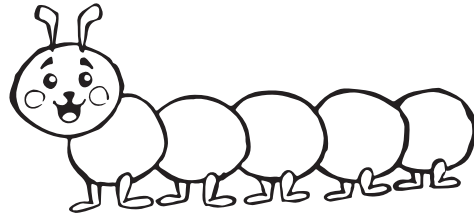

22

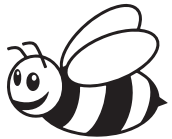

28

35

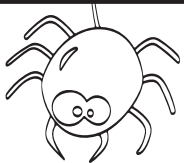

39



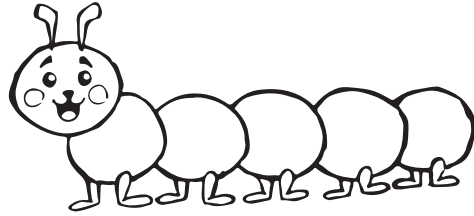

42



48

55

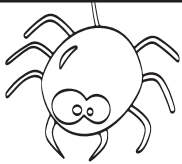

59



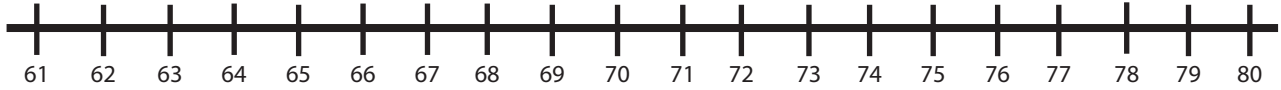
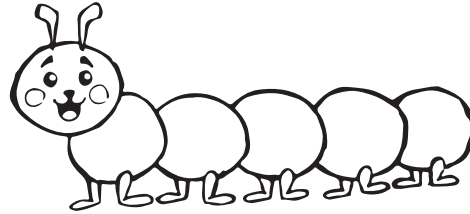

	62			
--	-----------	--	--	--



		68		
--	--	-----------	--	--

				75	
--	--	--	--	-----------	--

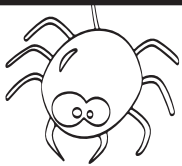

		79	
--	--	-----------	--



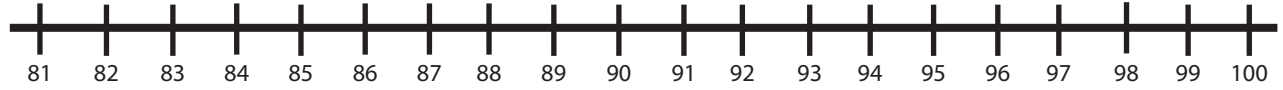
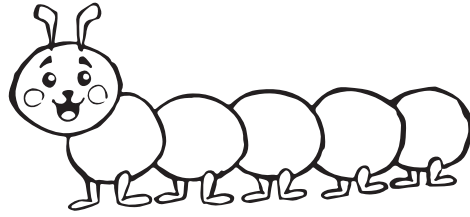

82



88

95

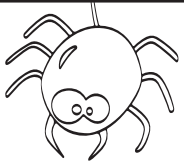

99



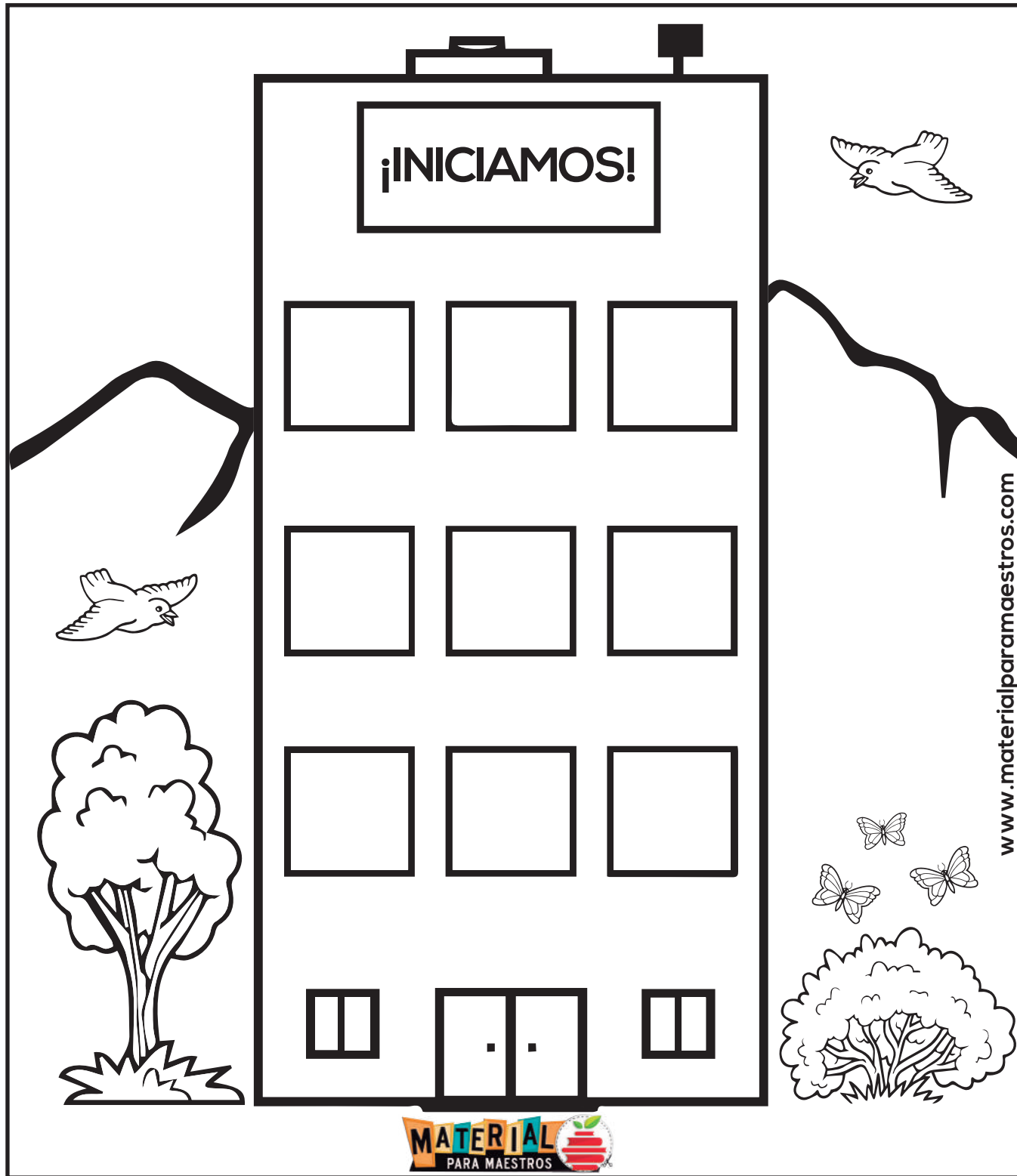

¡INICIAMOS!

Recorta y pega donde corresponde.

1	2	3
4	5	6
7	8	9

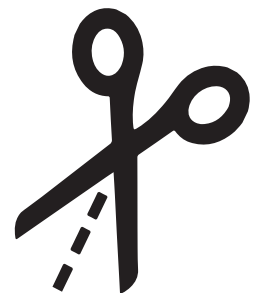
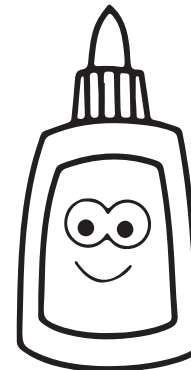

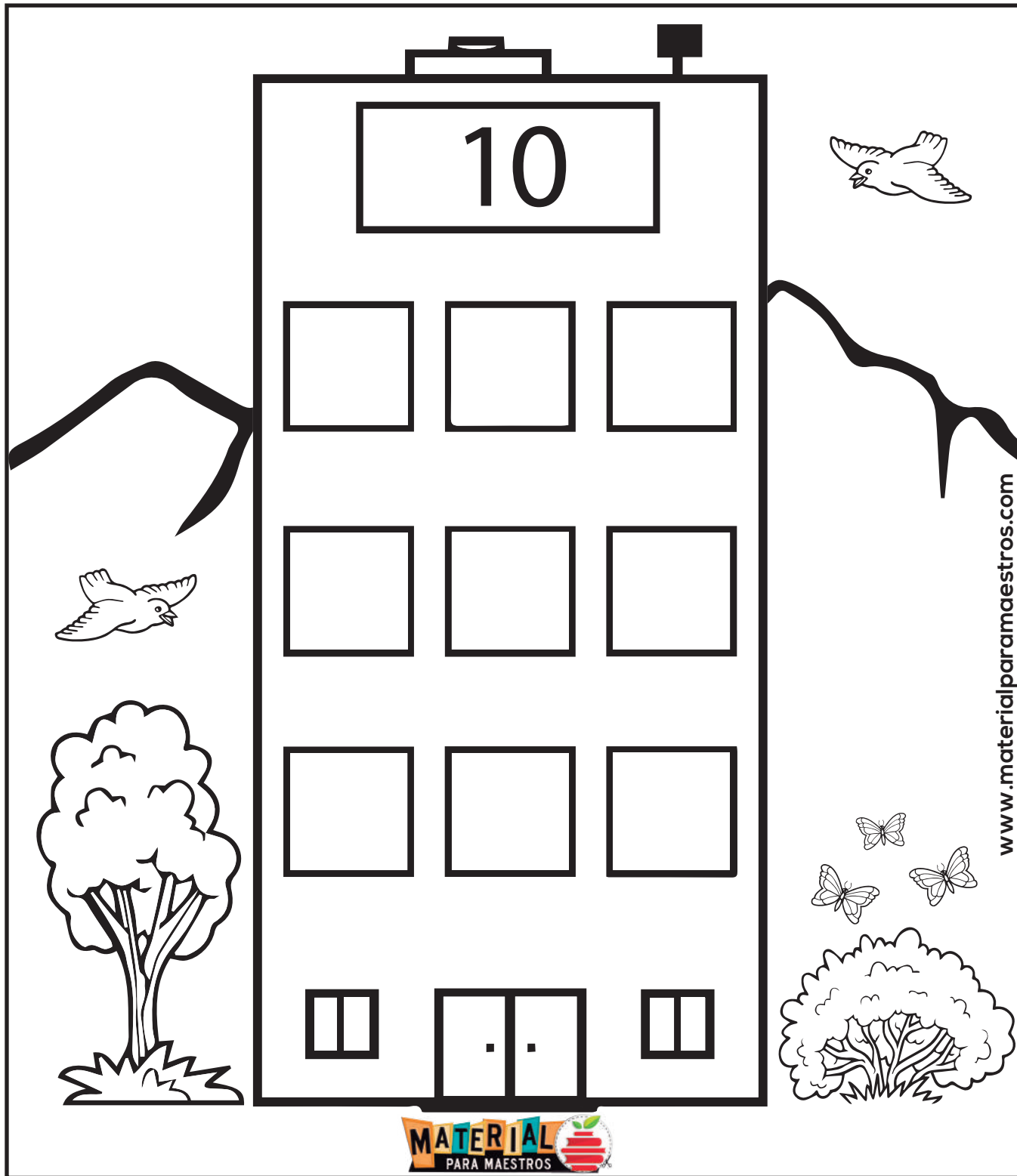

10

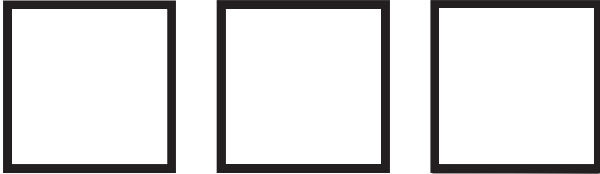
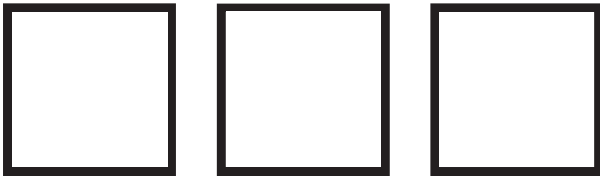
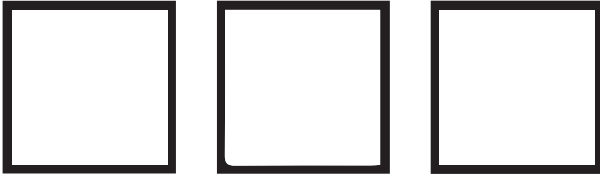

www.materialparamaestros.com

Recorta y pega donde corresponde.

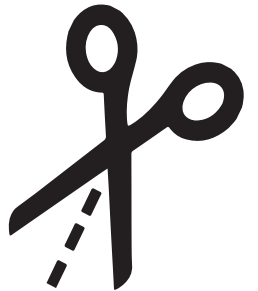
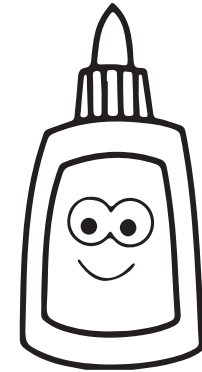
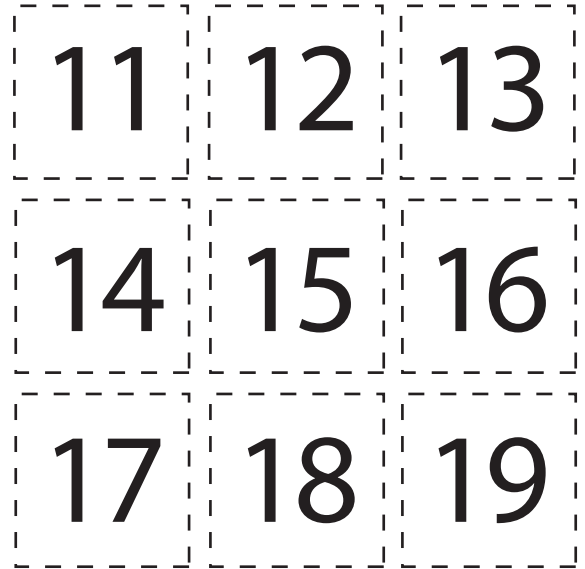

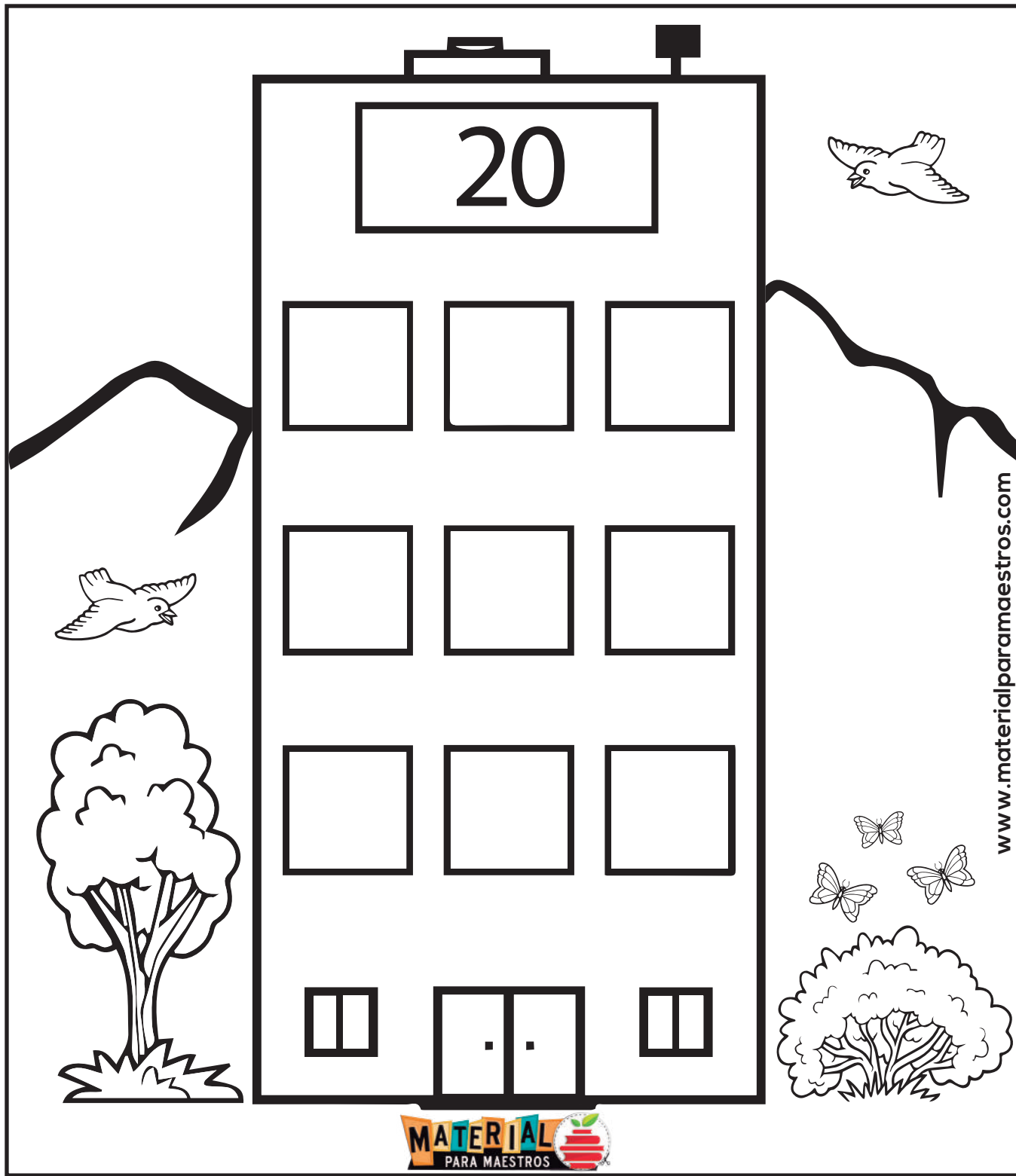

Recorta y pega donde corresponde.

21 22 23

24 25 26

27 28 29

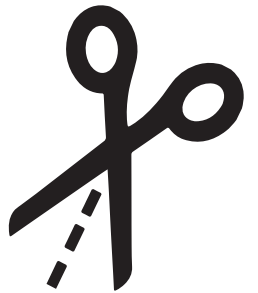
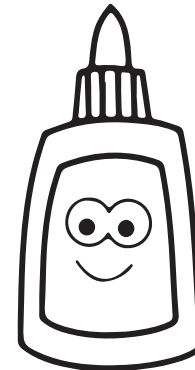

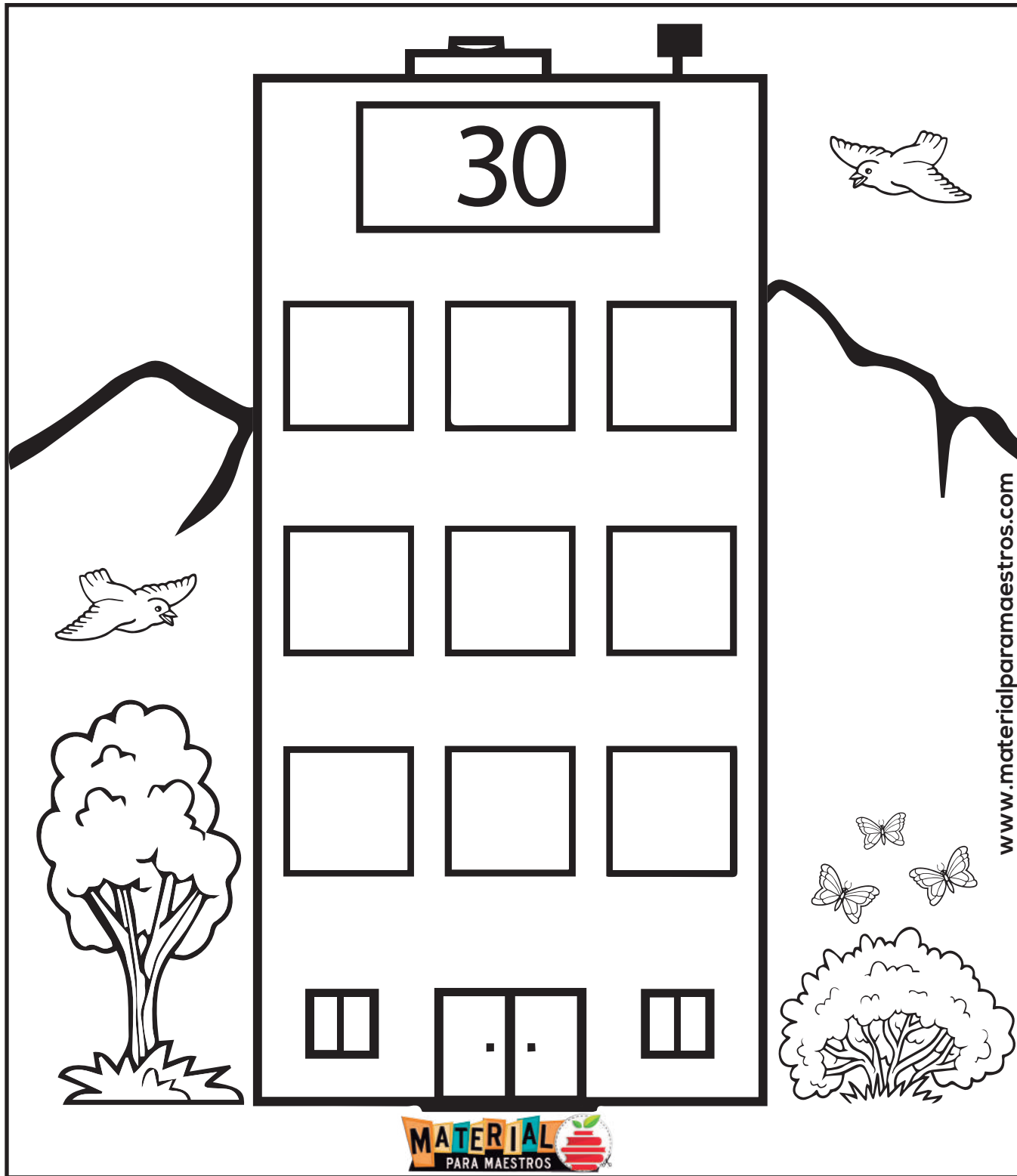

Recorta y pega donde corresponde.

31 32 33

34 35 36

37 38 39

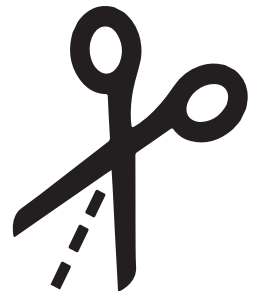
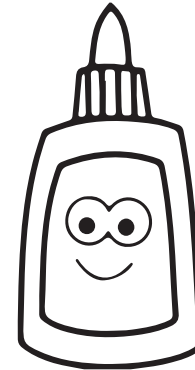

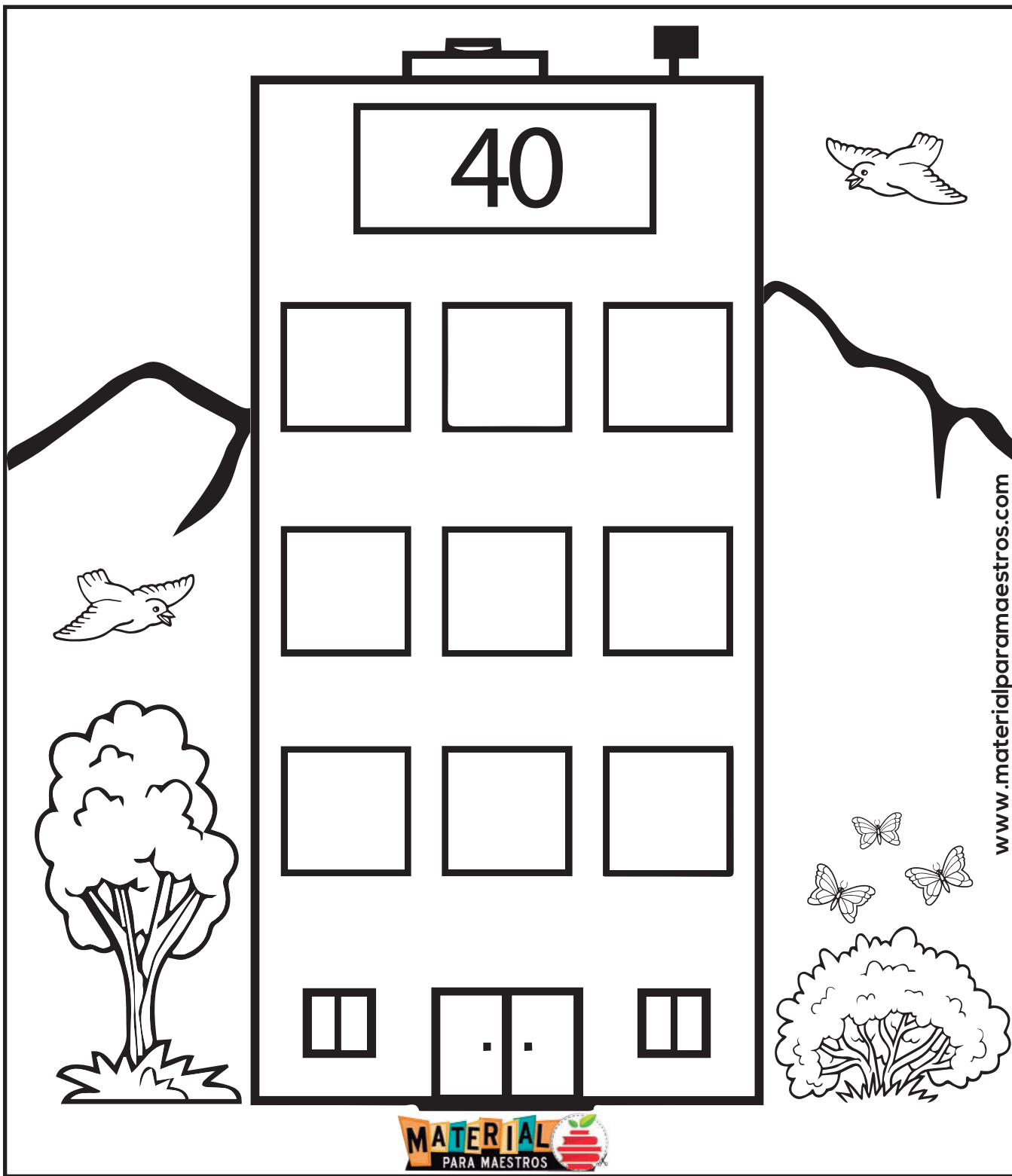

Recorta y pega donde corresponde.

41

42

43

44

45

46

47

48

49

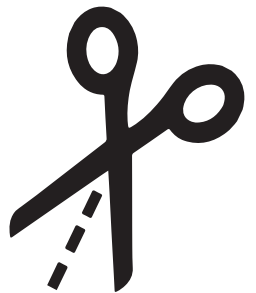
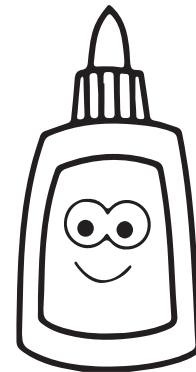

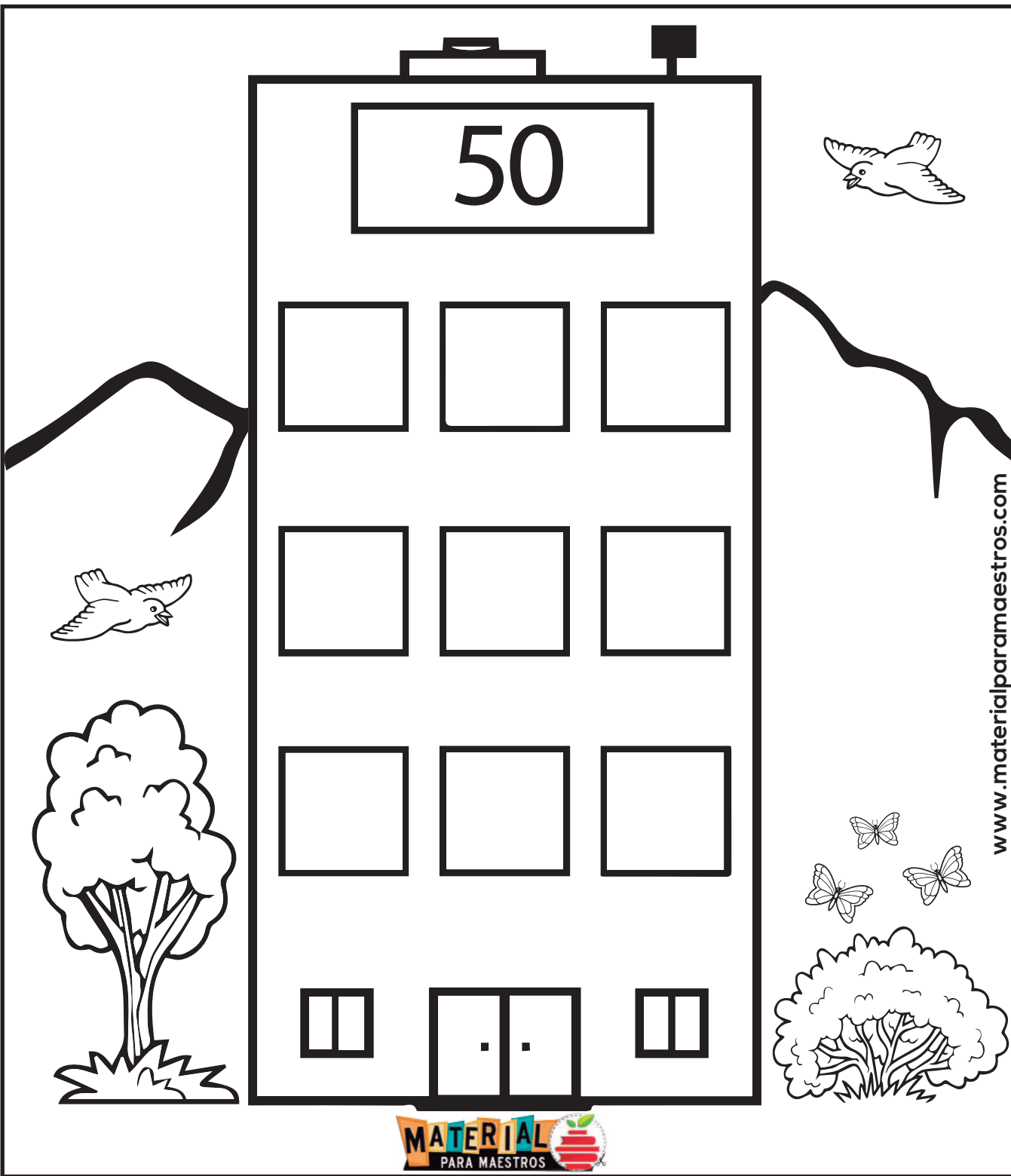

Recorta y pega donde corresponde.

51 52 53

54 55 56

57 58 59

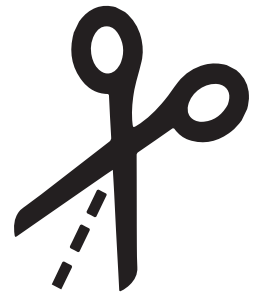
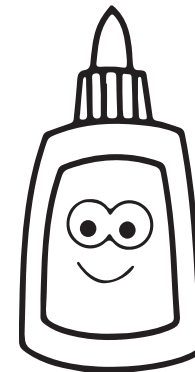

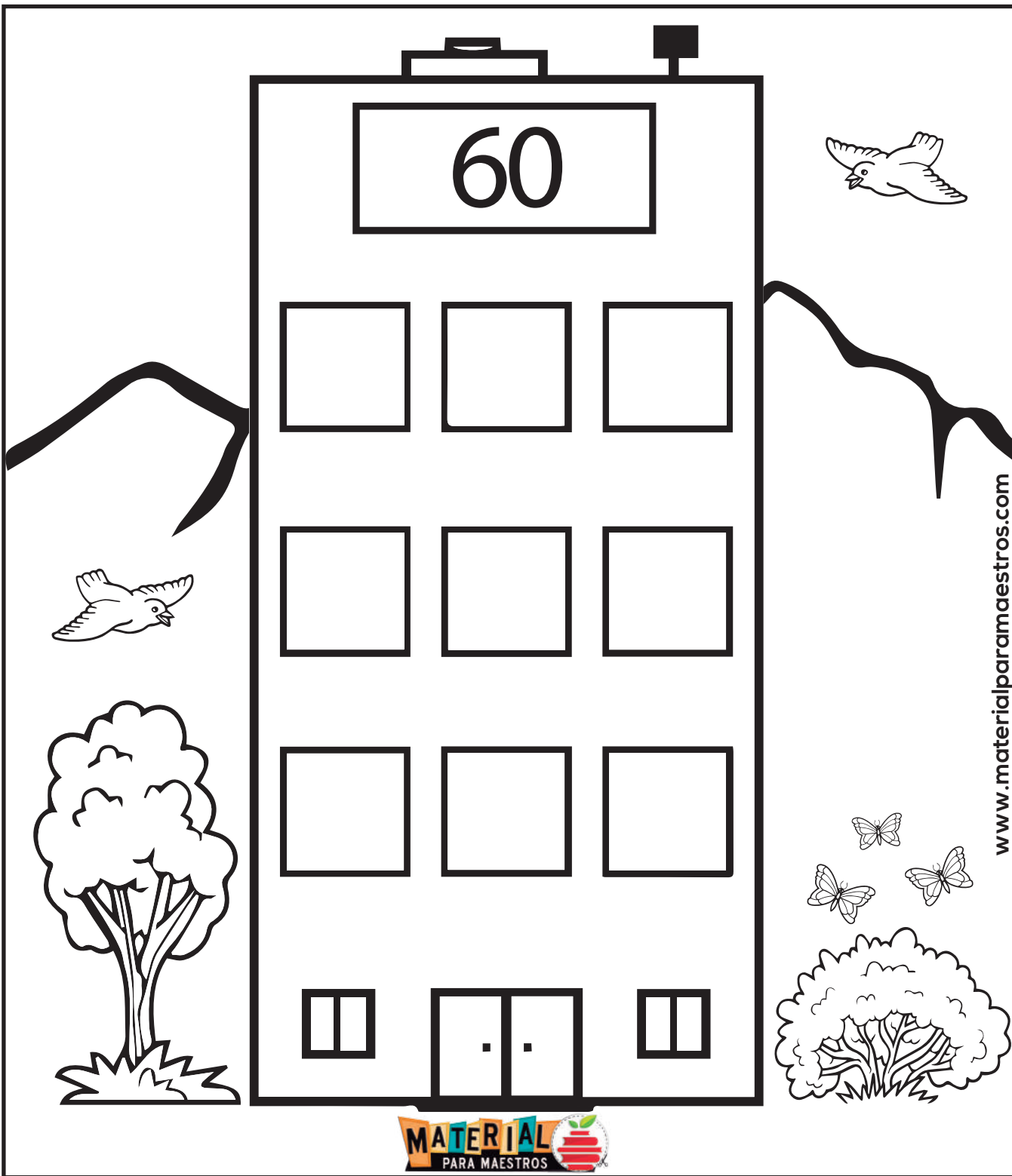

Recorta y pega donde corresponde.

61 62 63

64 65 66

67 68 69

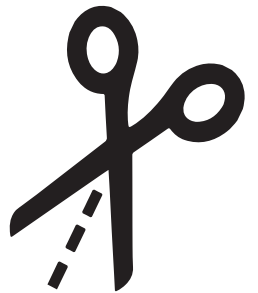
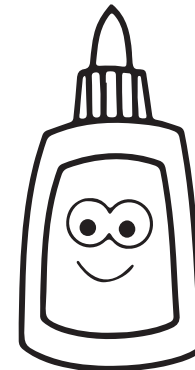

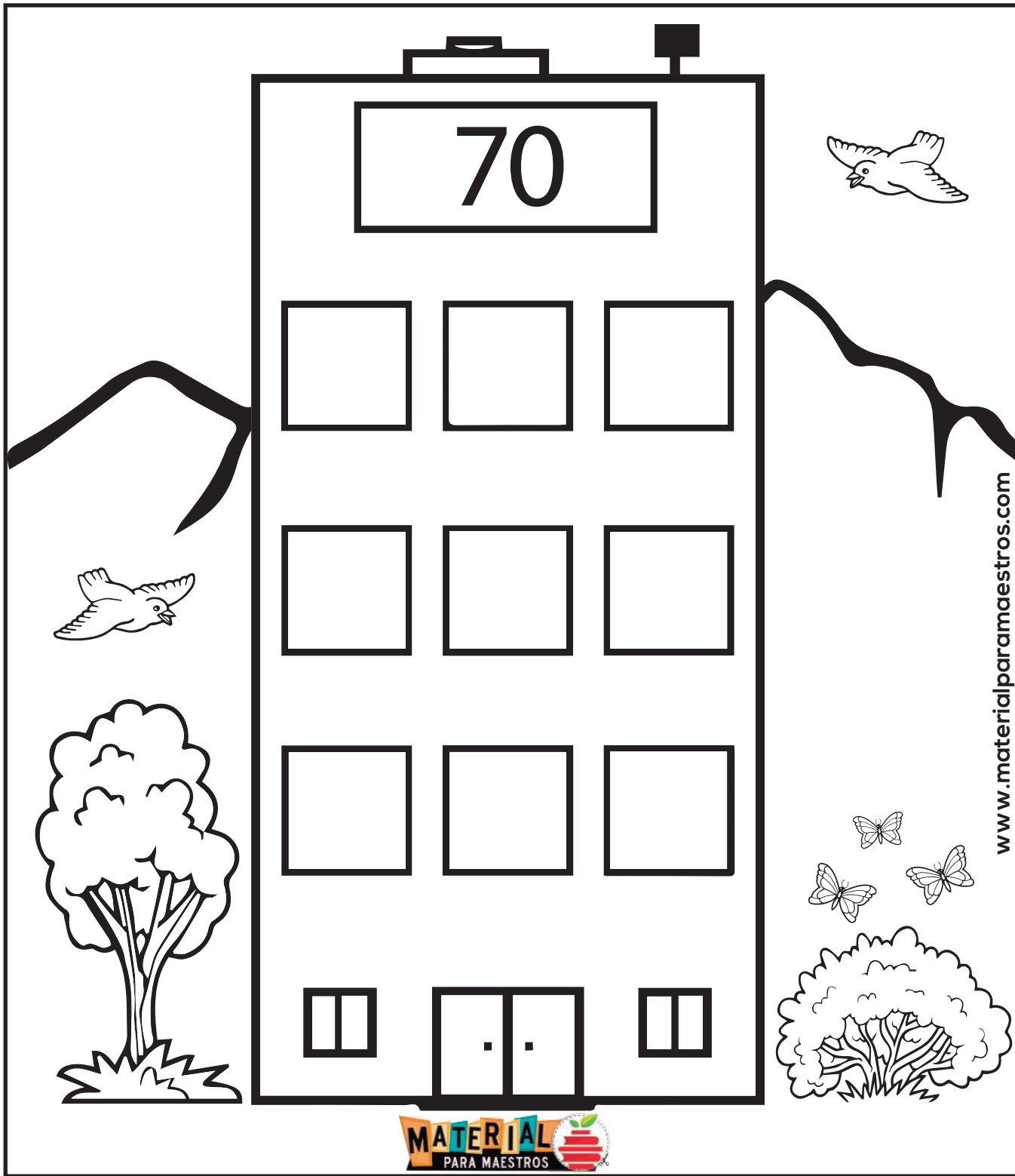

Recorta y pega donde corresponde.

71 72 73

74 75 76

77 78 79

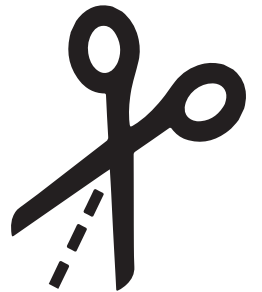
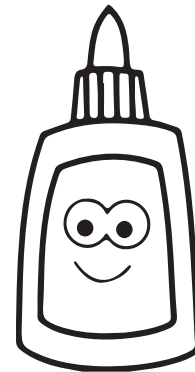

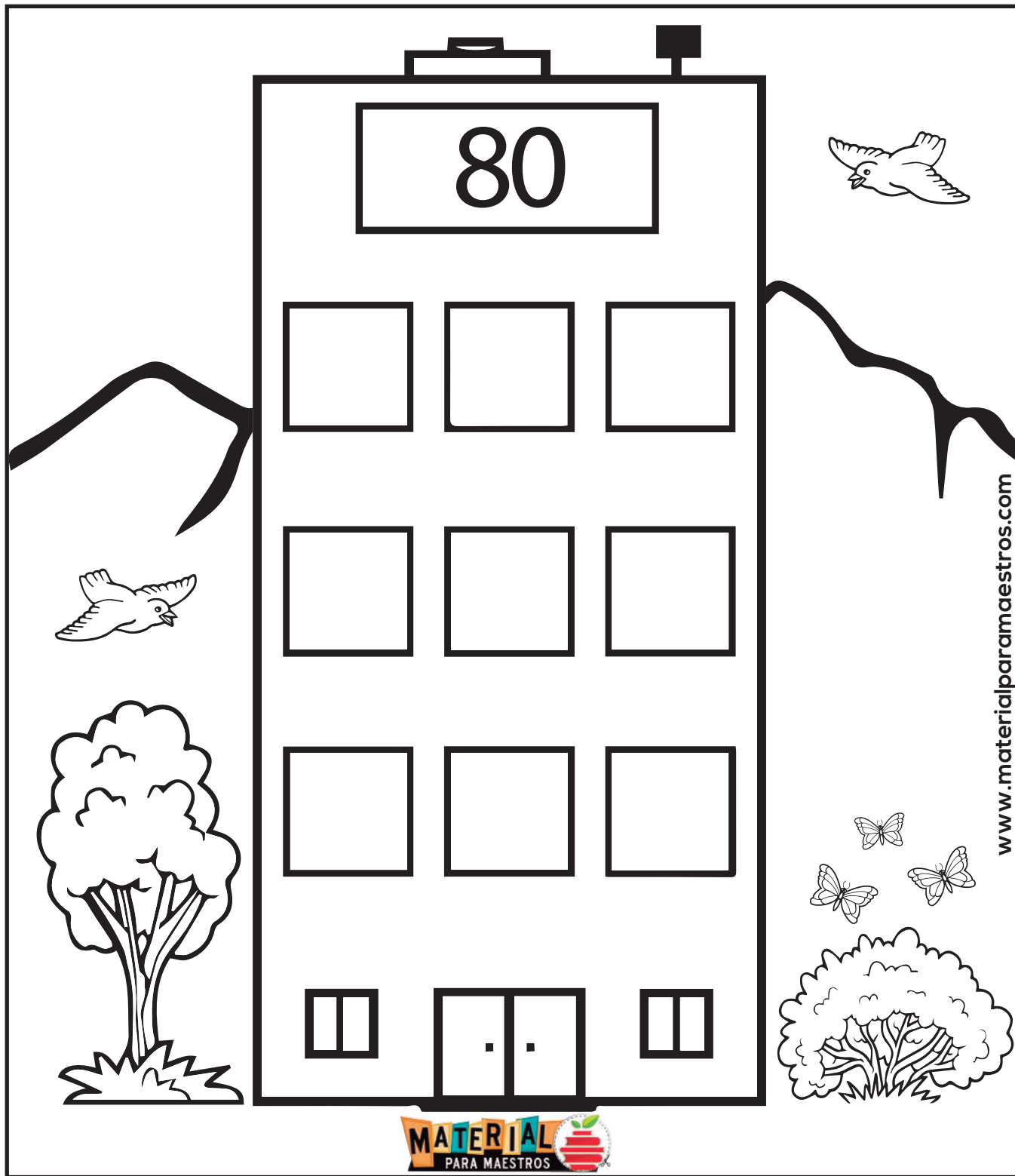

Recorta y pega donde corresponde.

81 82 83

84 85 86

87 88 89

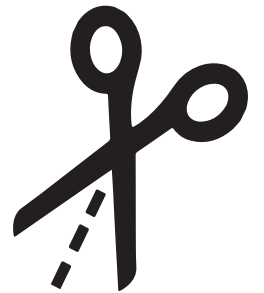
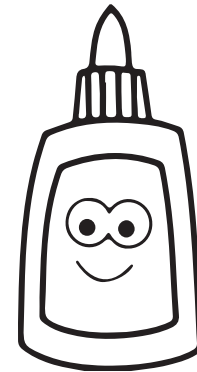

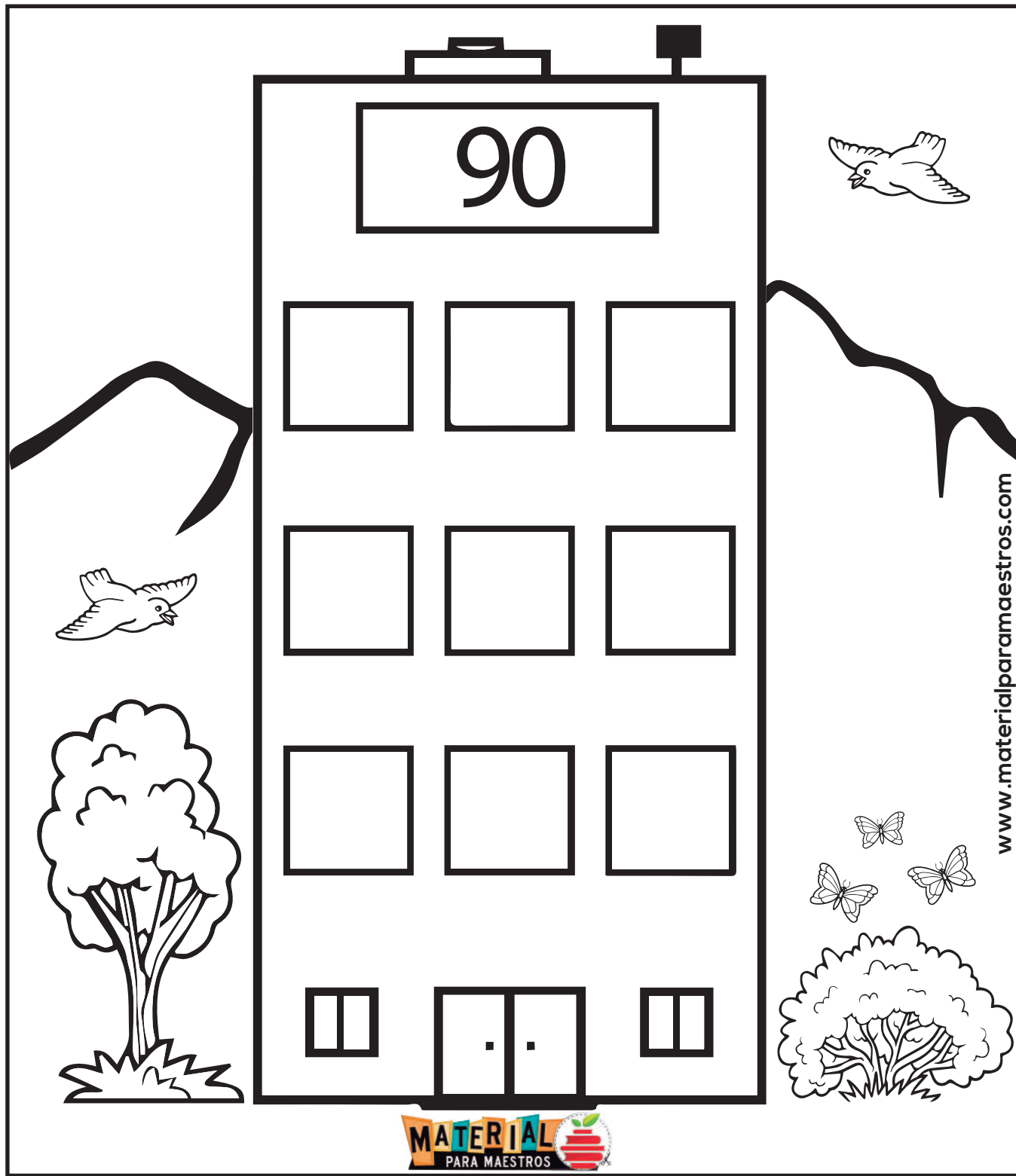

Recorta y pega donde corresponde.

91 92 93

94 95 96

97 98 99

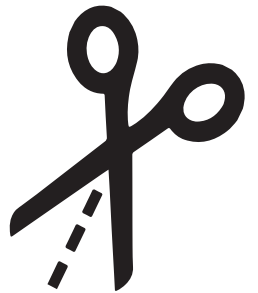
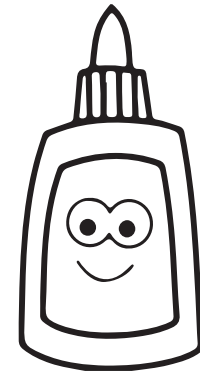

Los números

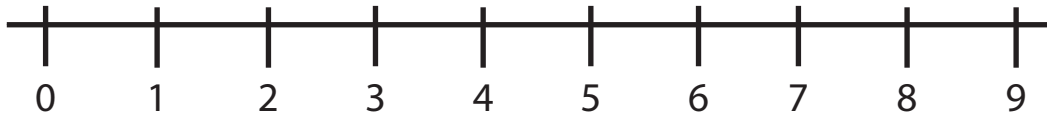

Escribe 4 veces el número con su nombre.

0. cero

5. cinco

1. uno

6. seis

2. dos

7. siete

3. tres

8. ocho

4. cuatro

9. nueve

Familia del 10

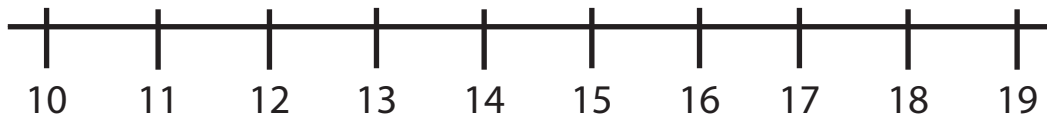

Escribe 4 veces el número con su nombre.

10. diez

15. quince

11. once

16. dieciseís

12. doce

17. diecisiete

13. trece

18. dieciocho

14. catorce

19. diecinueve

Familia del 20

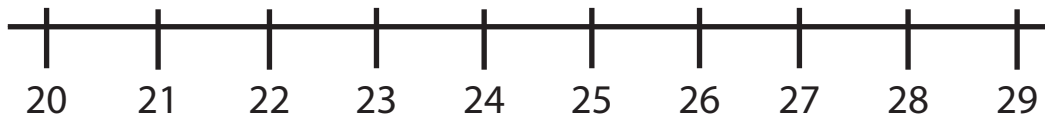

Escribe 4 veces el número con su nombre.

20. veinte

25. veinticinco

21. veintiuno

26. veintiséis

22. veintidós

27. veintisiete

23. veintitrés

28. veintiocho

24. veinticuatro

29. veintinueve

Familia del 30

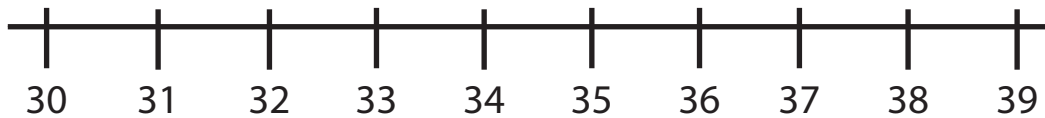

Escribe 4 veces el número con su nombre.

30. treinta

35. treinta y cinco

31. treinta y uno

36. treinta y seis

32. treinta y dos

37. treinta y siete

33. treinta y tres

38. treinta y ocho

34. treinta y cuatro

39. treinta y nueve

Familia del 40

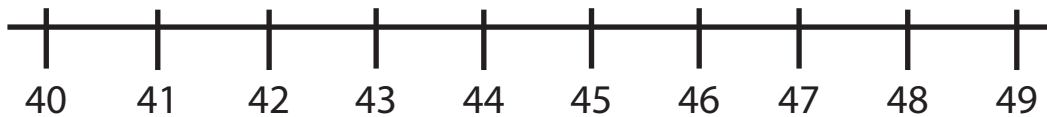

Escribe 4 veces el número con su nombre.

40. cuarenta

45. cuarenta y cinco

41. cuarenta y uno

46. cuarenta y seis

42. cuarenta y dos

47. cuarenta y siete

43. cuarenta y tres

48. cuarenta y ocho

44. cuarenta y cuatro

49. cuarenta y nueve

Familia del 50

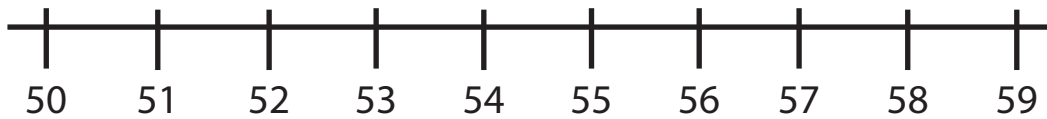

Escribe 4 veces el número con su nombre.

50. cincuenta

55. cincuenta y cinco

51. cincuenta y uno

56. cincuenta y seis

52. cincuenta y dos

57. cincuenta y siete

53. cincuenta y tres

58. cincuenta y ocho

54. cincuenta y cuatro

59. cincuenta y nueve

Familia del 60

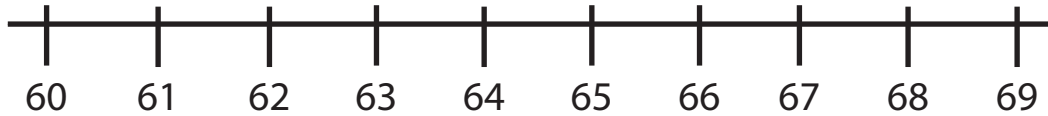

Escribe 4 veces el número con su nombre.

60. sesenta

65. sesenta y cinco

61. sesenta y uno

66. sesenta y seis

62. sesenta y dos

67. sesenta y siete

63. sesenta y tres

68. sesenta y ocho

64. sesenta y cuatro

69. sesenta y nueve

Familia del 70

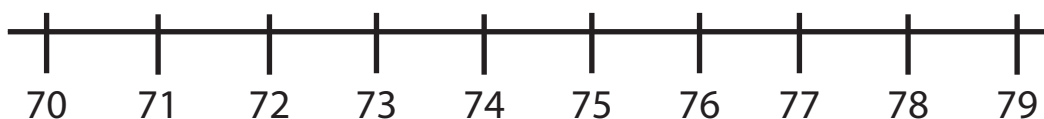

Escribe 4 veces el número con su nombre.

70. setenta

75. setenta y cinco

71. setenta y uno

76. setenta y seis

72. setenta y dos

77. setenta y siete

73. setenta y tres

78. setenta y ocho

74. setenta y cuatro

79. setenta y nueve

Familia del 80

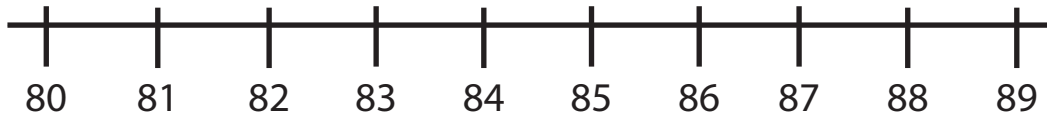

Escribe 4 veces el número con su nombre.

80. ochenta

85. ochenta y cinco

81. ochenta y uno

86. ochenta y seis

82. ochenta y dos

87. ochenta y siete

83. ochenta y tres

88. ochenta y ocho

84. ochenta y cuatro

89. ochenta y nueve

Familia del 90

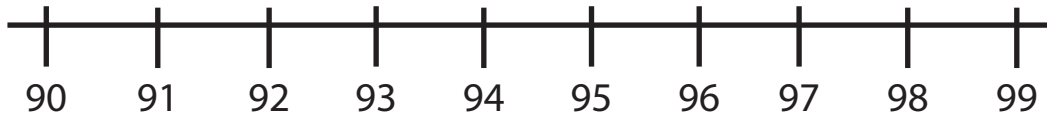

Escribe 4 veces el número con su nombre.

90. noventa

95. noventa y cinco

91. noventa y uno

96. noventa y seis

92. noventa y dos

97. noventa y siete

93. noventa y tres

98. noventa y ocho

94. noventa y cuatro

99. noventa y nueve

Números por familia

10

_____	_____	_____
_____	_____	_____
_____	_____	_____

20

_____	_____	_____
_____	_____	_____
_____	_____	_____

30

_____	_____	_____
_____	_____	_____
_____	_____	_____

www.materialparamaestros.com

40

_____	_____	_____
_____	_____	_____
_____	_____	_____

50

_____	_____	_____
_____	_____	_____
_____	_____	_____

60

_____	_____	_____
_____	_____	_____
_____	_____	_____

www.materialparamaestros.com

70

_____	_____	_____
_____	_____	_____
_____	_____	_____

80

_____	_____	_____
_____	_____	_____
_____	_____	_____

90

_____	_____	_____
_____	_____	_____
_____	_____	_____