

CUADERNILLO DE
preescolar

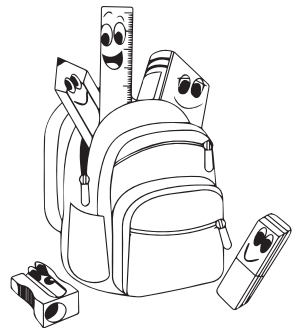

Nombre:

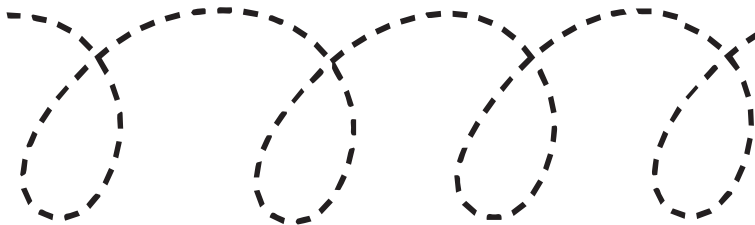

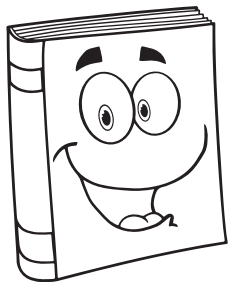
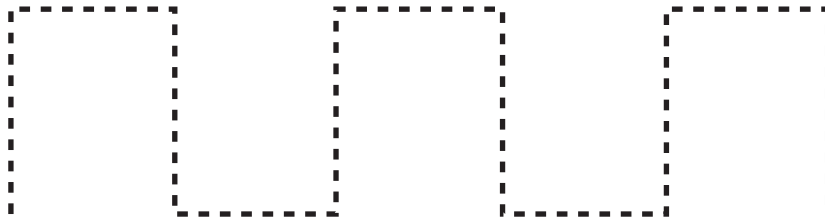
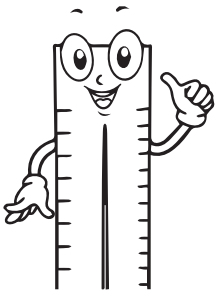
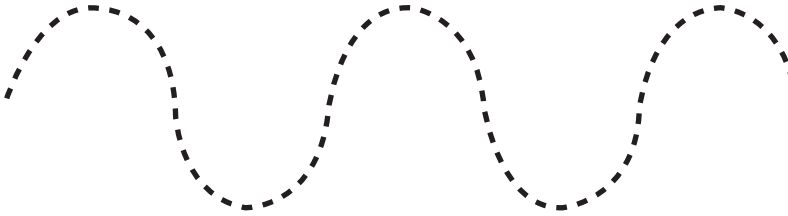
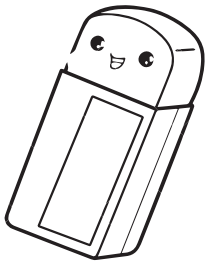
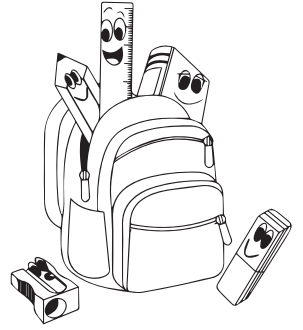
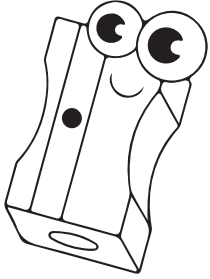
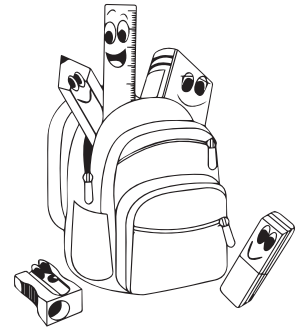
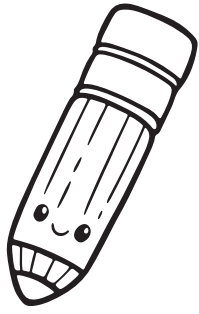
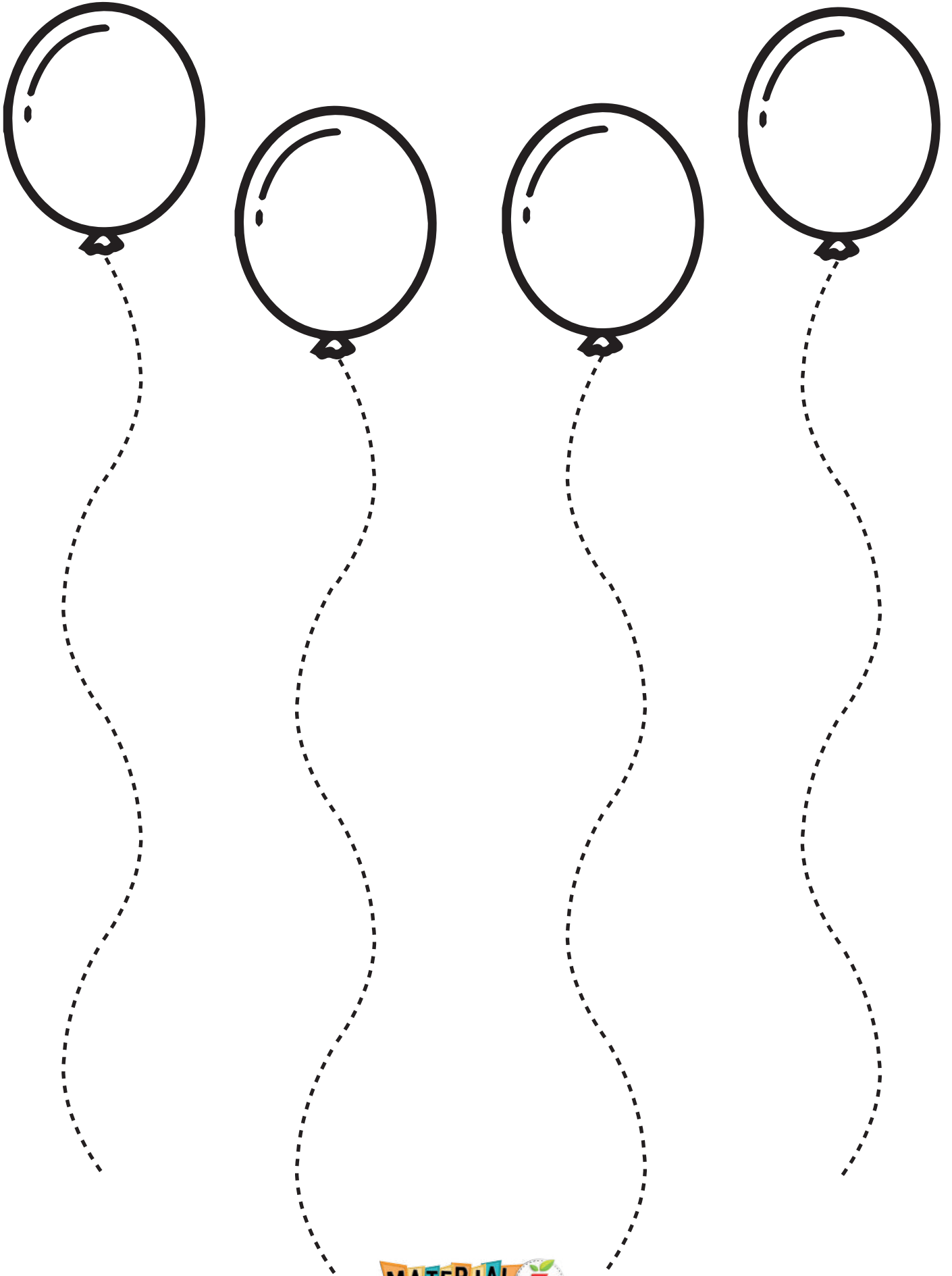

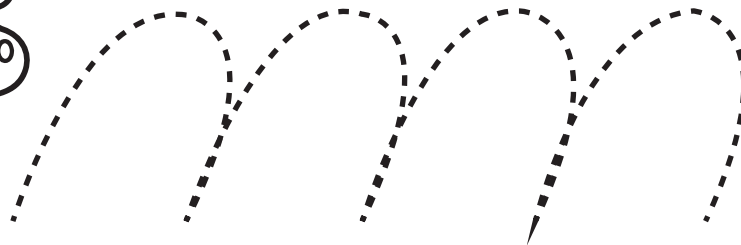
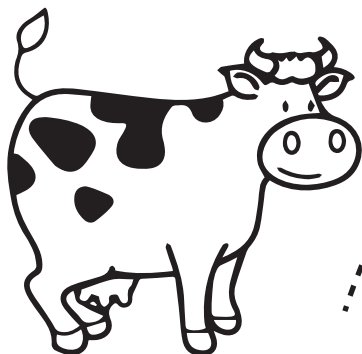
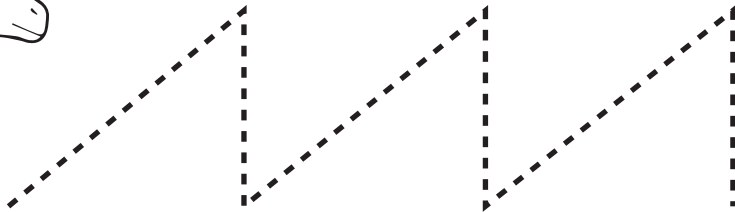
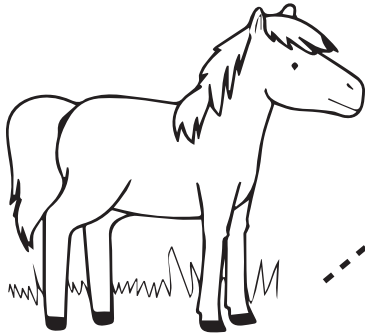
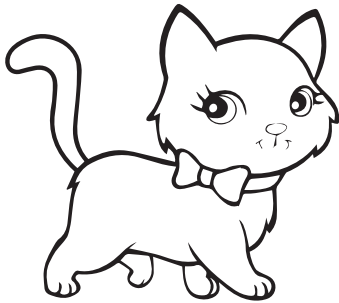
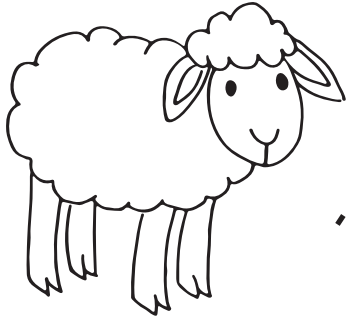

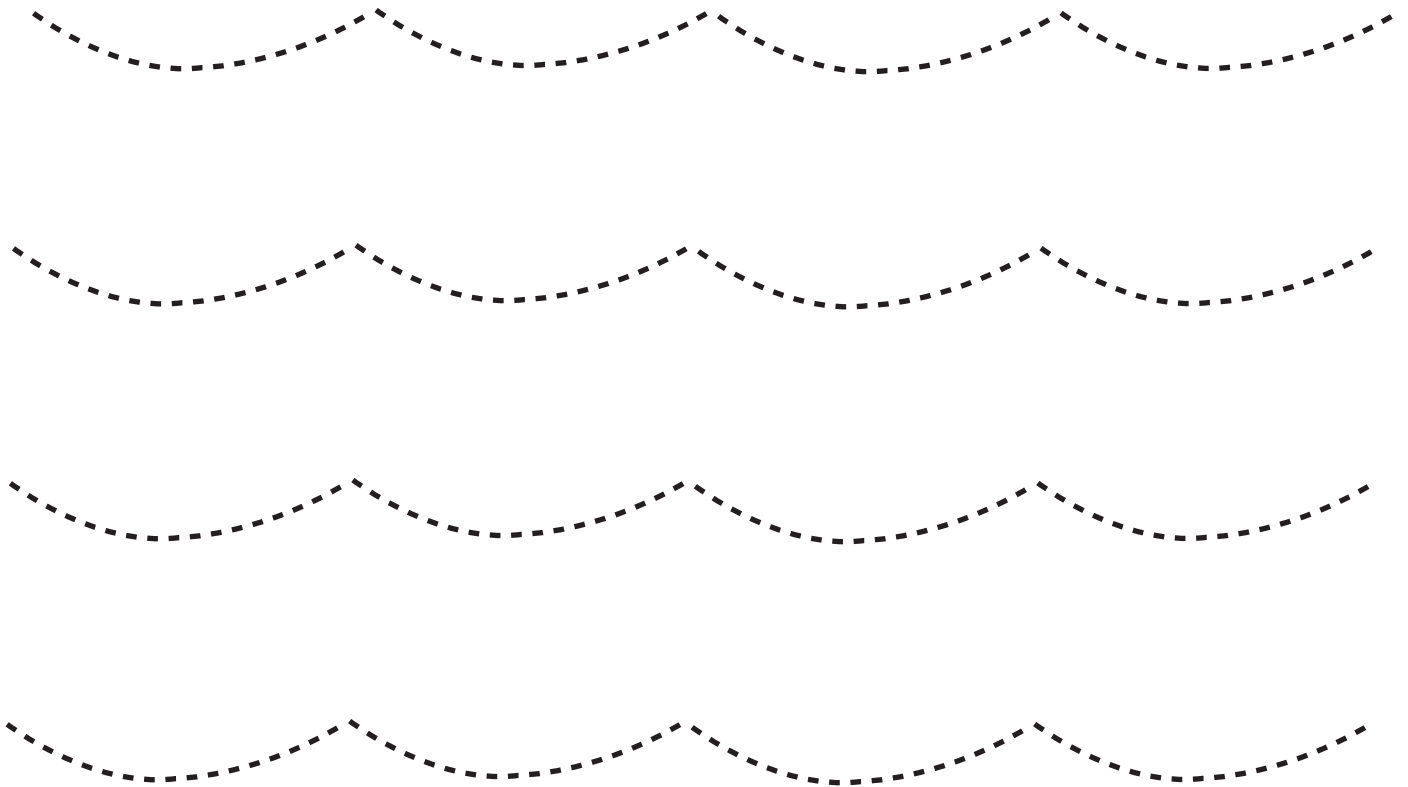
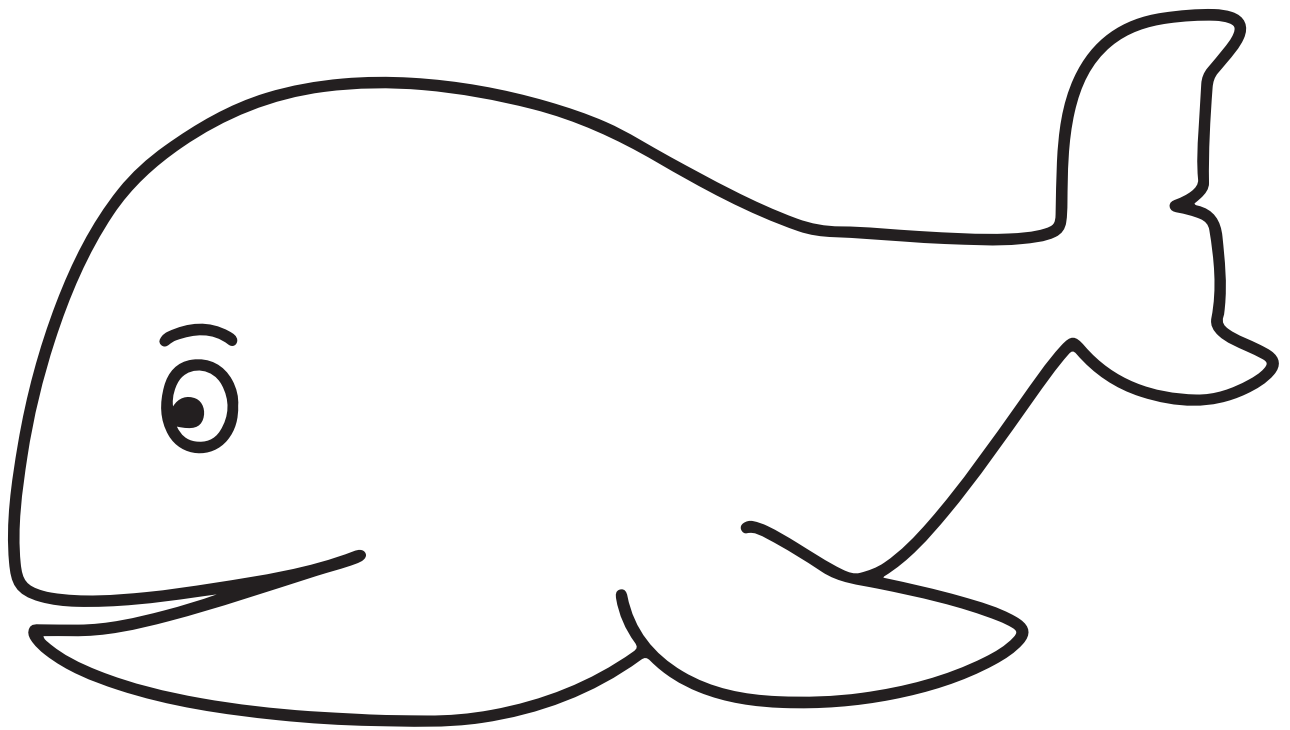

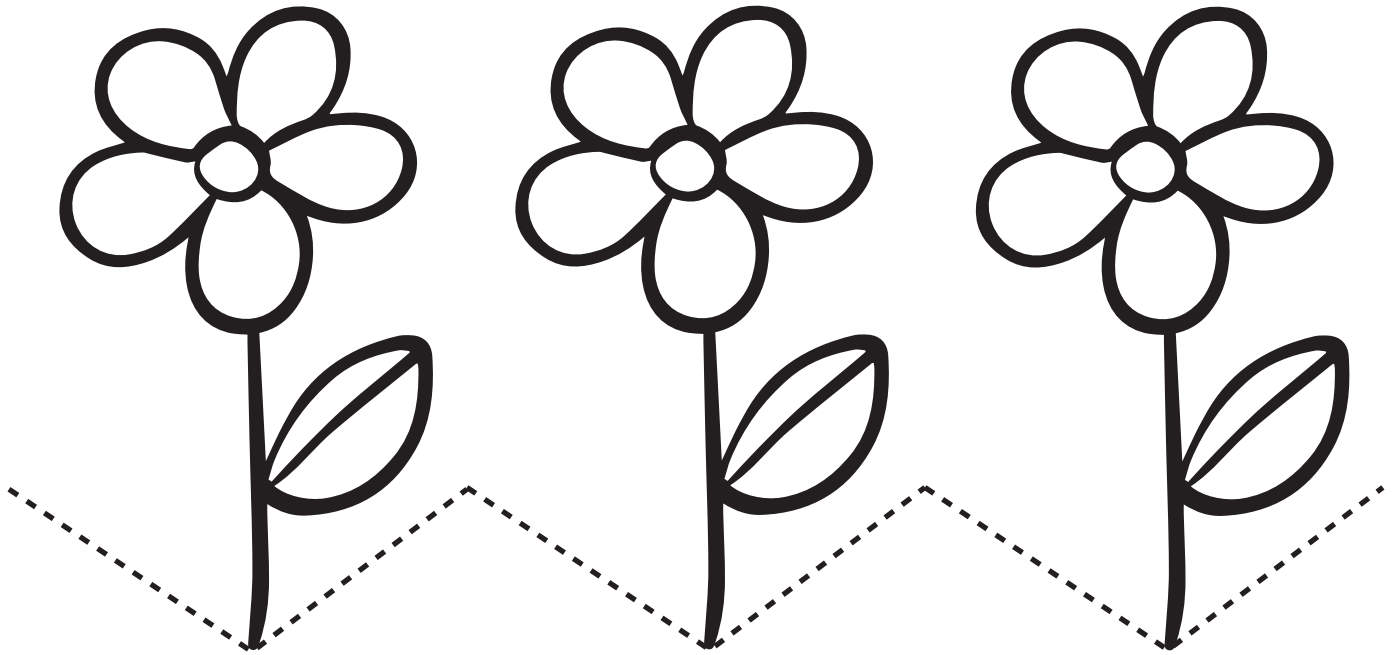

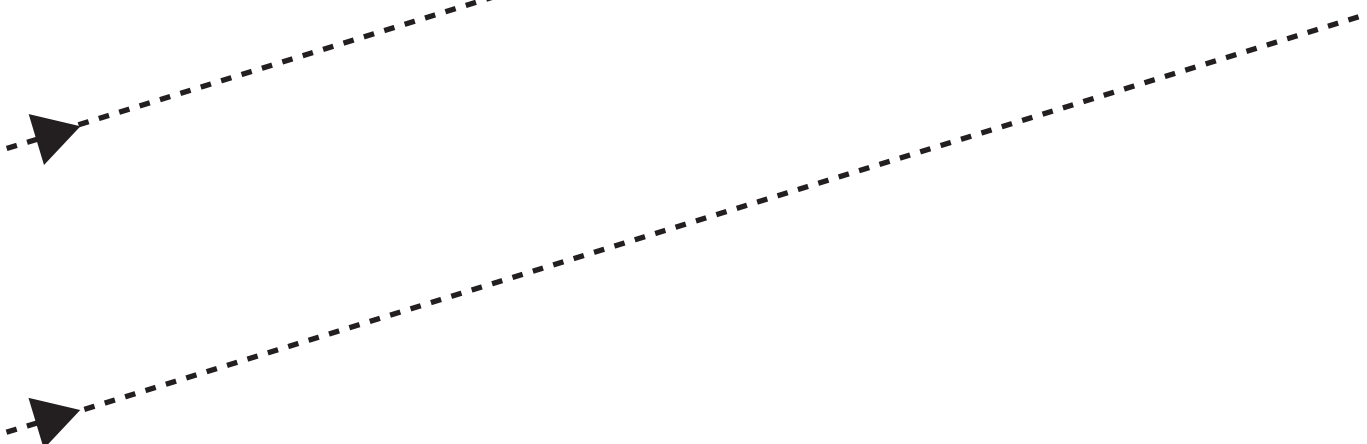
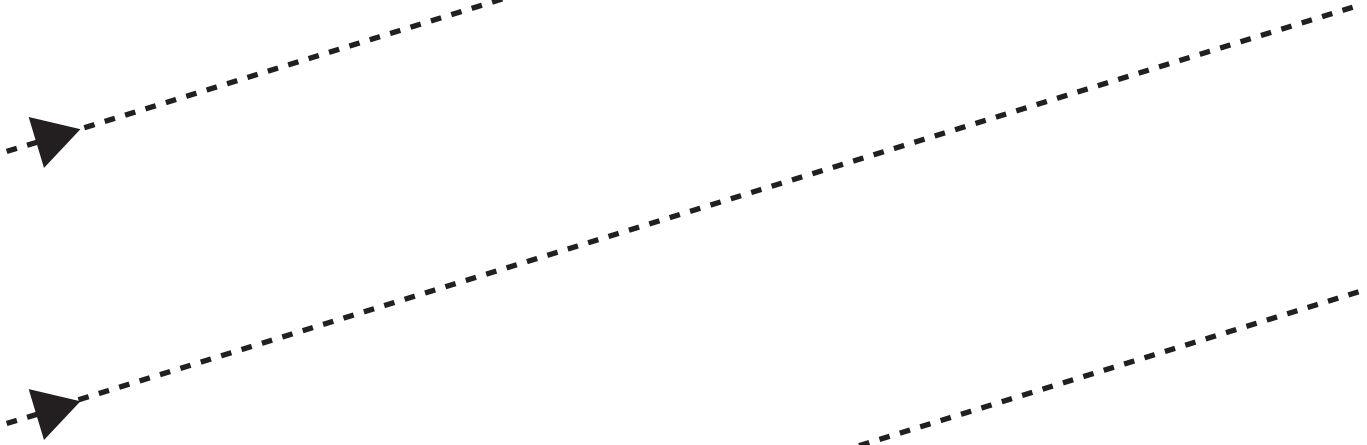
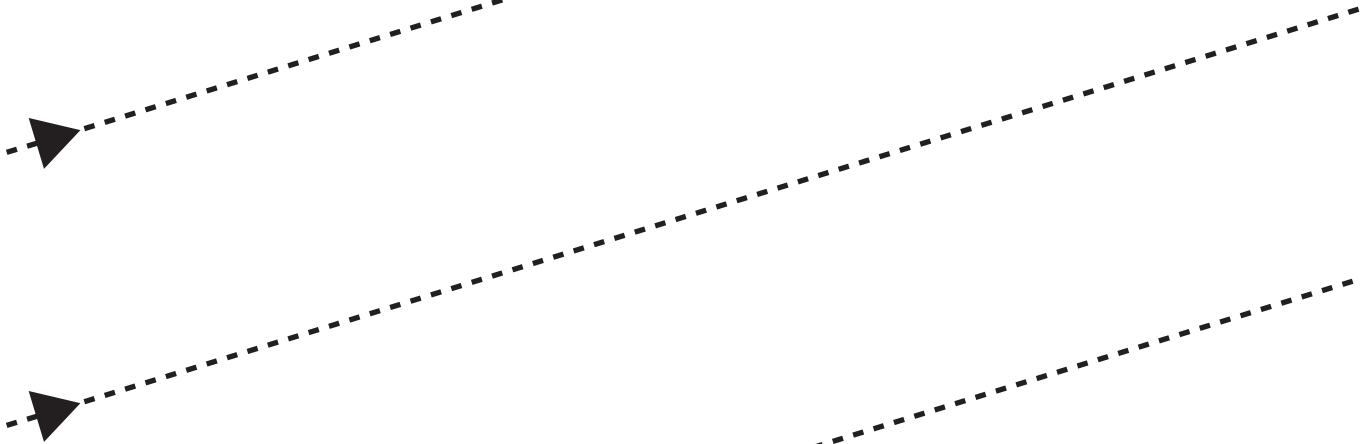
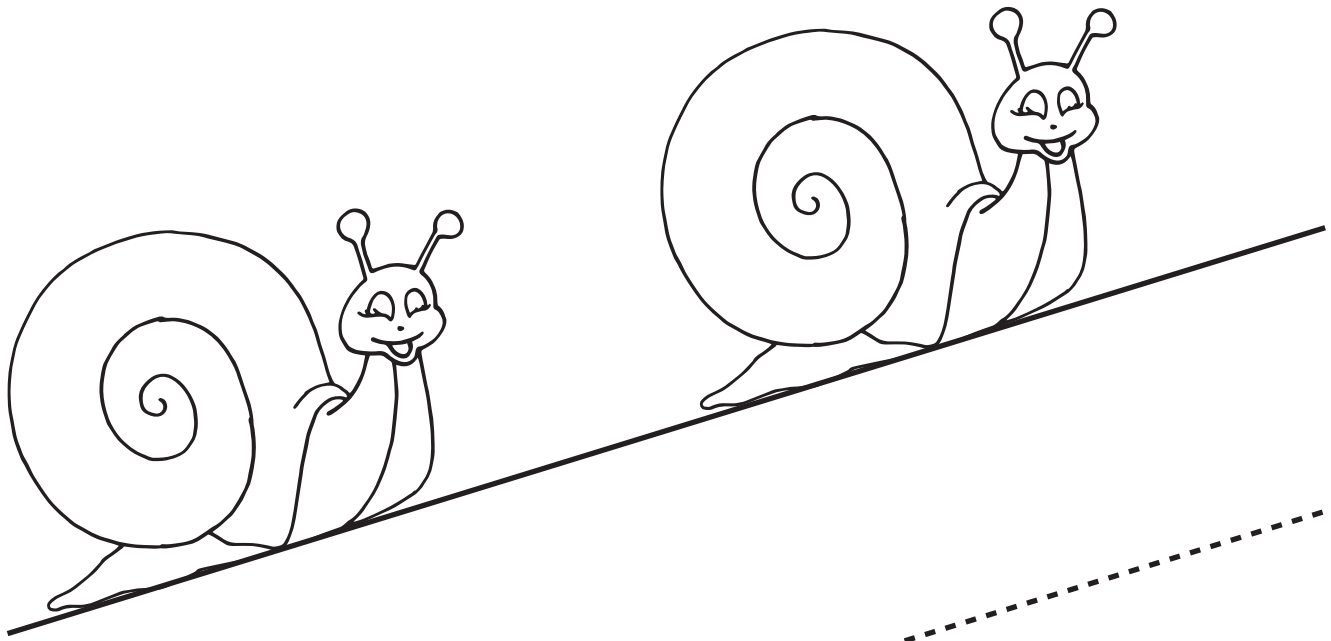

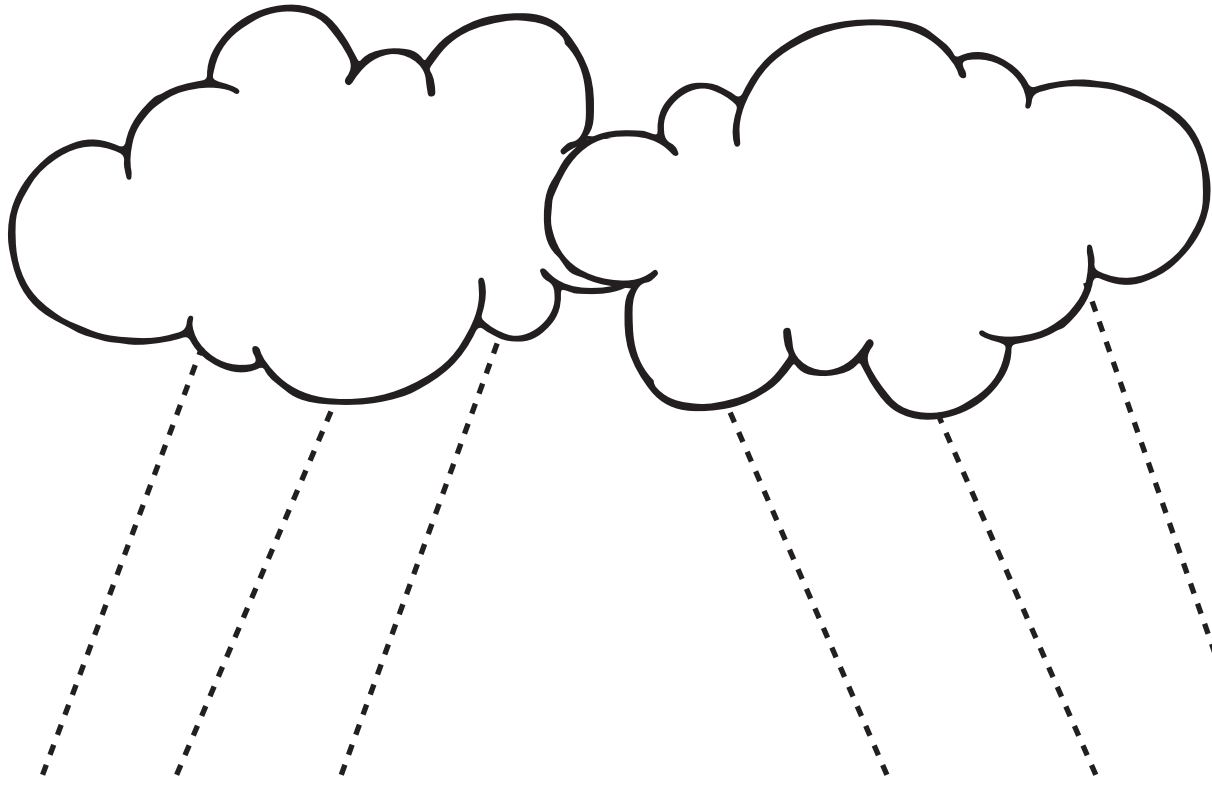

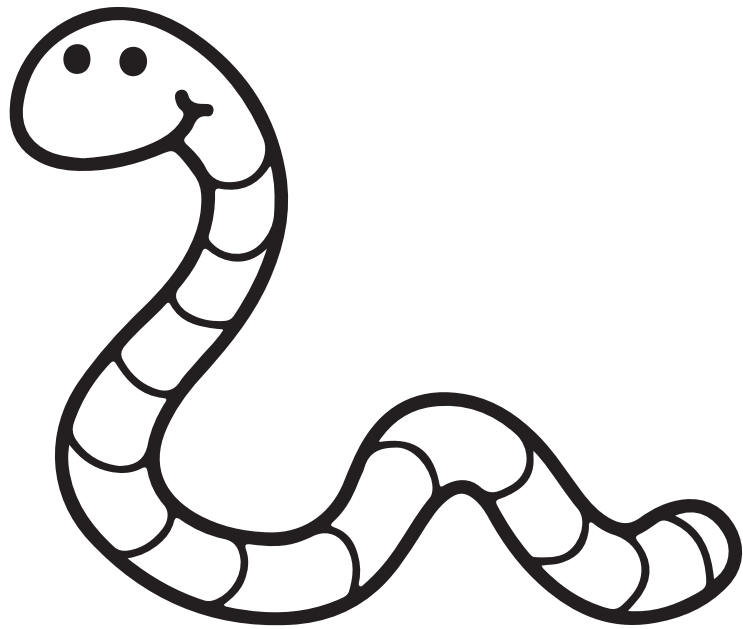

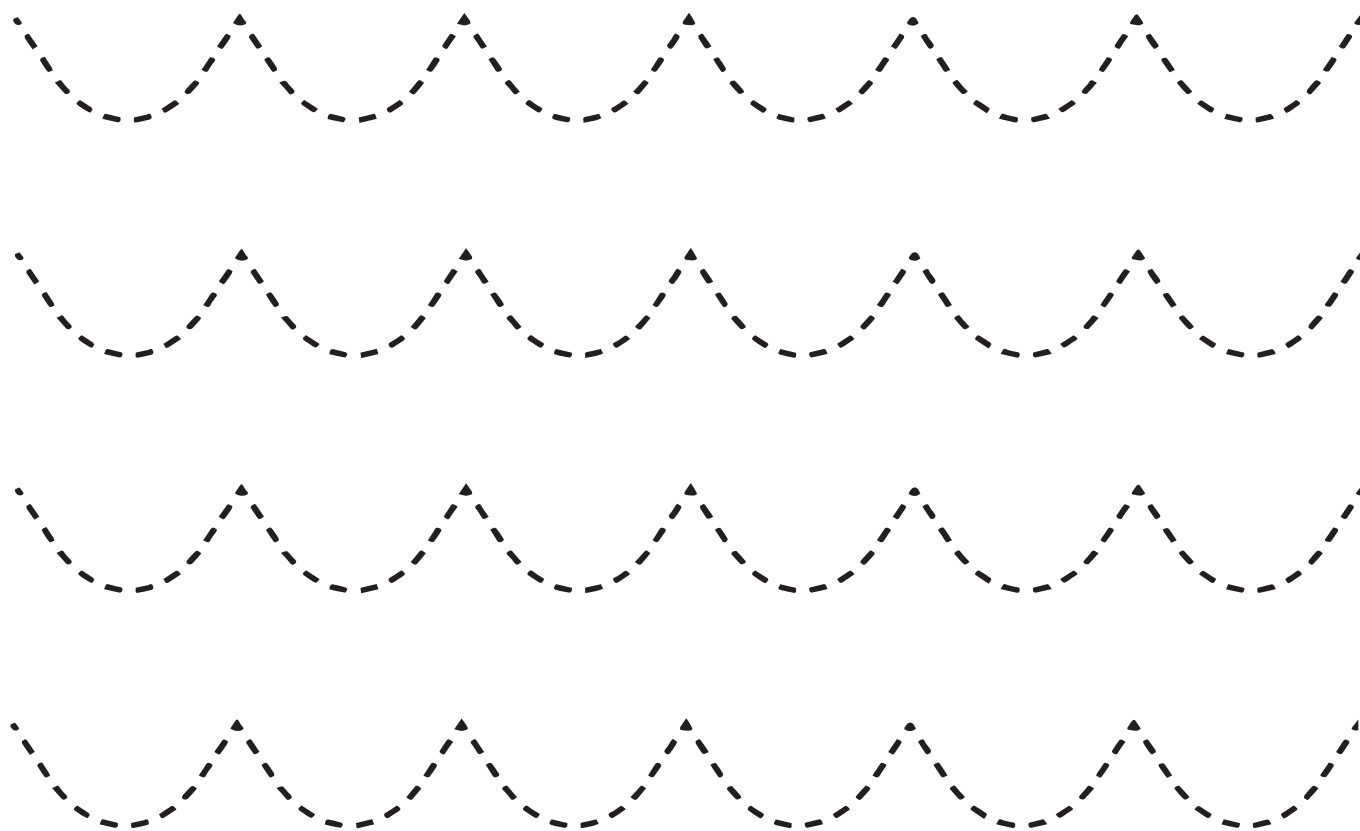

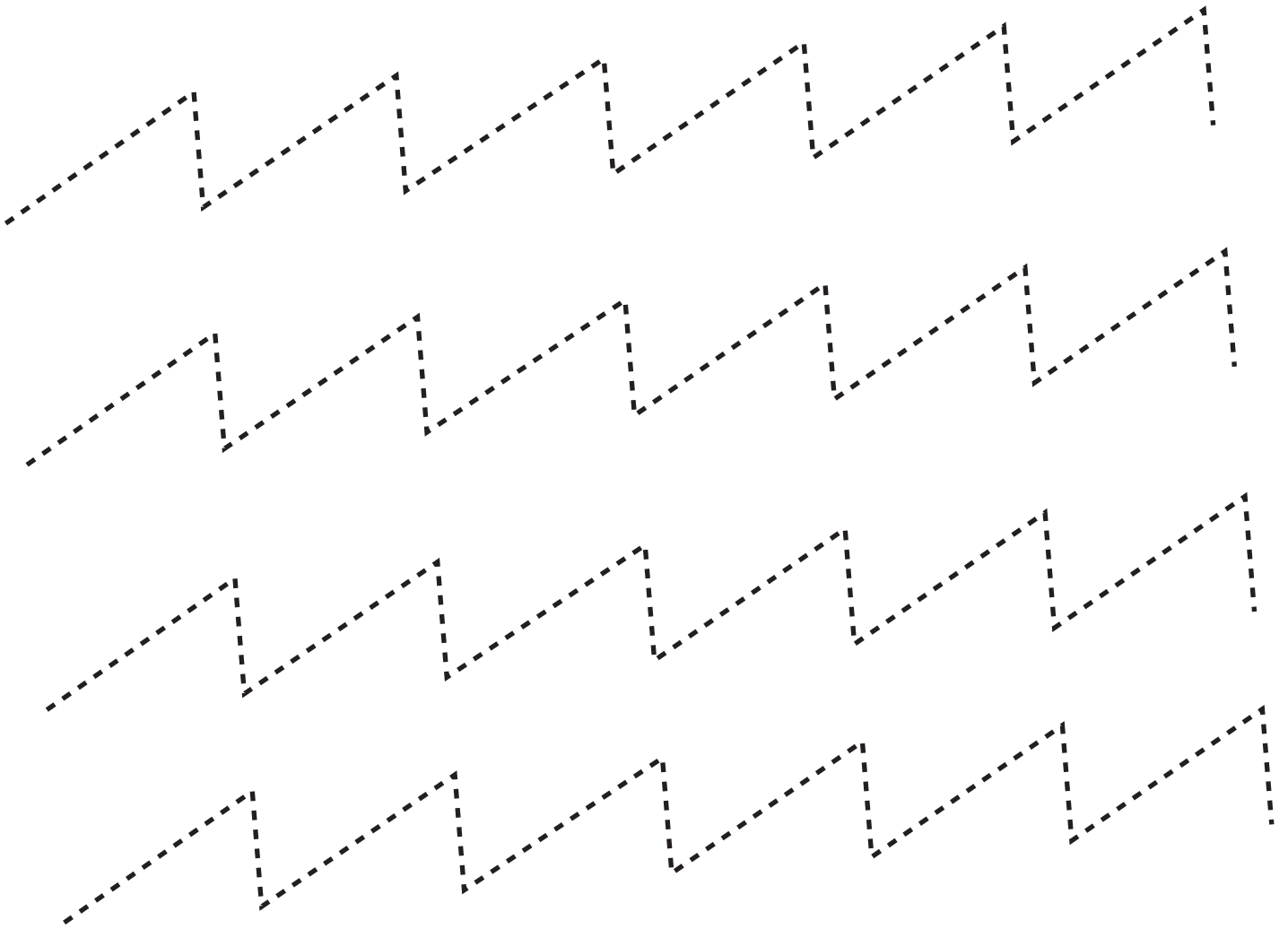
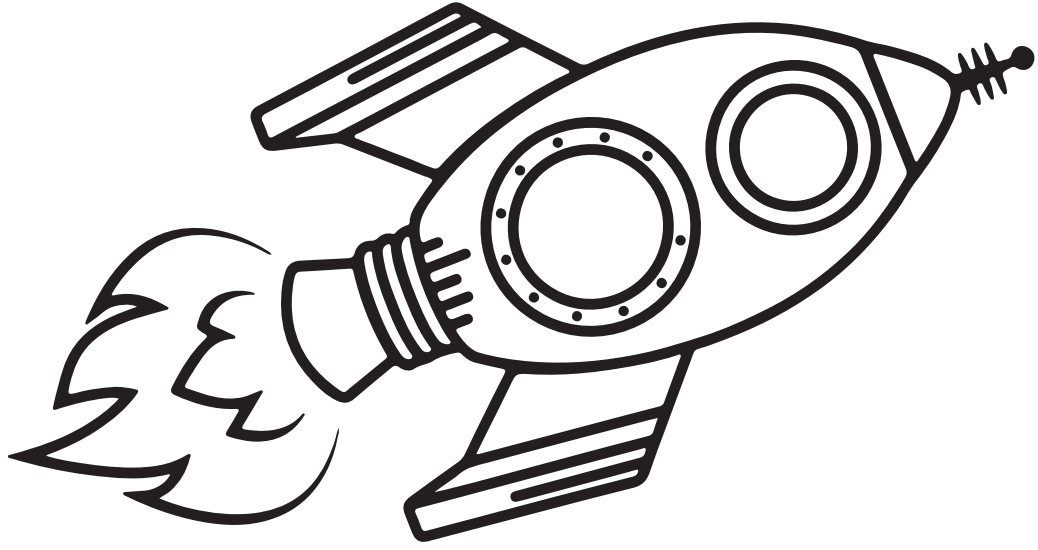

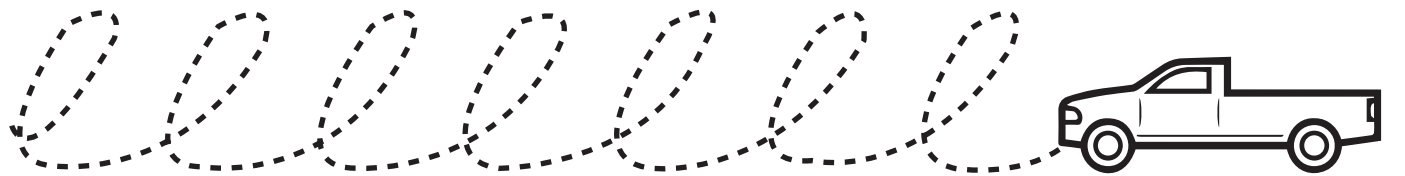
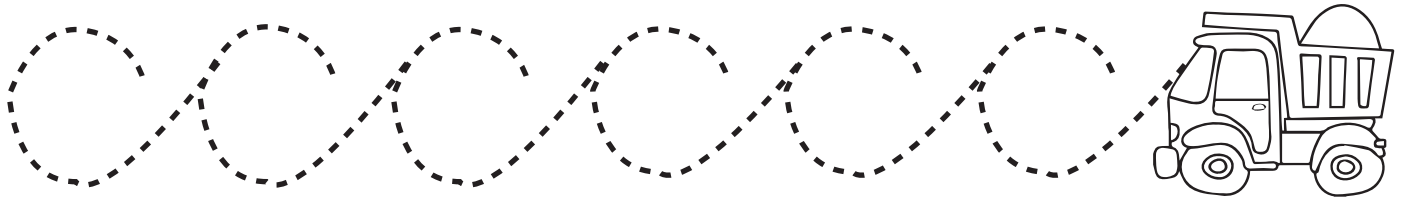
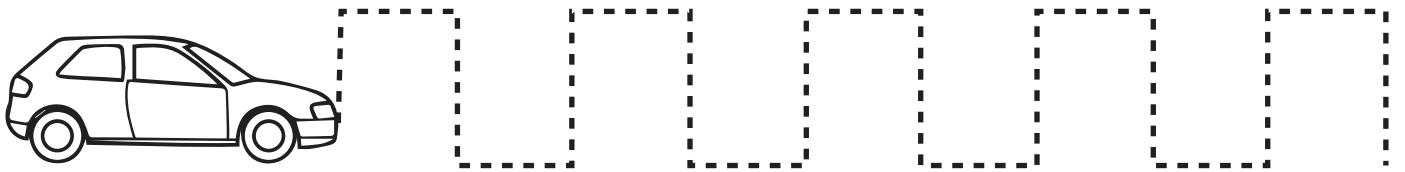

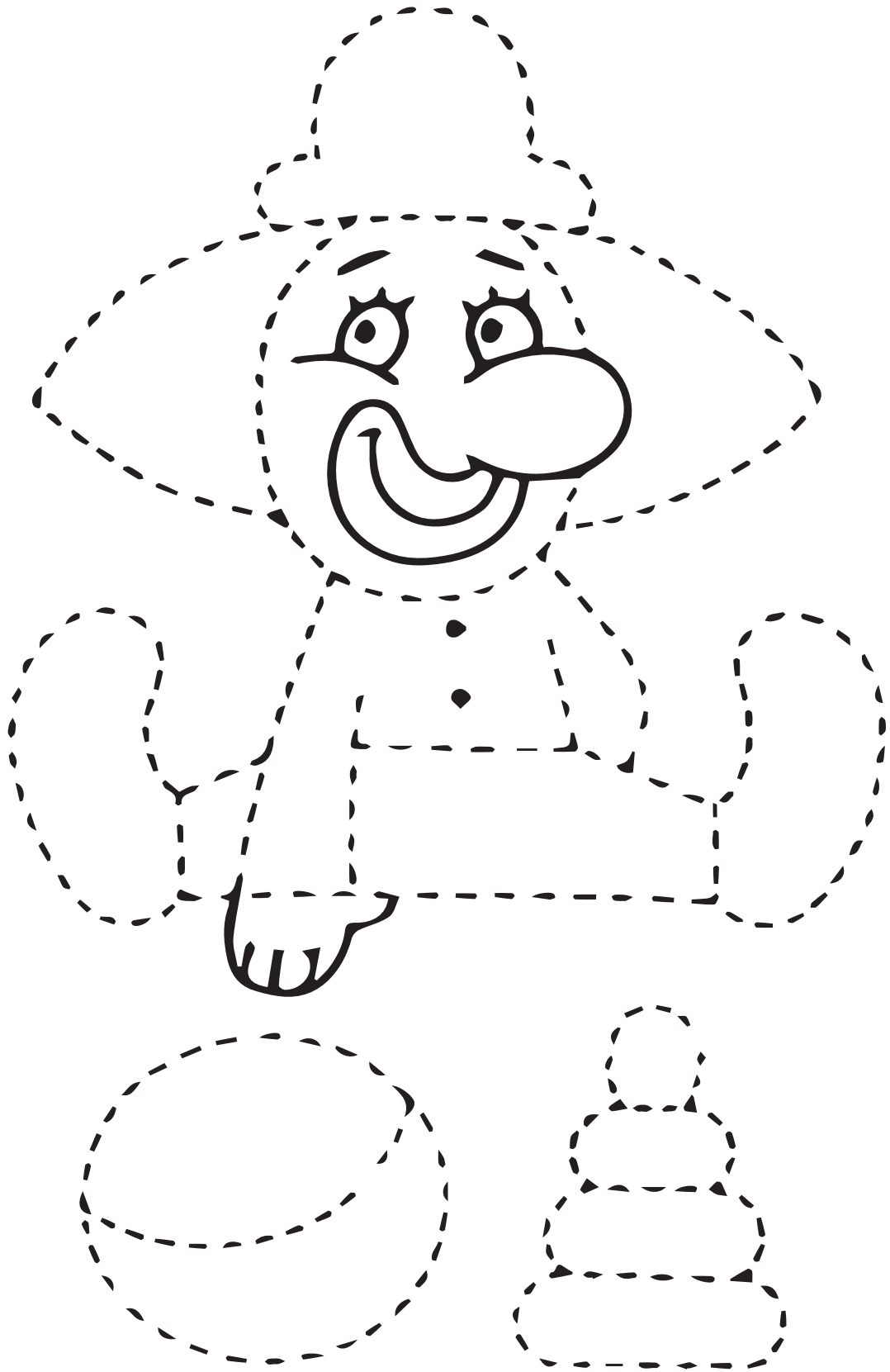

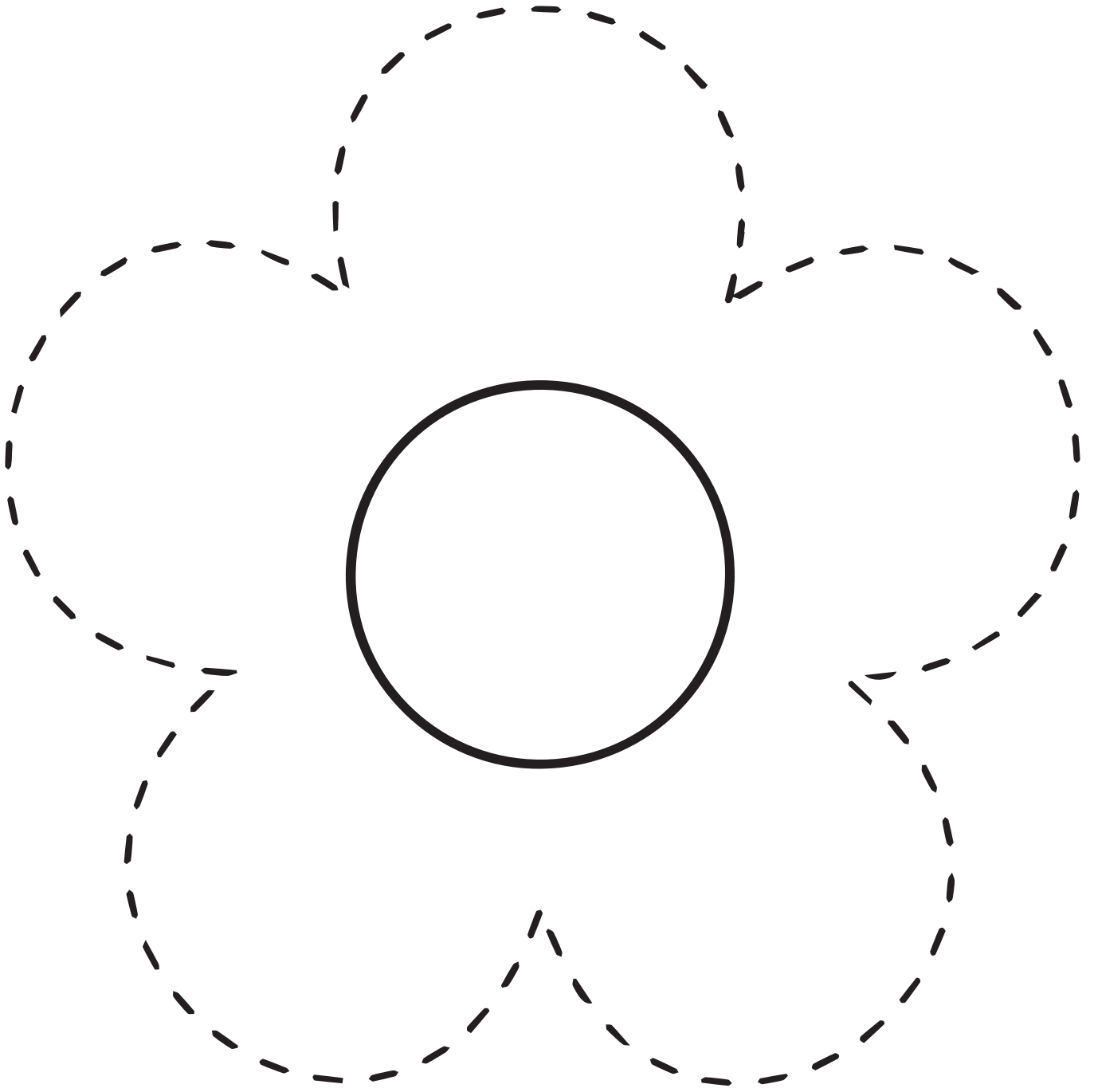

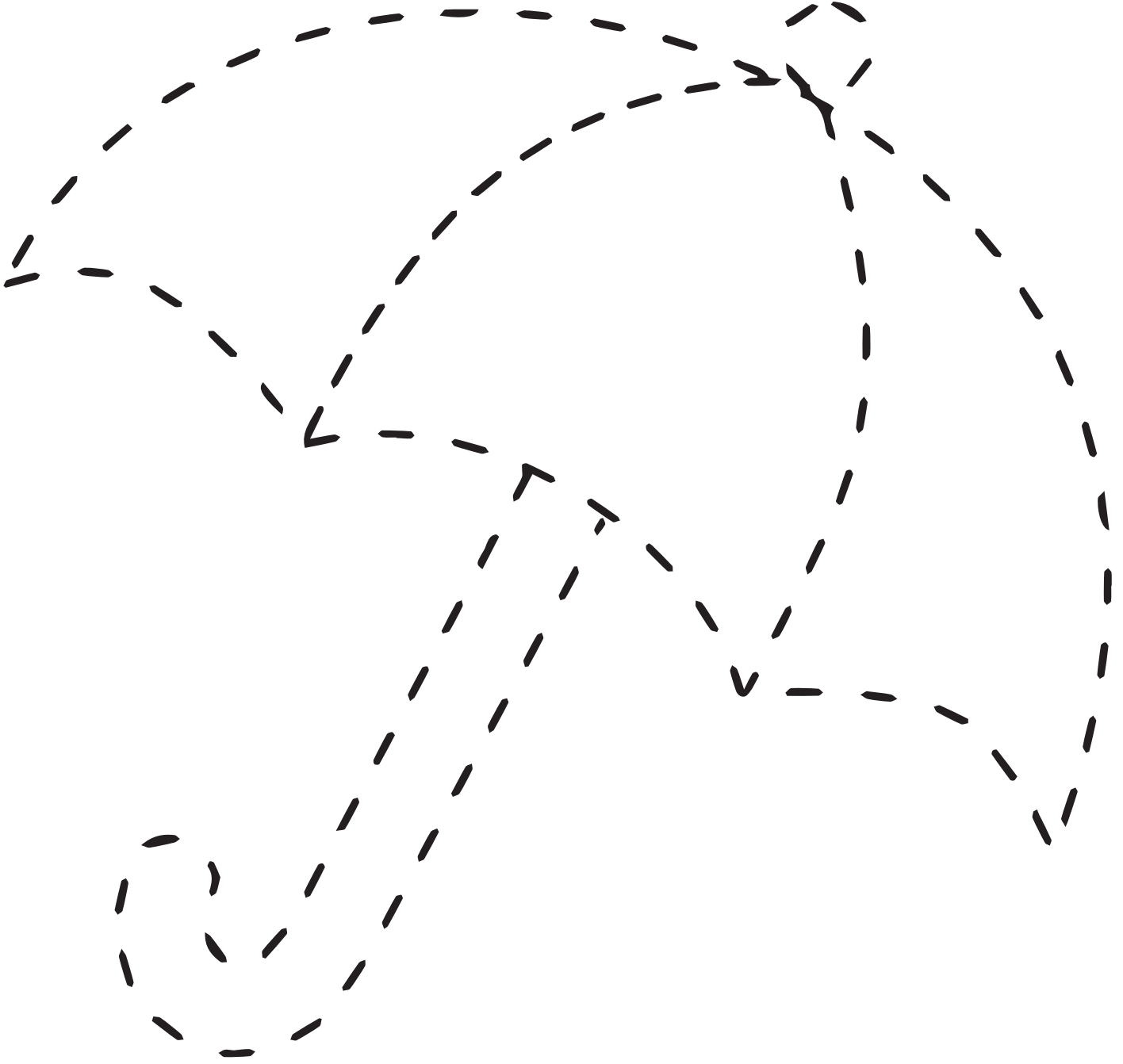

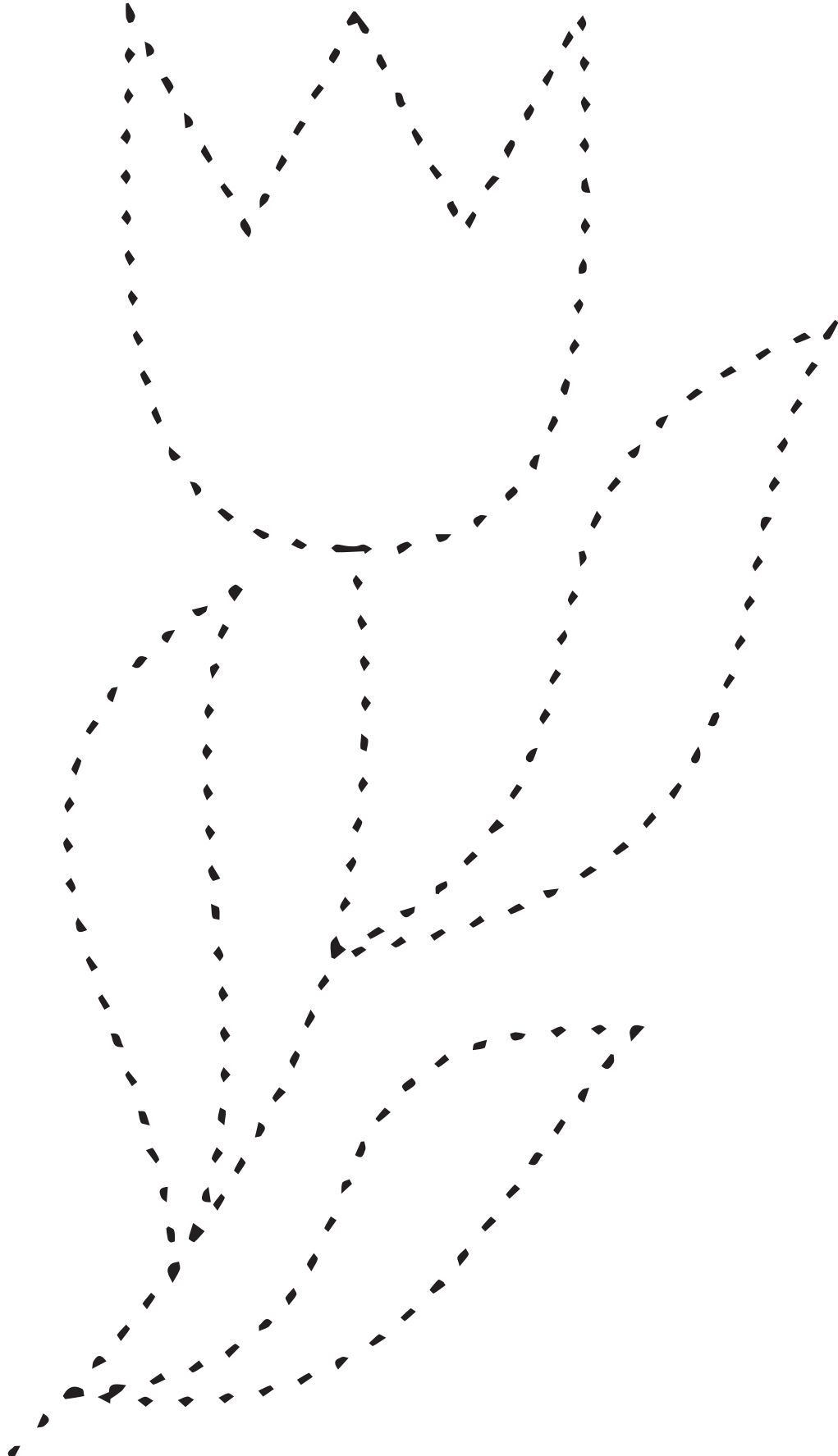

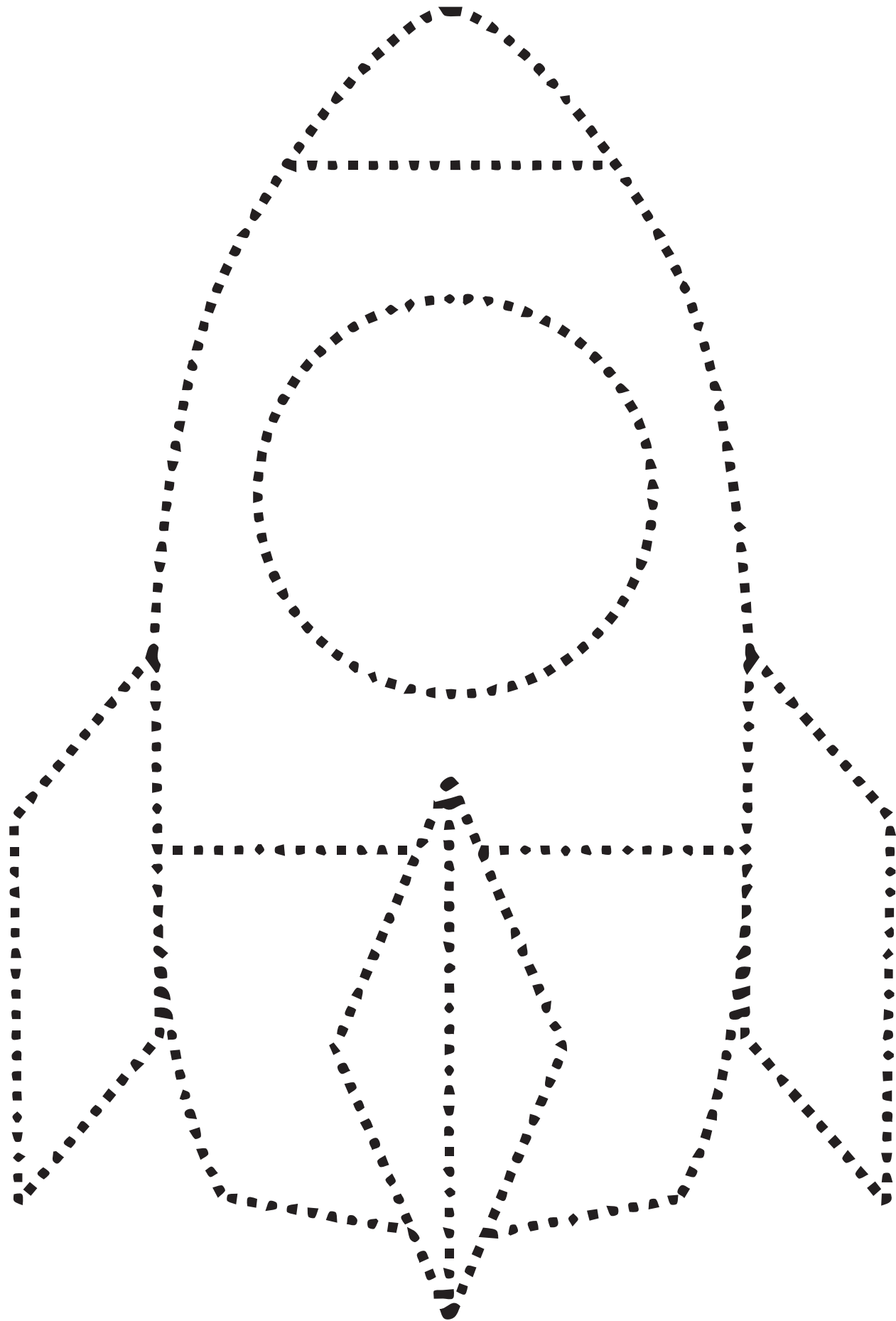

1	[Dashed arch pattern]									
2	[Dashed arch pattern]									
3	[Dashed arch pattern]									
-	[Dashed arch pattern]									
1	[Dashed arch pattern]									
2	[Dashed arch pattern]									
3	[Dashed arch pattern]									
-	[Dashed arch pattern]									
1	[Dashed arch pattern]									
2	[Dashed arch pattern]									
3	[Dashed arch pattern]									
-	[Dashed arch pattern]									
1	[Dashed arch pattern]									
2	[Dashed arch pattern]									
3	[Dashed arch pattern]									

1 2 3 -

1 2 3 -

1 2 3 -

1 2 3 -

1 2 3 -

1 2 3

1	[Dashed arch pattern]											
2	[Dashed arch pattern]											
3	[Dashed arch pattern]											
-	[Empty grid row]											
1	[Dashed arch pattern]											
2	[Dashed arch pattern]											
3	[Dashed arch pattern]											
-	[Empty grid row]											
1	[Dashed arch pattern]											
2	[Dashed arch pattern]											
3	[Dashed arch pattern]											
-	[Empty grid row]											
1	[Dashed arch pattern]											
2	[Dashed arch pattern]											
3	[Dashed arch pattern]											
-	[Empty grid row]											
1	[Dashed arch pattern]											
2	[Dashed arch pattern]											
3	[Dashed arch pattern]											

1	[Dashed cursive 'o' tracing pattern]											
2	[Dashed cursive 'o' tracing pattern]											
3	[Dashed cursive 'o' tracing pattern]											
-	[Dashed cursive 'o' tracing pattern]											
1	[Dashed cursive 'o' tracing pattern]											
2	[Dashed cursive 'o' tracing pattern]											
3	[Dashed cursive 'o' tracing pattern]											
-	[Dashed cursive 'o' tracing pattern]											
1	[Dashed cursive 'o' tracing pattern]											
2	[Dashed cursive 'o' tracing pattern]											
3	[Dashed cursive 'o' tracing pattern]											
-	[Dashed cursive 'o' tracing pattern]											
1	[Dashed cursive 'o' tracing pattern]											
2	[Dashed cursive 'o' tracing pattern]											
3	[Dashed cursive 'o' tracing pattern]											
-	[Dashed cursive 'o' tracing pattern]											
1	[Dashed cursive 'o' tracing pattern]											
2	[Dashed cursive 'o' tracing pattern]											
3	[Dashed cursive 'o' tracing pattern]											

1	[Dashed arch tracing pattern]											
2	[Dashed arch tracing pattern]											
3	[Dashed arch tracing pattern]											
-	[Dashed arch tracing pattern]											
1	[Dashed arch tracing pattern]											
2	[Dashed arch tracing pattern]											
3	[Dashed arch tracing pattern]											
-	[Dashed arch tracing pattern]											
1	[Dashed arch tracing pattern]											
2	[Dashed arch tracing pattern]											
3	[Dashed arch tracing pattern]											
-	[Dashed arch tracing pattern]											
1	[Dashed arch tracing pattern]											
2	[Dashed arch tracing pattern]											
3	[Dashed arch tracing pattern]											
-	[Dashed arch tracing pattern]											
1	[Dashed arch tracing pattern]											
2	[Dashed arch tracing pattern]											
3	[Dashed arch tracing pattern]											

1
2
3
-

1
2
3
-

1
2
3
-

1
2
3
-

1
2
3
-

1
2
3

1	[Dashed wave pattern]											
2	[Dashed wave pattern]											
3	[Dashed wave pattern]											
-	[Dashed wave pattern]											
1	[Dashed wave pattern]											
2	[Dashed wave pattern]											
3	[Dashed wave pattern]											
-	[Dashed wave pattern]											
1	[Dashed wave pattern]											
2	[Dashed wave pattern]											
3	[Dashed wave pattern]											
-	[Dashed wave pattern]											
1	[Dashed wave pattern]											
2	[Dashed wave pattern]											
3	[Dashed wave pattern]											

1 2 3 -

1 2 3 -

1 2 3 -

1 2 3 -

1 2 3 -

1 2 3 -

1 2 3 -

1 2 3 -

1 2 3 -

1	[Dashed uppercase letter 'U' for tracing]												
2	[Dashed uppercase letter 'U' for tracing]												
3	[Empty grid for independent practice]												
-	[Empty grid for independent practice]												
1	[Dashed uppercase letter 'U' for tracing]												
2	[Dashed uppercase letter 'U' for tracing]												
3	[Empty grid for independent practice]												
-	[Empty grid for independent practice]												
1	[Dashed uppercase letter 'U' for tracing]												
2	[Dashed uppercase letter 'U' for tracing]												
3	[Empty grid for independent practice]												
-	[Empty grid for independent practice]												
1	[Dashed uppercase letter 'U' for tracing]												
2	[Dashed uppercase letter 'U' for tracing]												
3	[Empty grid for independent practice]												
-	[Empty grid for independent practice]												
1	[Dashed uppercase letter 'U' for tracing]												
2	[Dashed uppercase letter 'U' for tracing]												
3	[Empty grid for independent practice]												

1																			
2																			
3																			
-																			
1																			
2																			
3																			
-																			
1																			
2																			
3																			
-																			
1																			
2																			
3																			
-																			
1																			
2																			
3																			

1	U	U	U	U	U	U	U	U	U	U
2	U	U	U	U	U	U	U	U	U	U
3										
-										
1	U	U	U	U	U	U	U	U	U	U
2	U	U	U	U	U	U	U	U	U	U
3										
-										
1	U	U	U	U	U	U	U	U	U	U
2	U	U	U	U	U	U	U	U	U	U
3										
-										
1	U	U	U	U	U	U	U	U	U	U
2	U	U	U	U	U	U	U	U	U	U
3										
-										
1	U	U	U	U	U	U	U	U	U	U
2	U	U	U	U	U	U	U	U	U	U
3										

1	[Dashed zigzag line]												
2	[Dashed zigzag line]												
3	[Dashed zigzag line]												
-													
1	[Dashed zigzag line]												
2	[Dashed zigzag line]												
3	[Dashed zigzag line]												
-													
1	[Dashed zigzag line]												
2	[Dashed zigzag line]												
3	[Dashed zigzag line]												
-													
1	[Dashed zigzag line]												
2	[Dashed zigzag line]												
3	[Dashed zigzag line]												
-													
1	[Dashed zigzag line]												
2	[Dashed zigzag line]												
3	[Dashed zigzag line]												

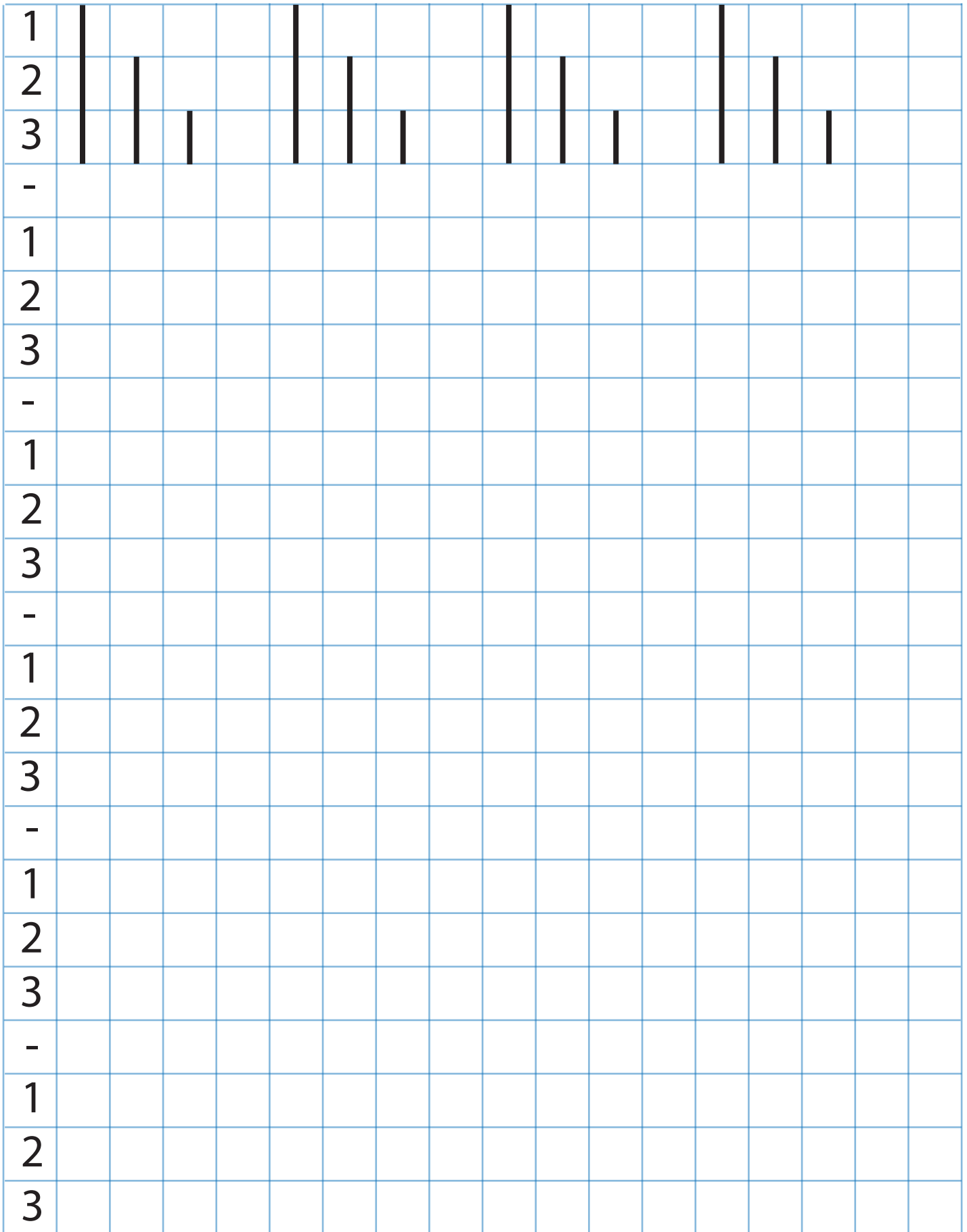

1														
2														
3														
-														
1														
2														
3														
-														
1														
2														
3														
-														
1														
2														
3														
-														
1														
2														
3														

1		○	—	○	—	○	—	○	—
2	—	○	—	○	—	○	—	○	—
3									
-									
1									
2									
3									
-									
1									
2									
3									
-									
1									
2									
3									
-									
1									
2									
3									

1																			
2	o	o		o	o		o	o		o	o		o	o					
3																			
-																			
1																			
2																			
3																			
-																			
1																			
2																			
3																			
-																			
1																			
2																			
3																			
-																			
1																			
2																			
3																			

1	C C C C C											
2	C C C C C											
3												
-												
1												
2												
3												
-												
1												
2												
3												
-												
1												
2												
3												
-												
1												
2												
3												

1	D D D D D										
2											
3											
-											
1											
2											
3											
-											
1											
2											
3											
-											
1											
2											
3											
-											
1											
2											
3											

1				ا		ح				ا		ح				ا		ح				ا		ح				
2																												
3																												
-																												
1																												
2																												
3																												
-																												
1																												
2																												
3																												
-																												
1																												
2																												
3																												

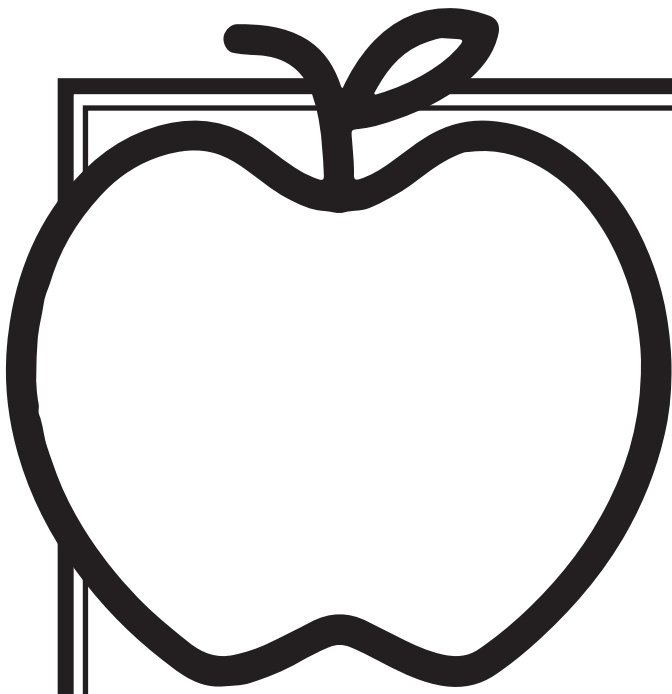

manzana

Rojo



www.materialparamaestros.com

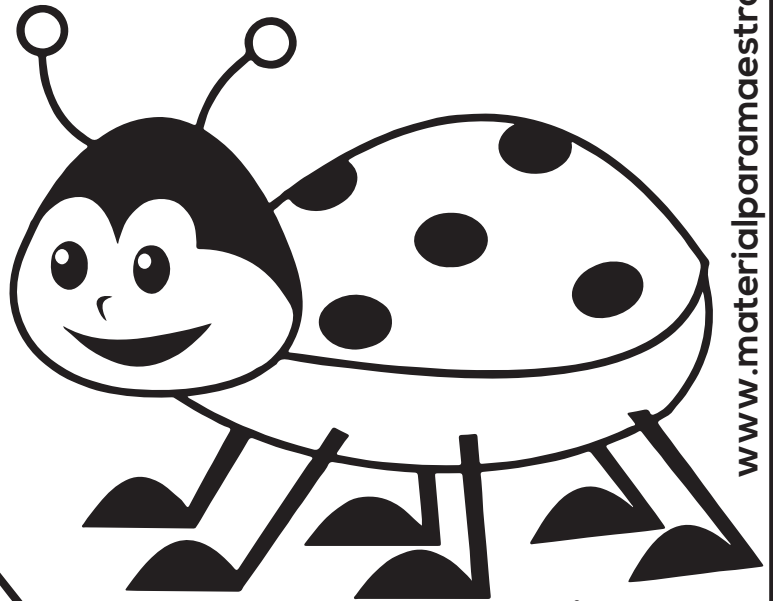

catarina

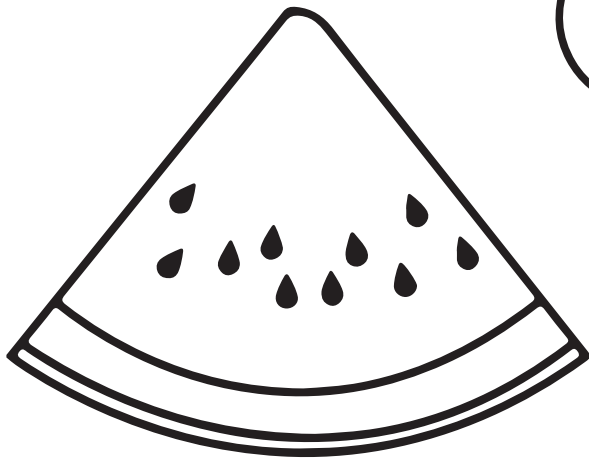

sandia

fresa



corazones

Verde

MATERIAL
PARA MAESTROS

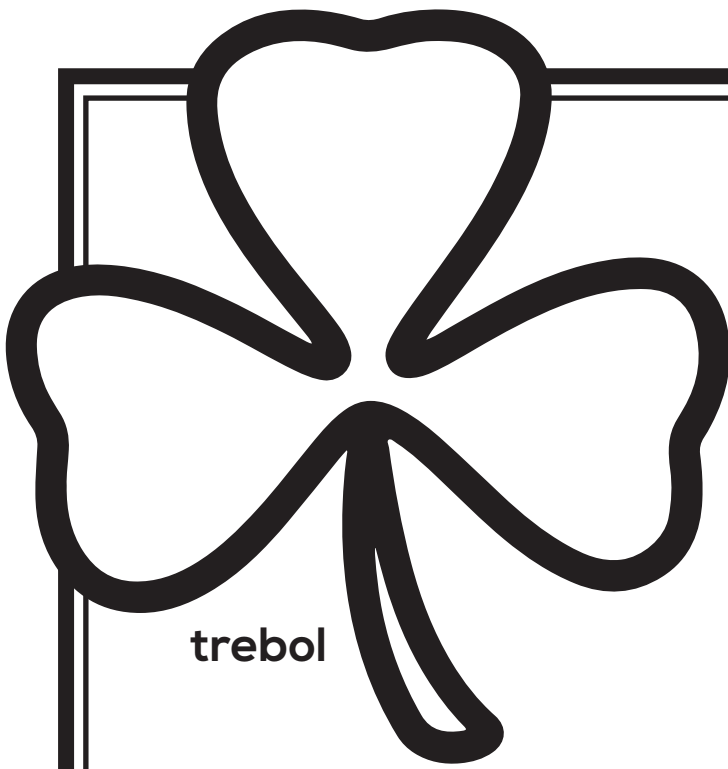

trebol



cactus



hoja

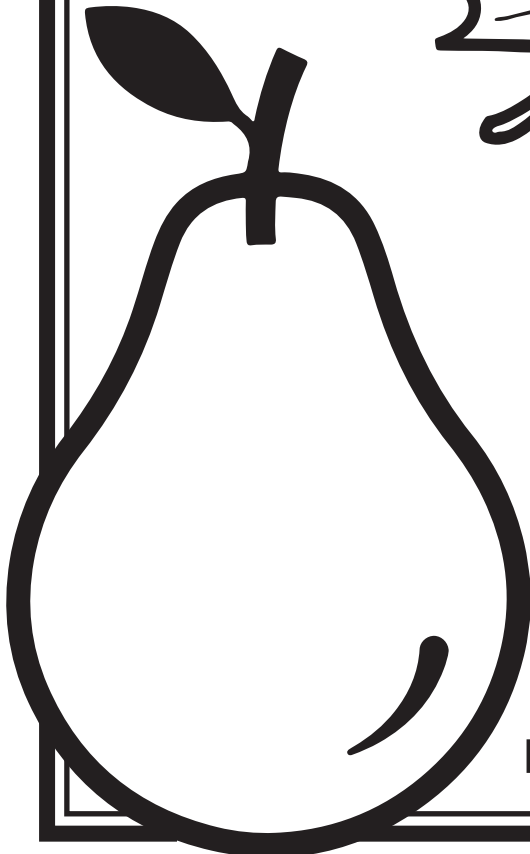

pera

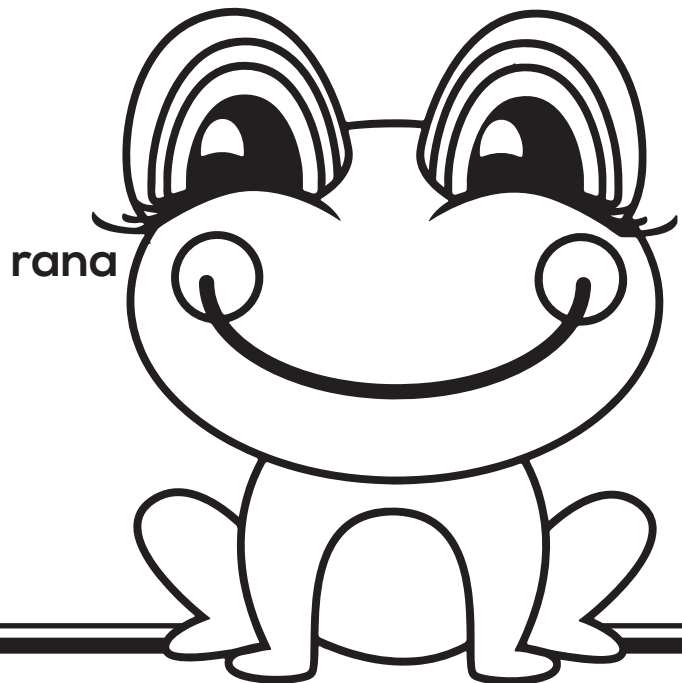

rana

Azul

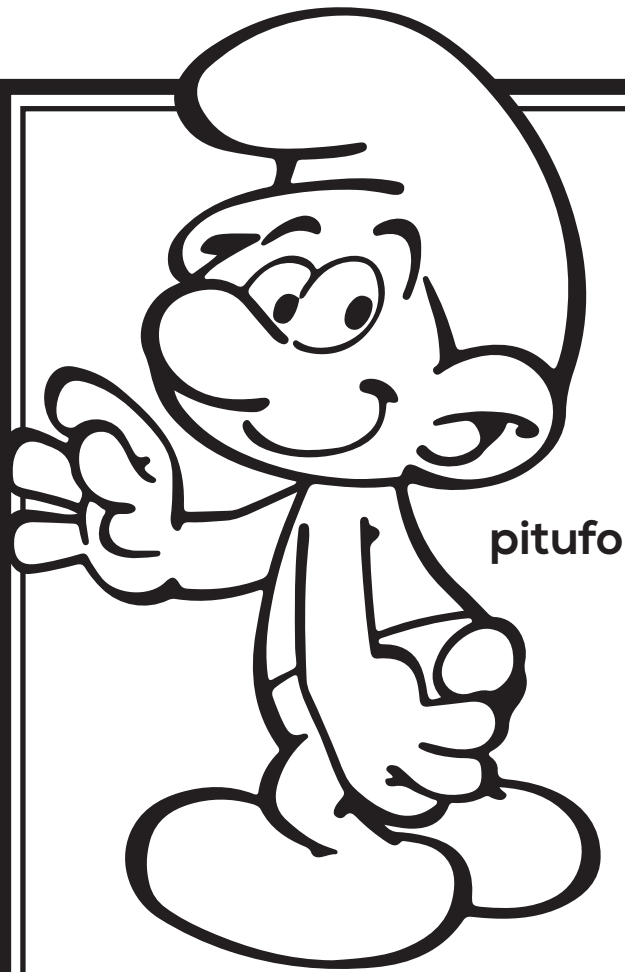

pitufu

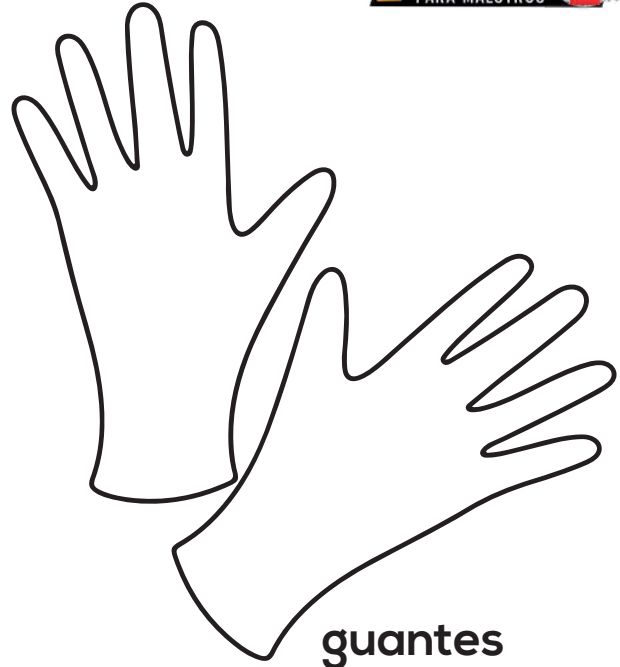

guantes

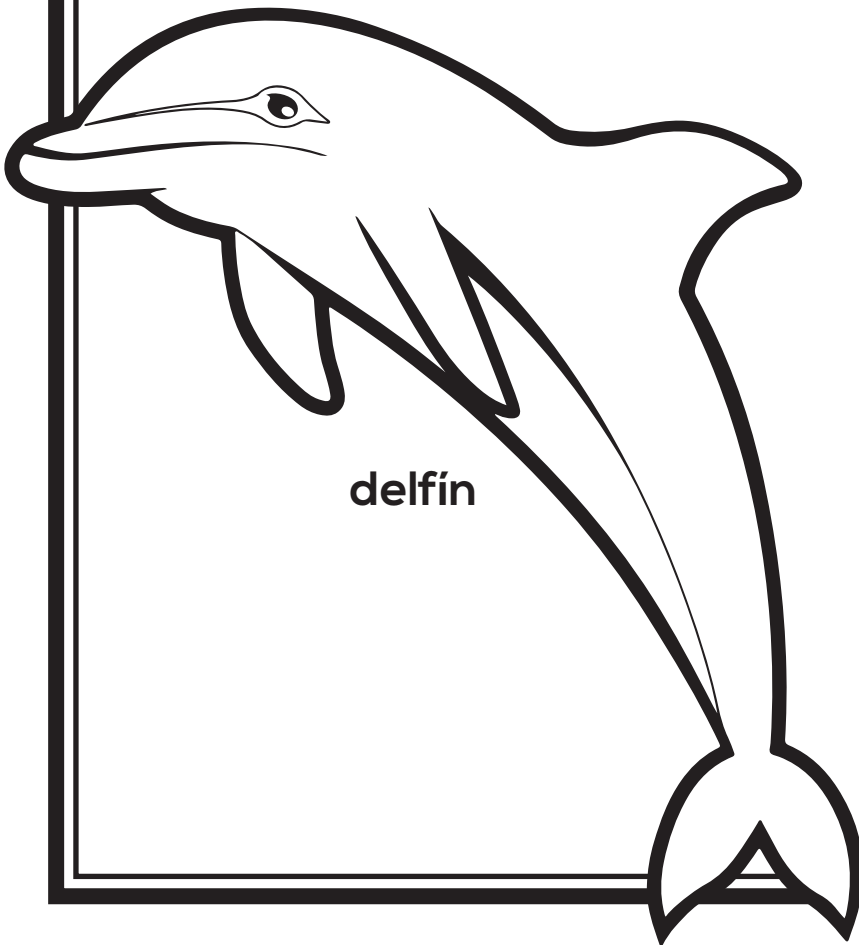

delfín

gotas



Naranja



zanahoria



balón



calabaza

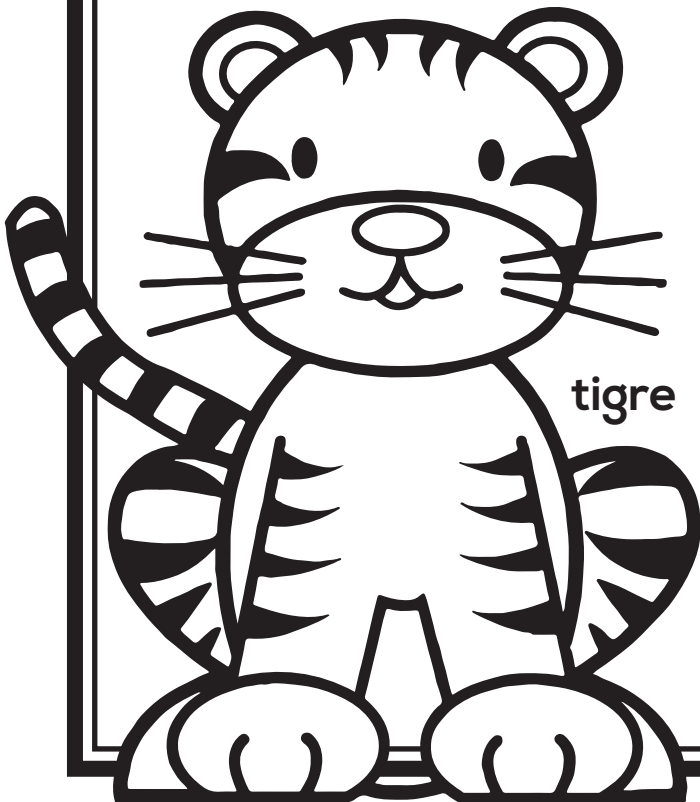

tigre

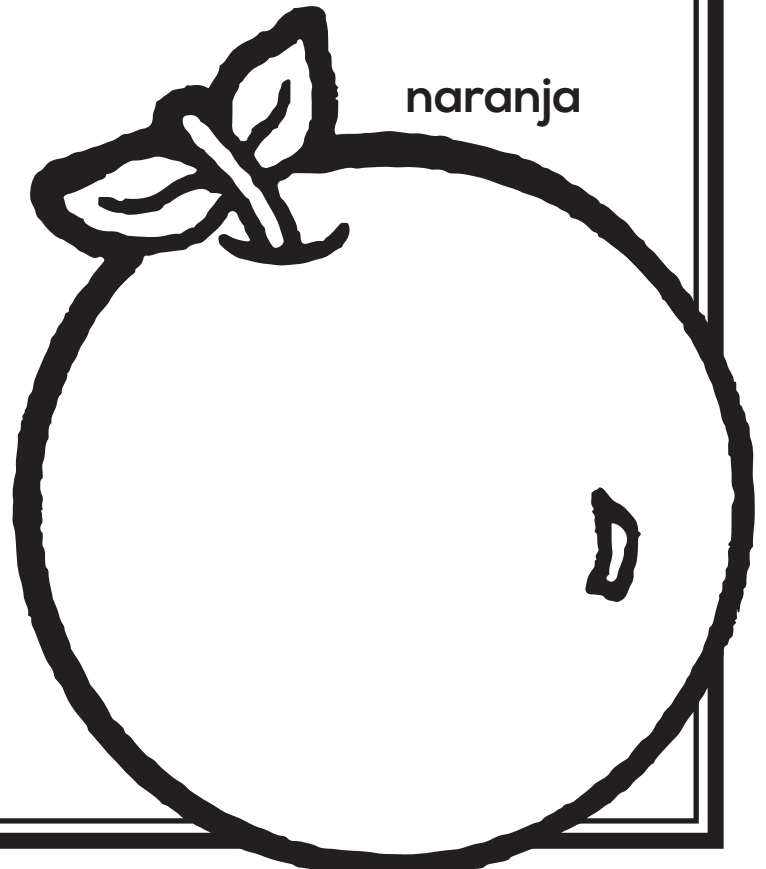

naranja

Café

MATERIAL PARA MAESTROS

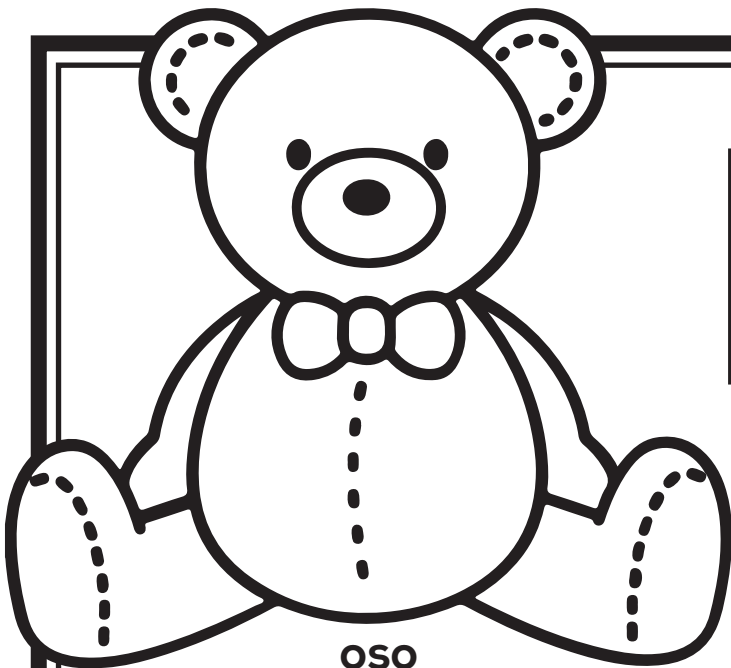

oso

chocolate



madera



silla

botas



Morado

MATERIAL
PARA MAESTROS

uvas



berengena

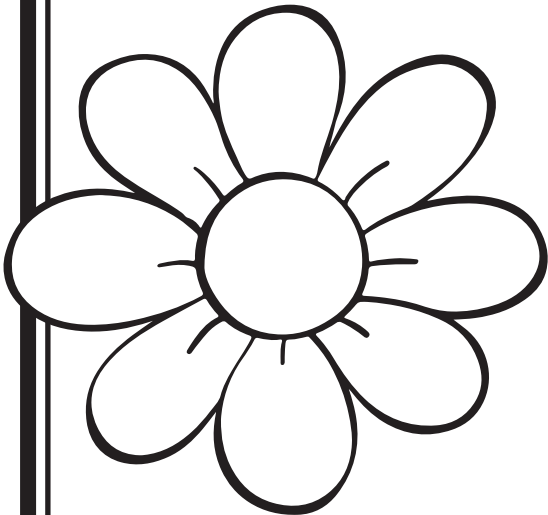

flor

pulpo

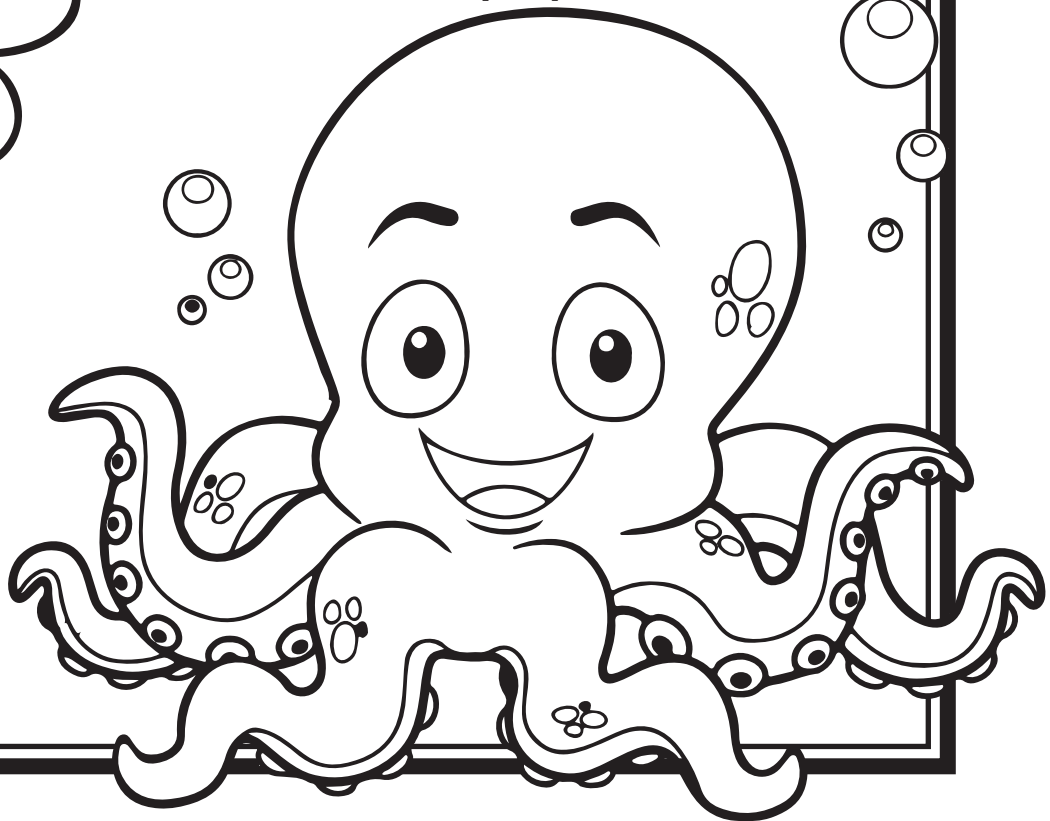

Rosa

MATERIAL
PARA MAESTROS



tacones



moño

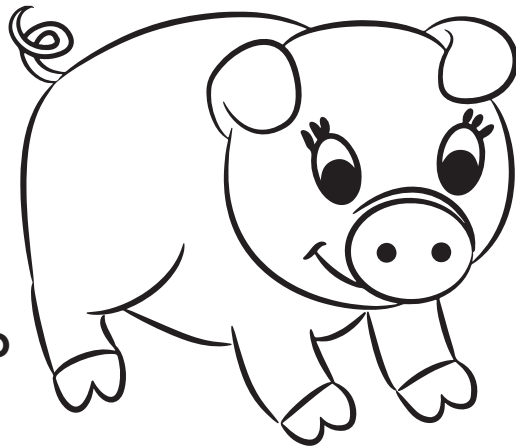

cerdo

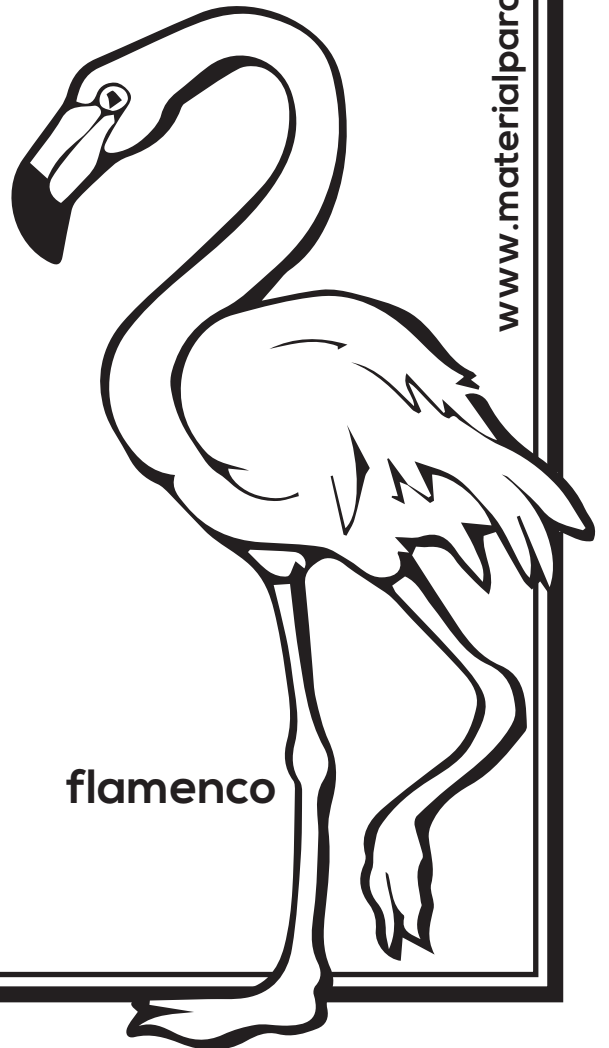

flamenco

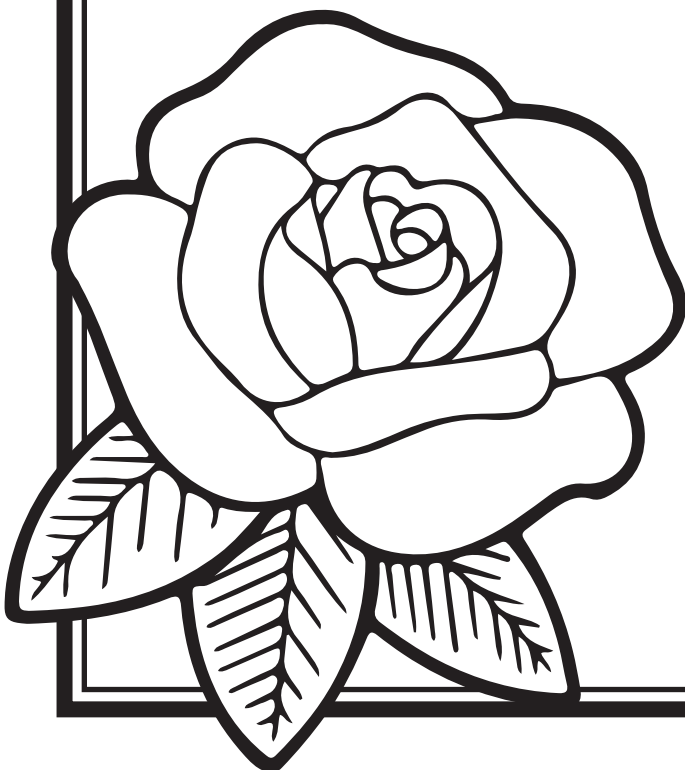

rosa

Amarillo

MATERIAL
PARA MAESTROS

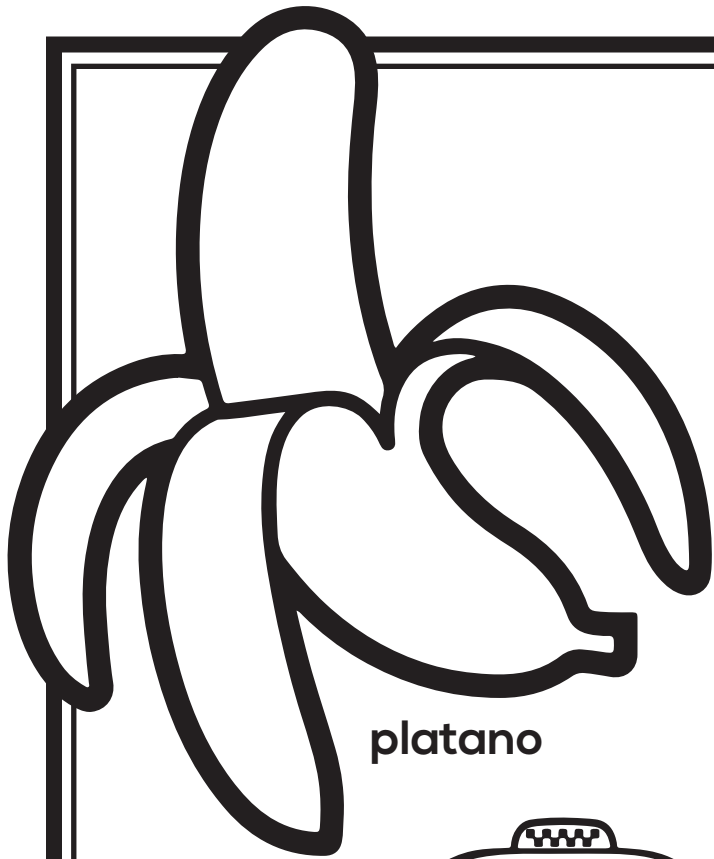

platano

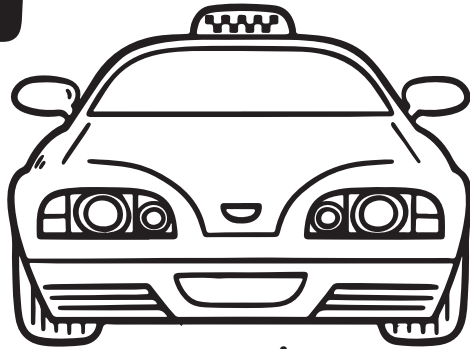

taxi

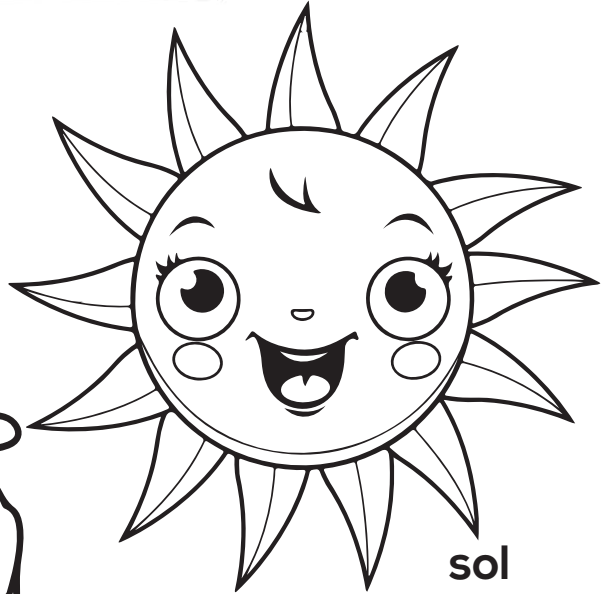

sol

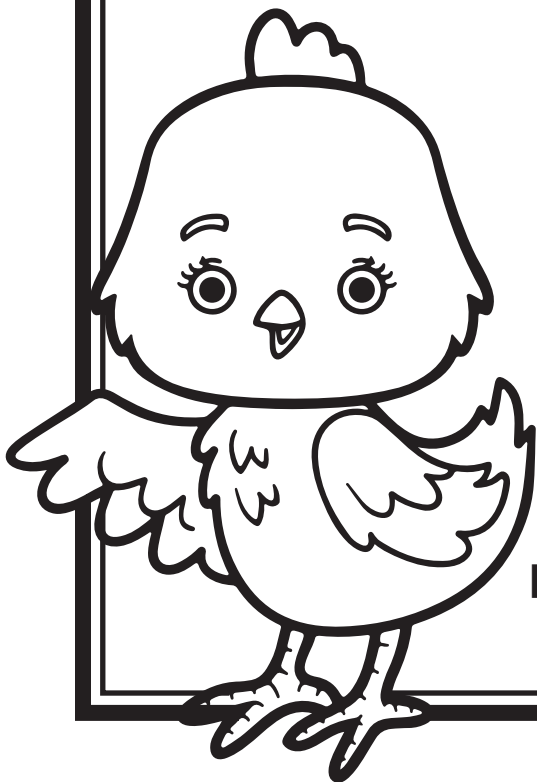

pollito

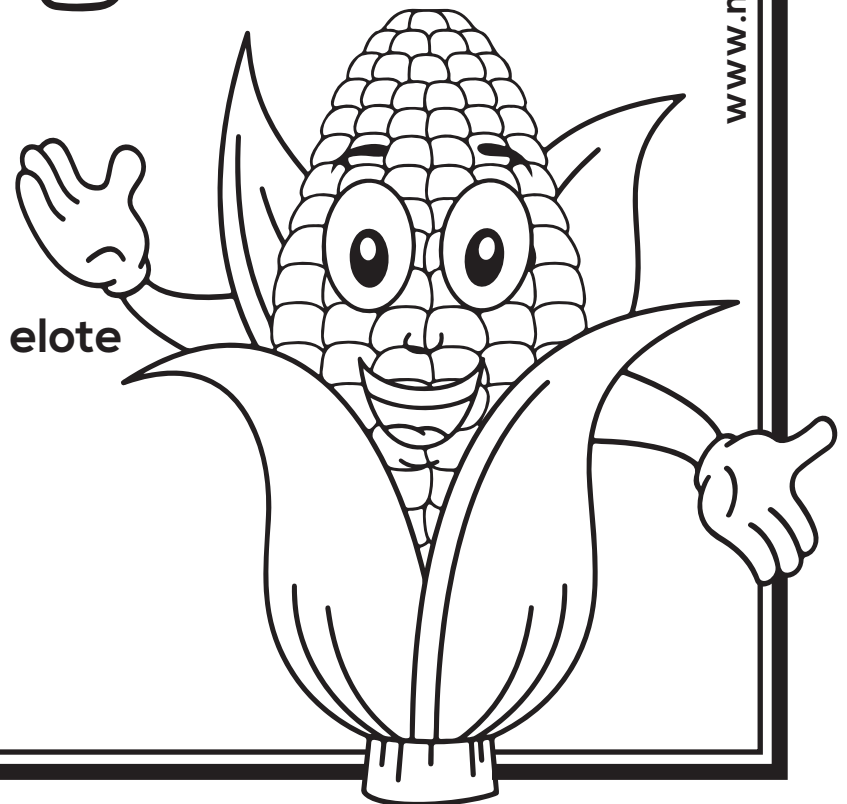

elote

Blanco

MATERIAL
PARA MAESTROS



nieve

ajo

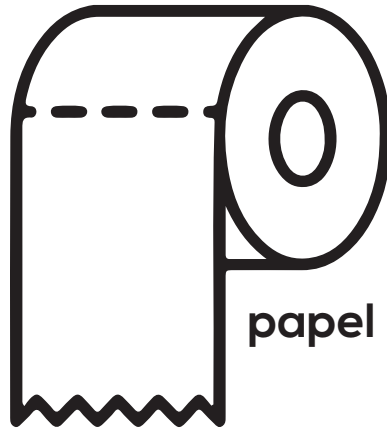
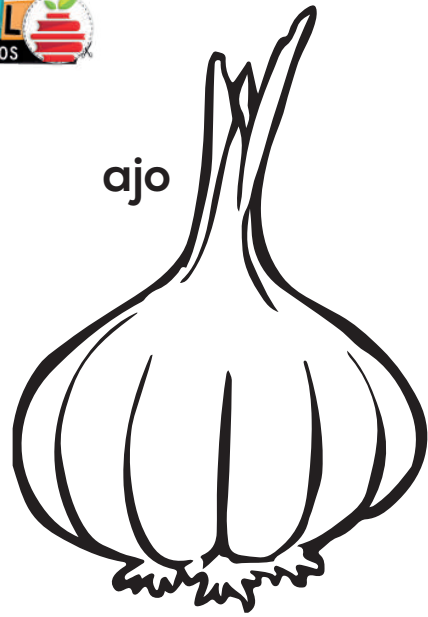

papel

www.materialparamaestros.com

concha



diente

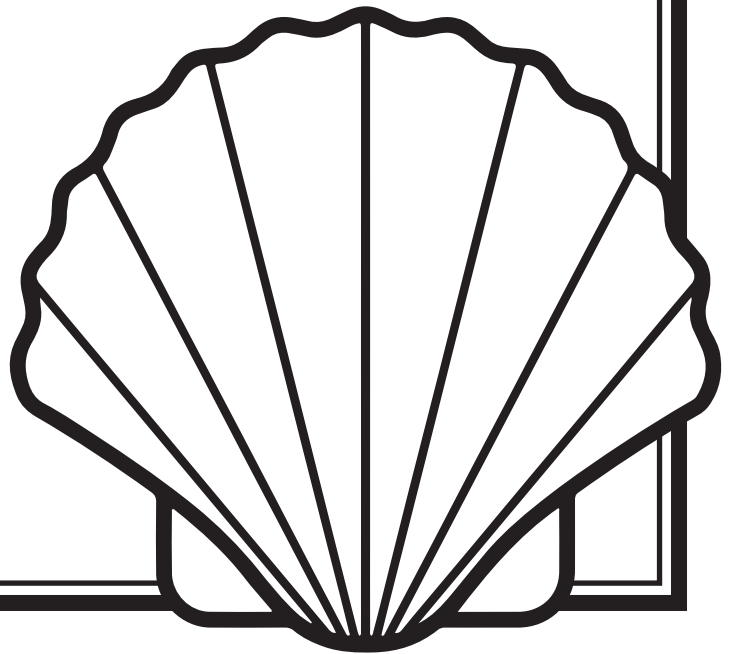

Negro



mochila

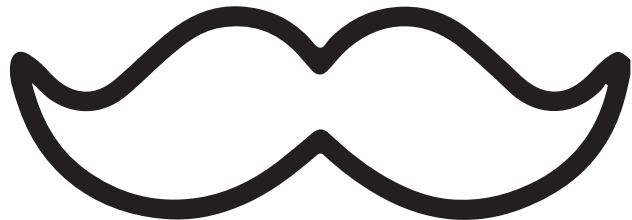

bigote



muerciélago

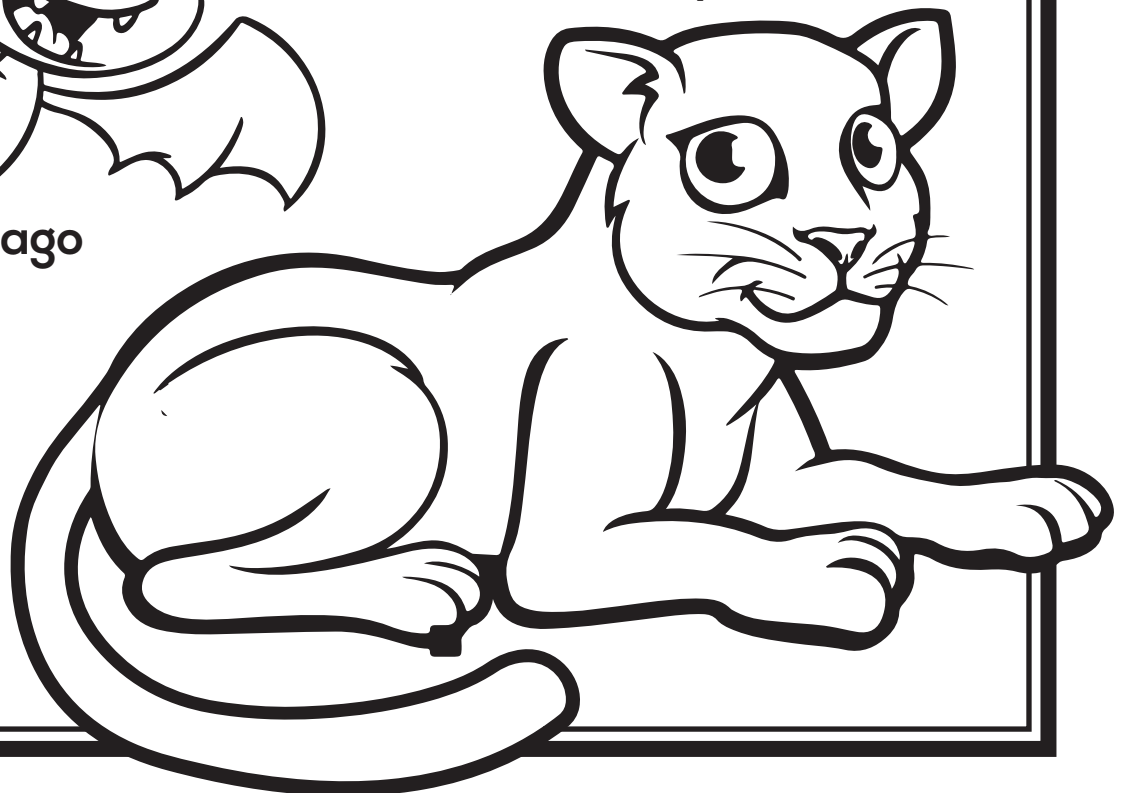

puma

Triángulo

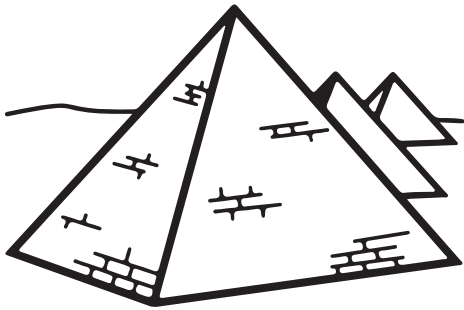
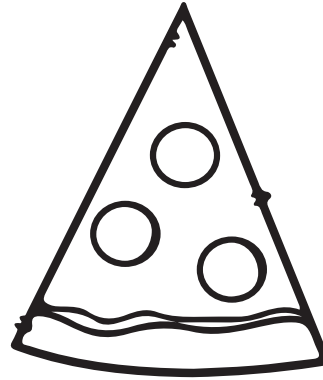
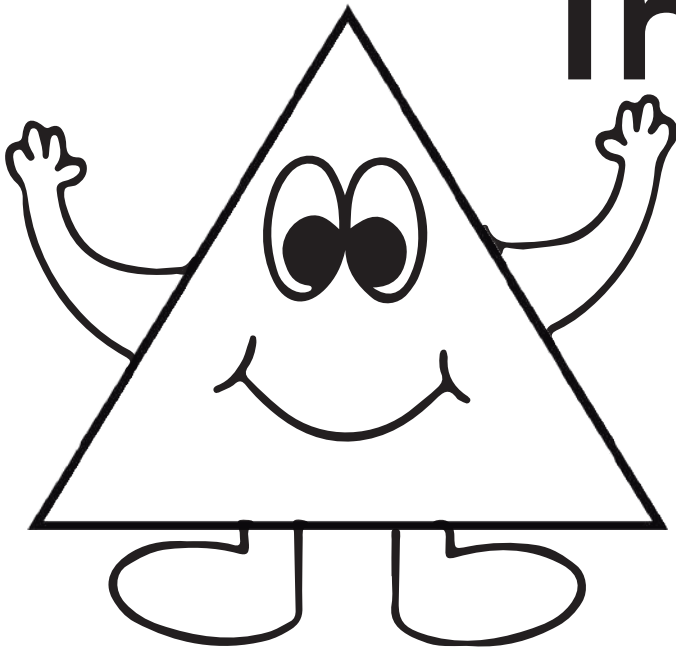

Remarca por la línea punteada.

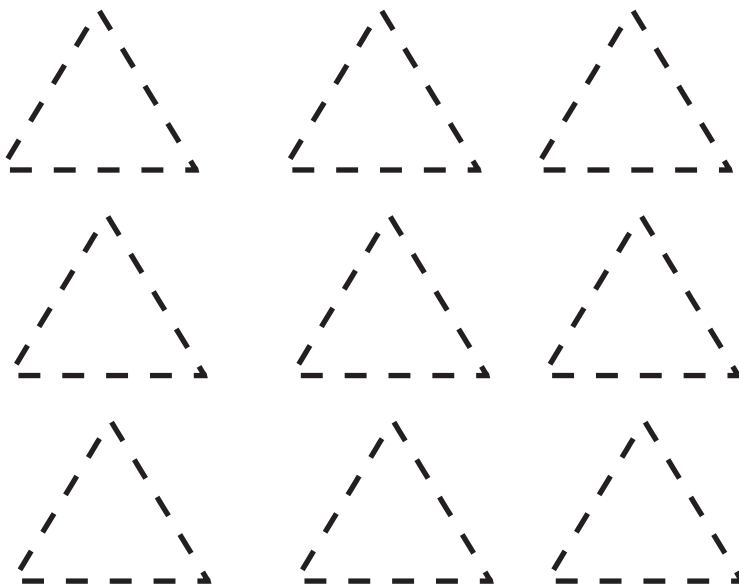

Dibuja un triángulo.

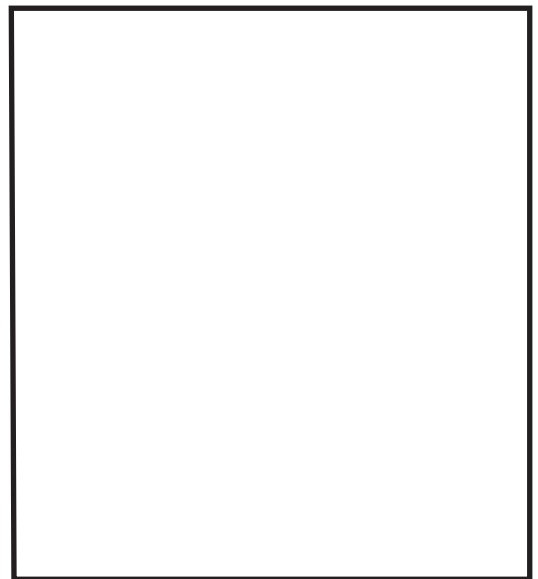

Círculo

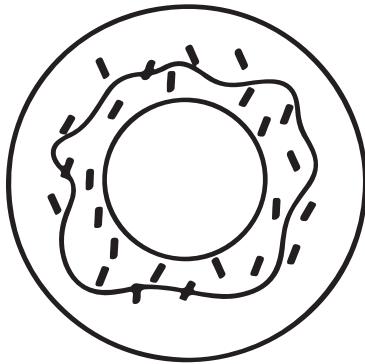
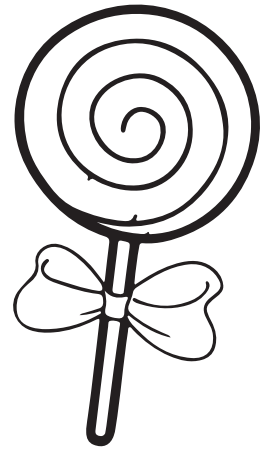
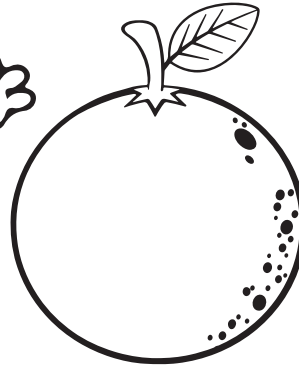

Remarca por la línea punteada.

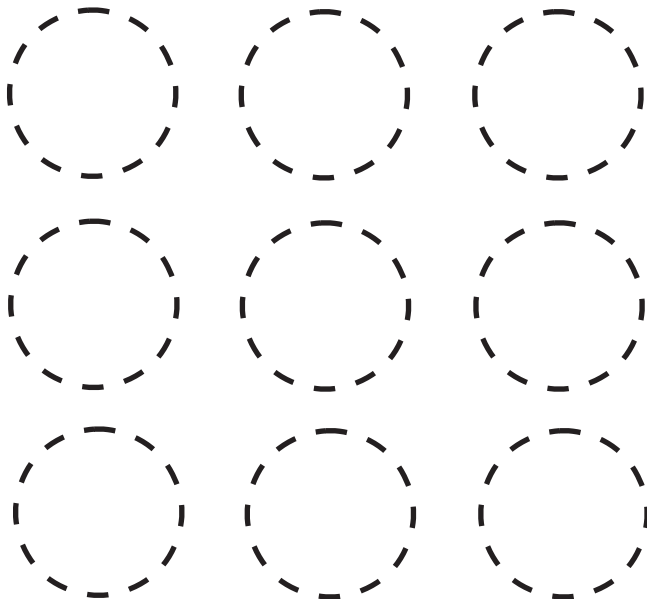

Dibuja un círculo.

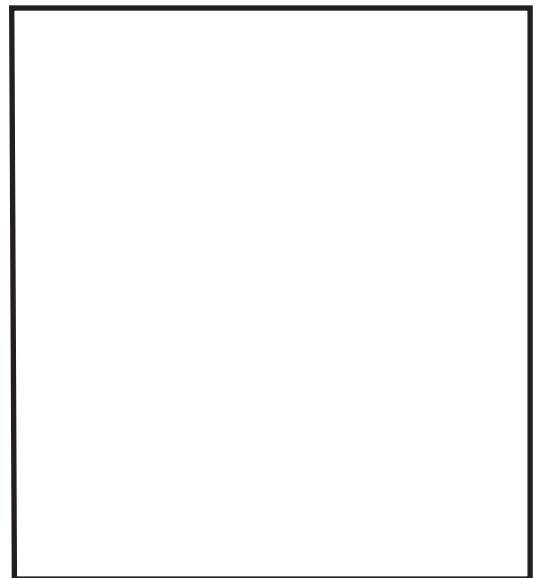

Cuadrado

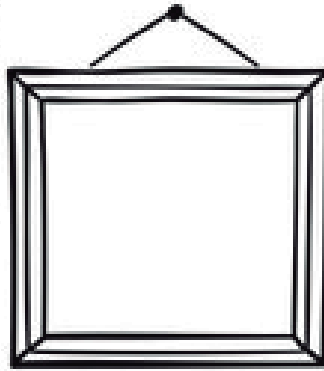
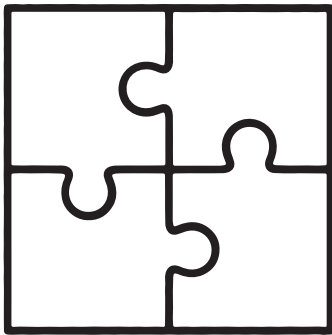
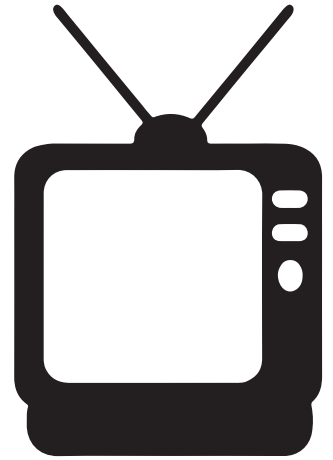
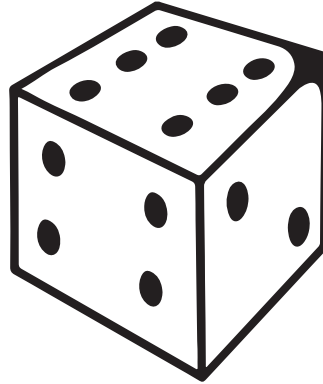
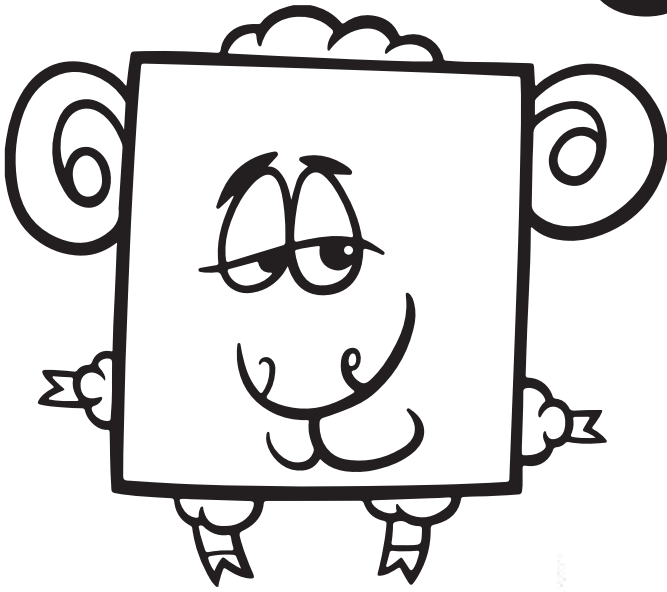

Remarca por la línea punteada.

Dibuja un cuadrado.

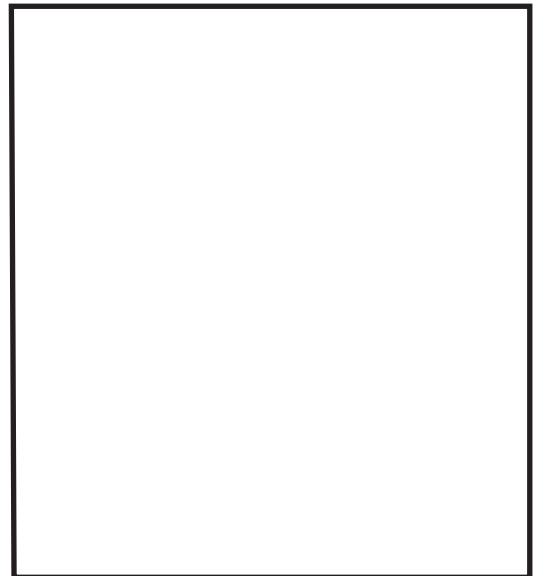
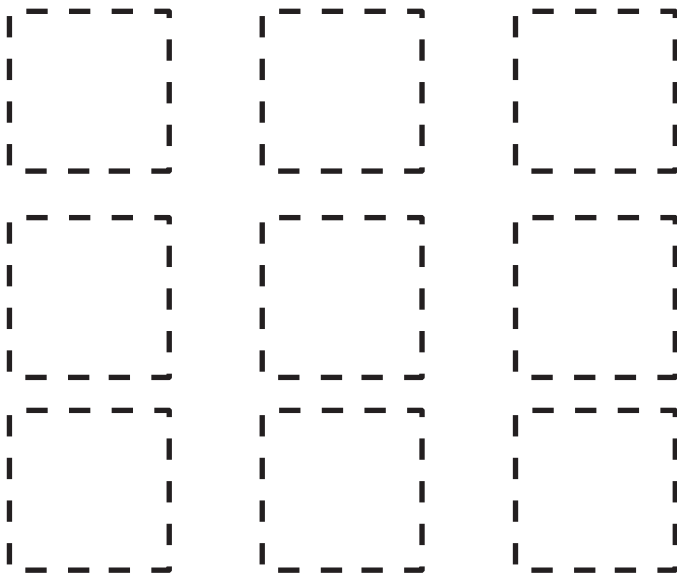

Rectángulo

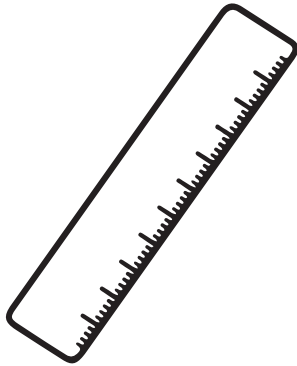
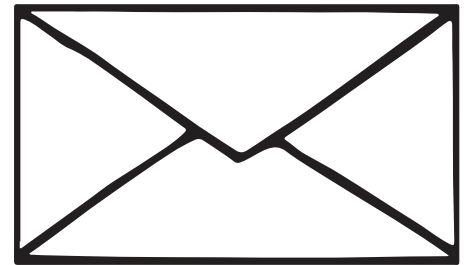
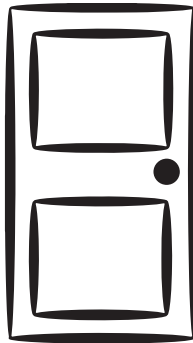
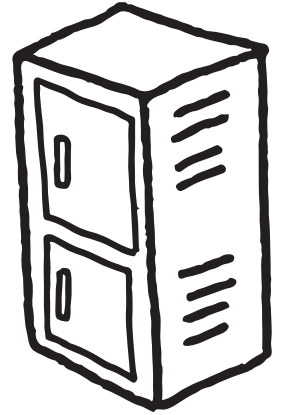
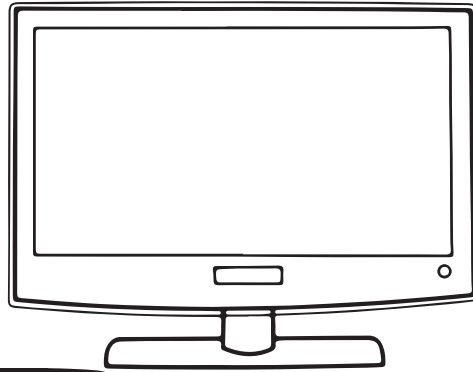
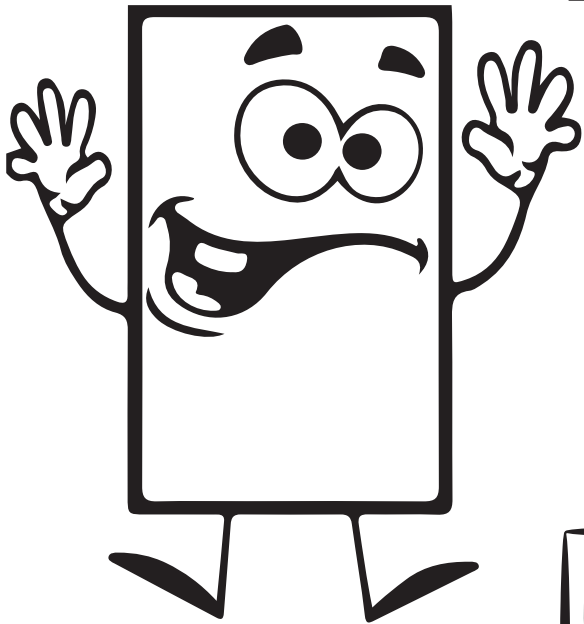

Remarca por la línea punteada.

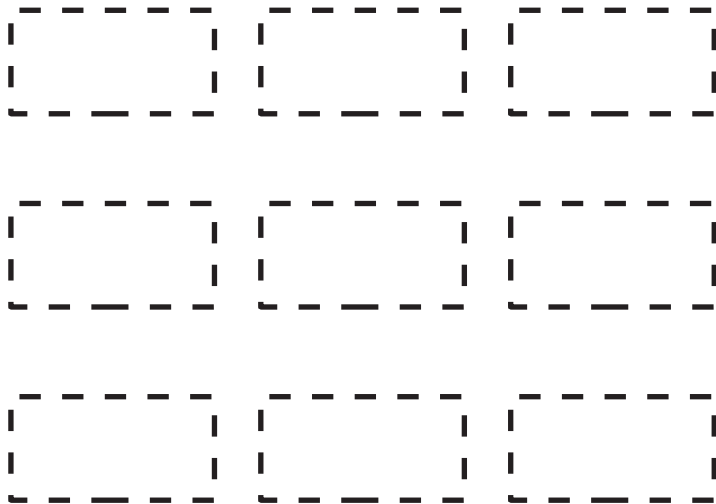

Dibuja un rectángulo.

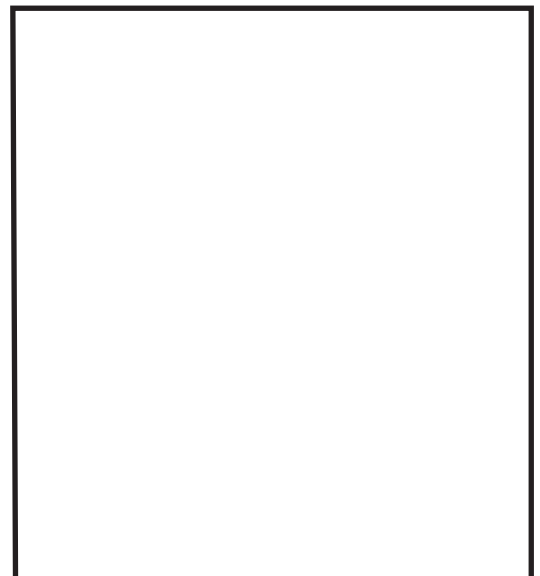

Rombo

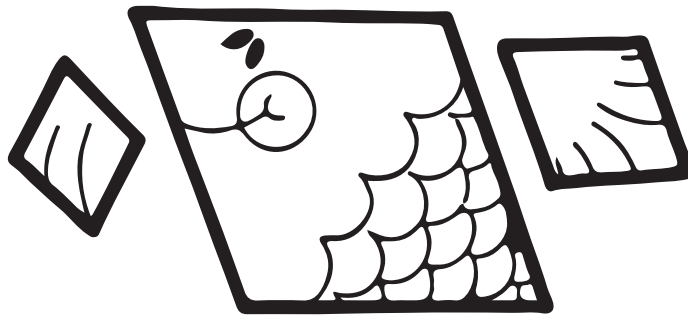
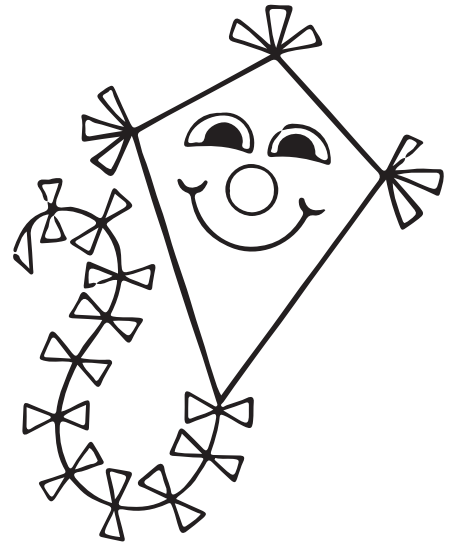
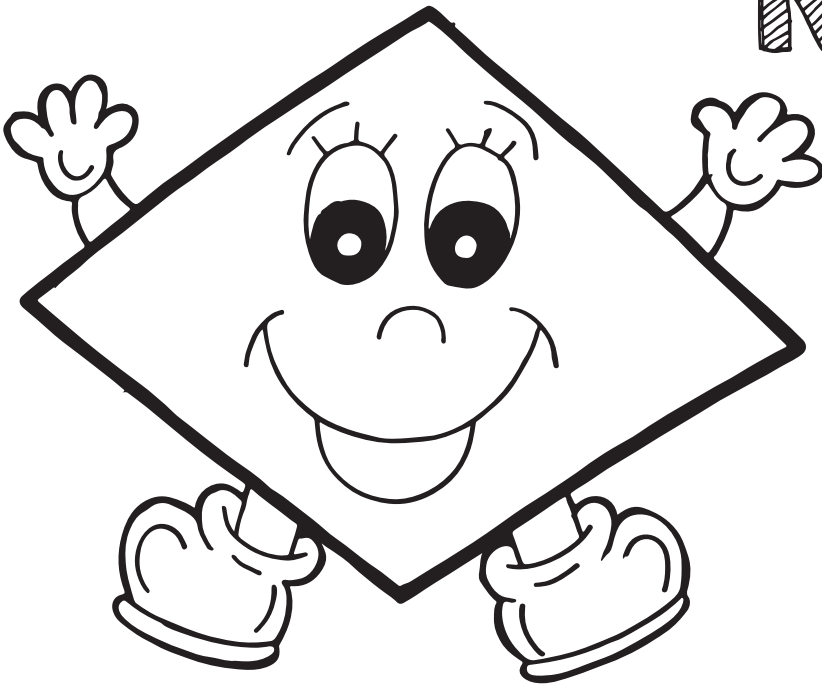

Remarca por la línea punteada.

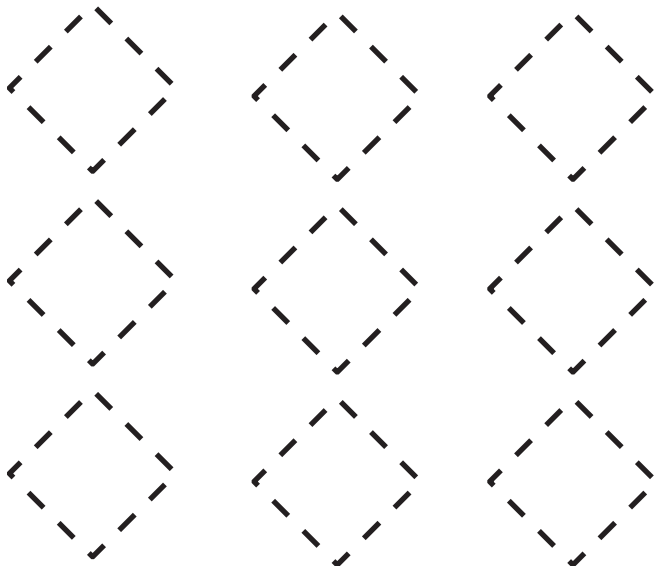

Dibuja un rombo.

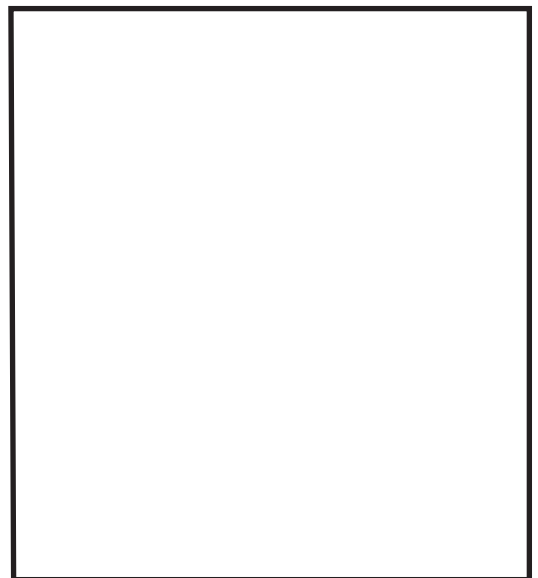

Trapepecio

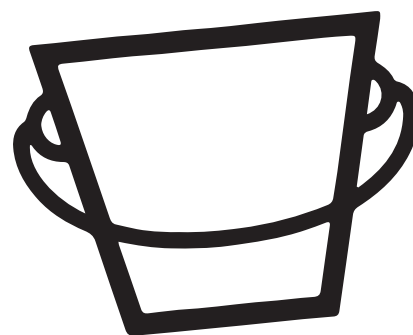
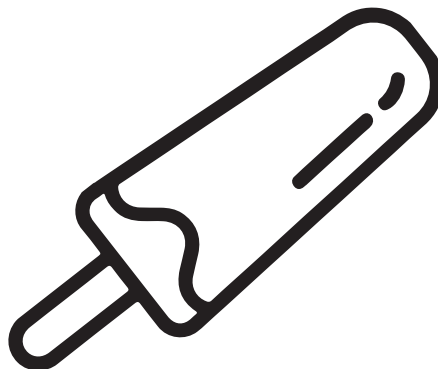
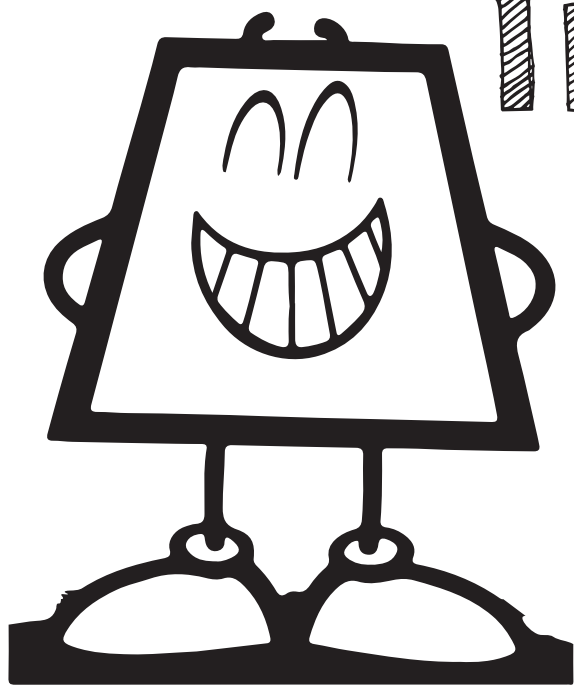

Remarca por la linea punteada.

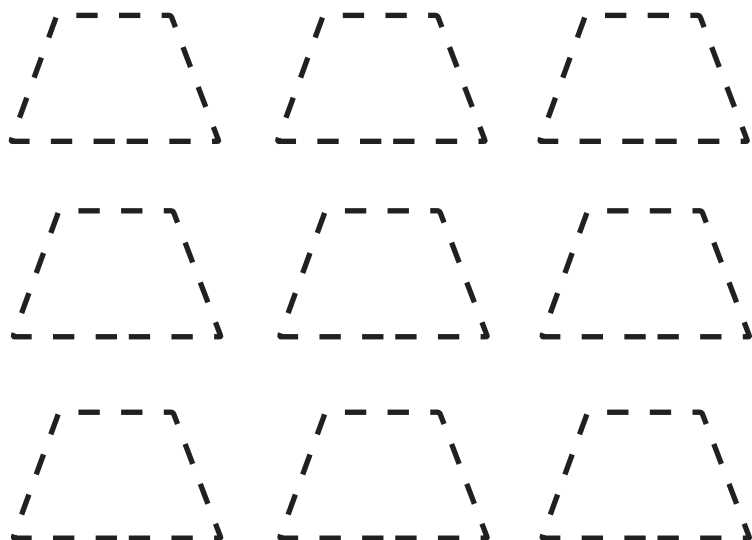

Dibuja un trapepecio.

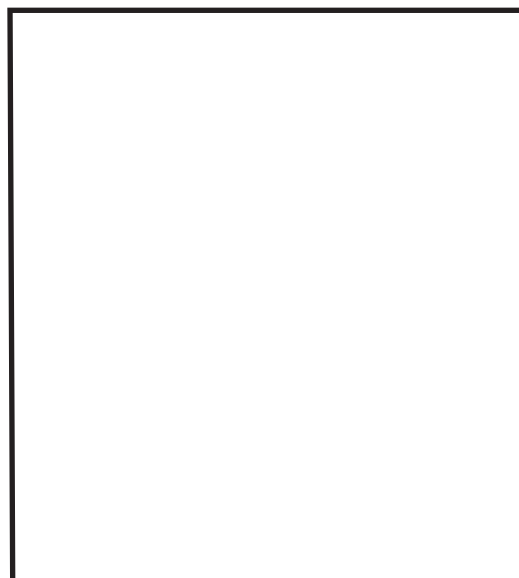

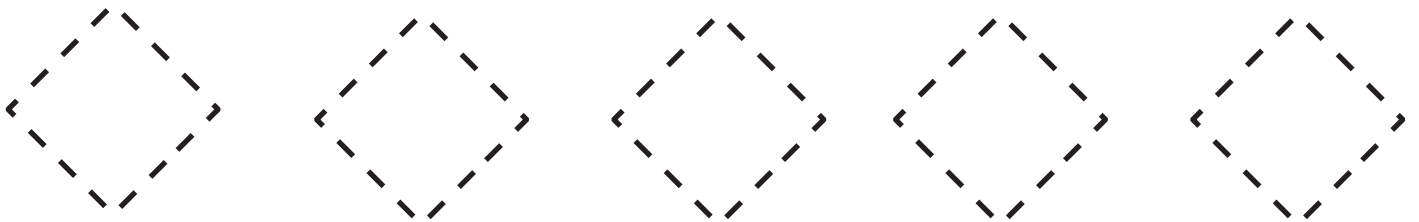
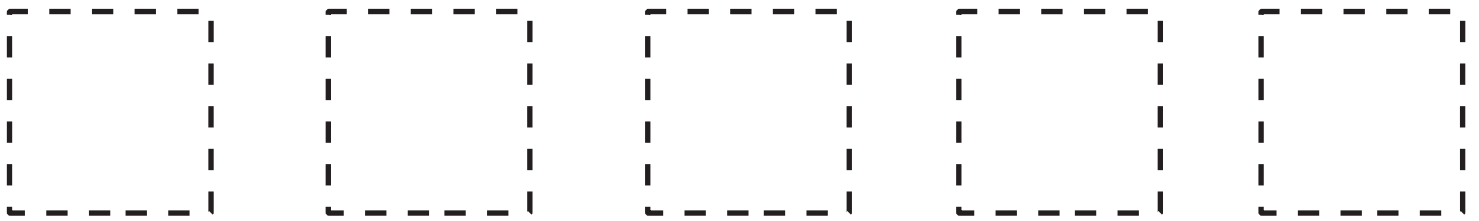
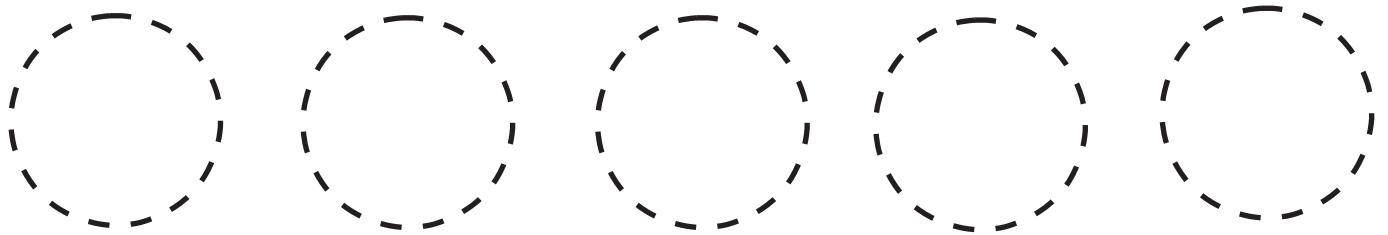
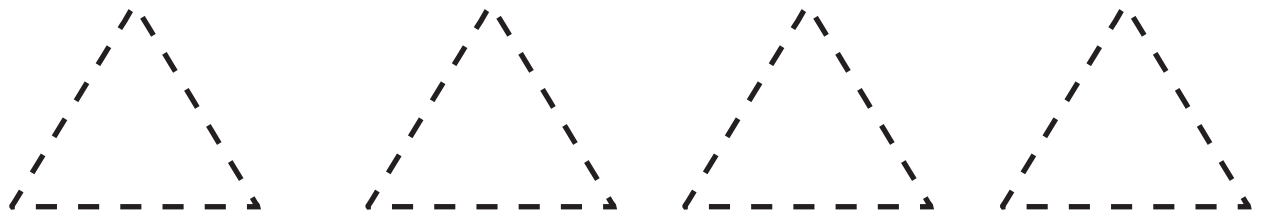

Los 5 sentidos

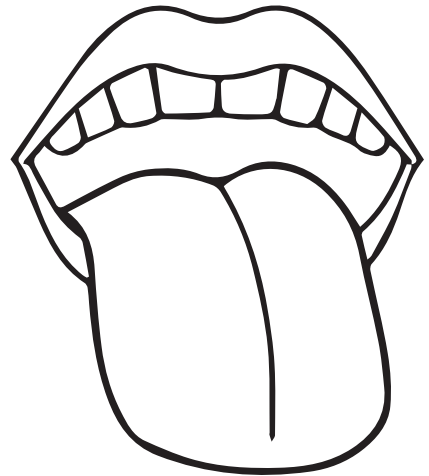
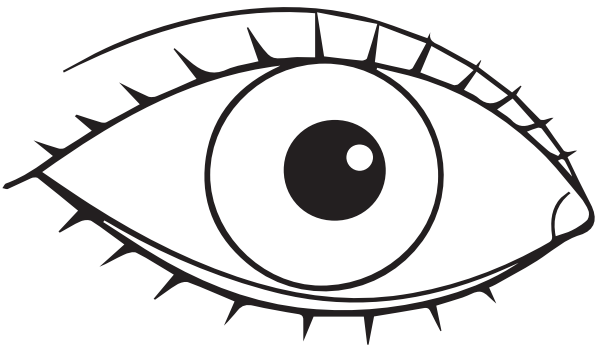
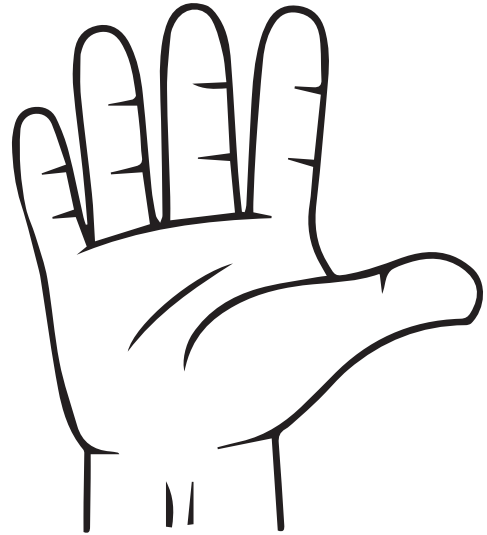

olfato

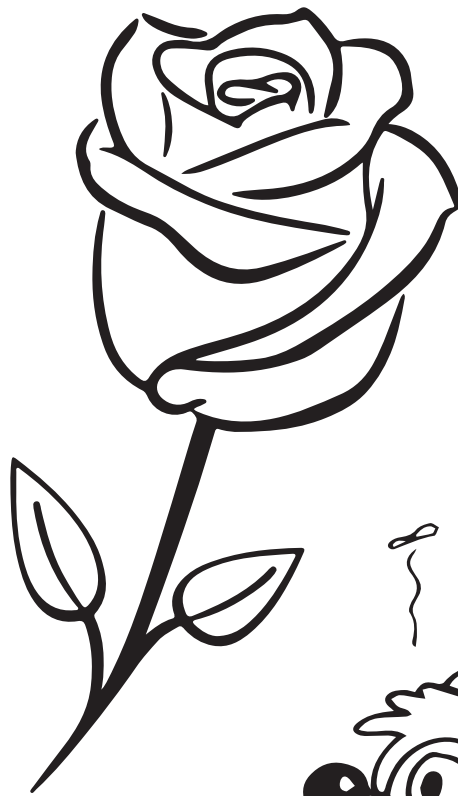

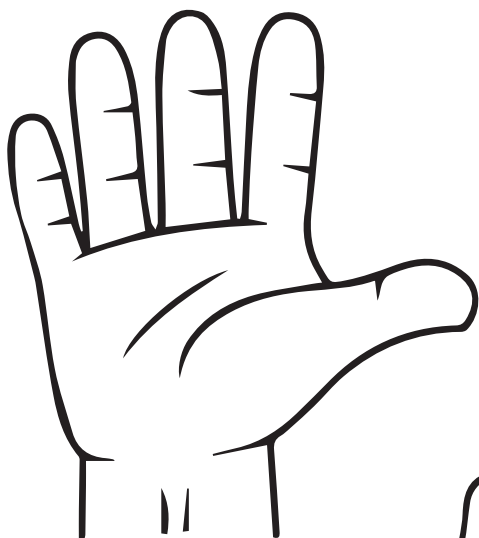

tacto



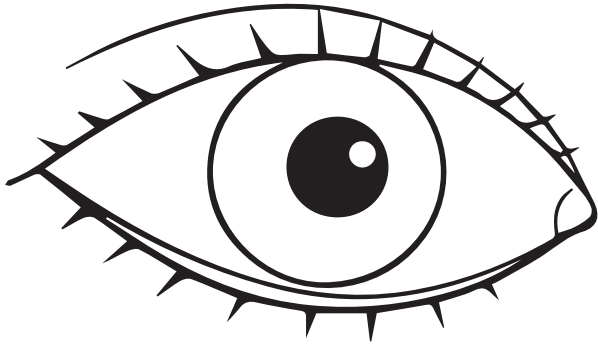

vista

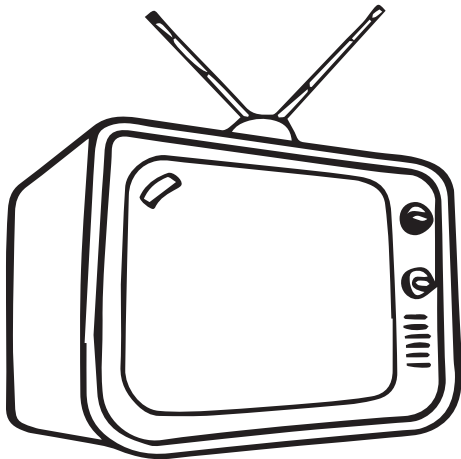

gusto

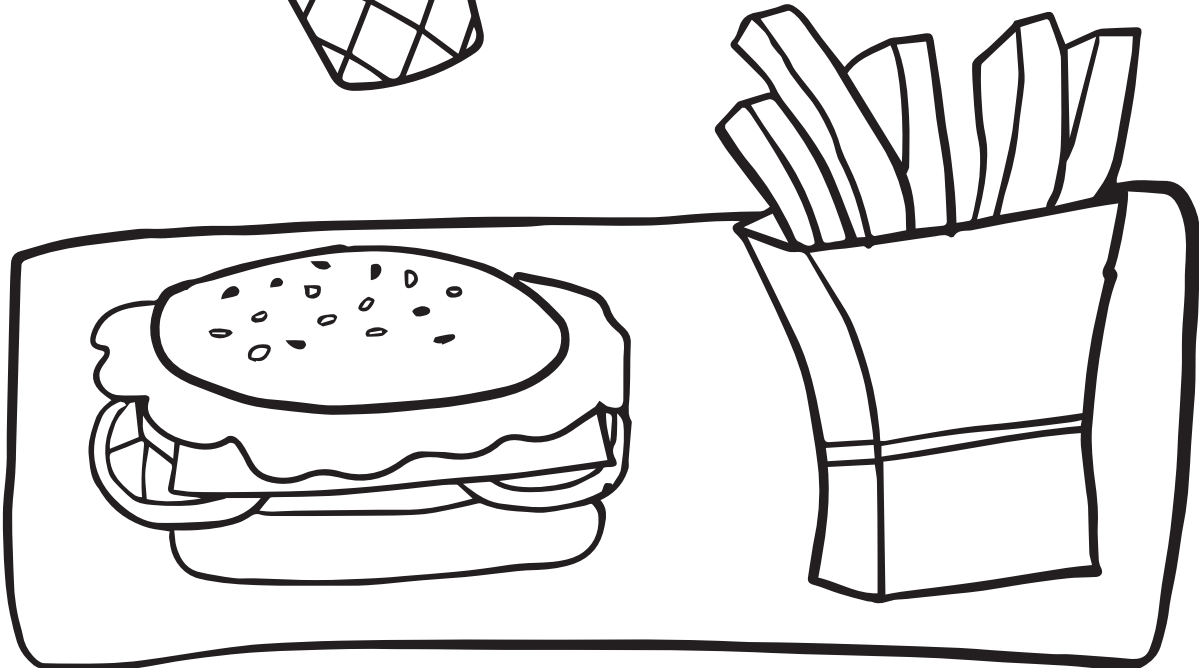
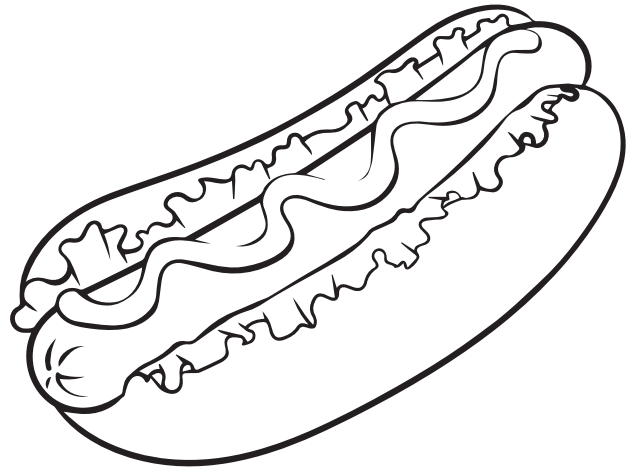
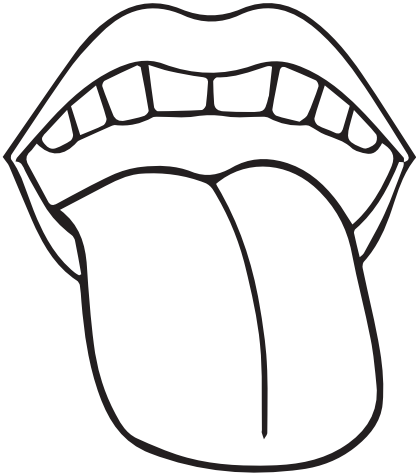



oído

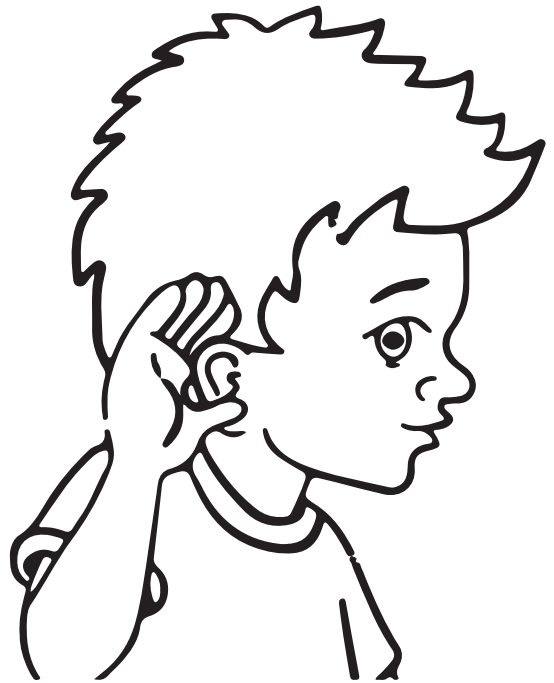
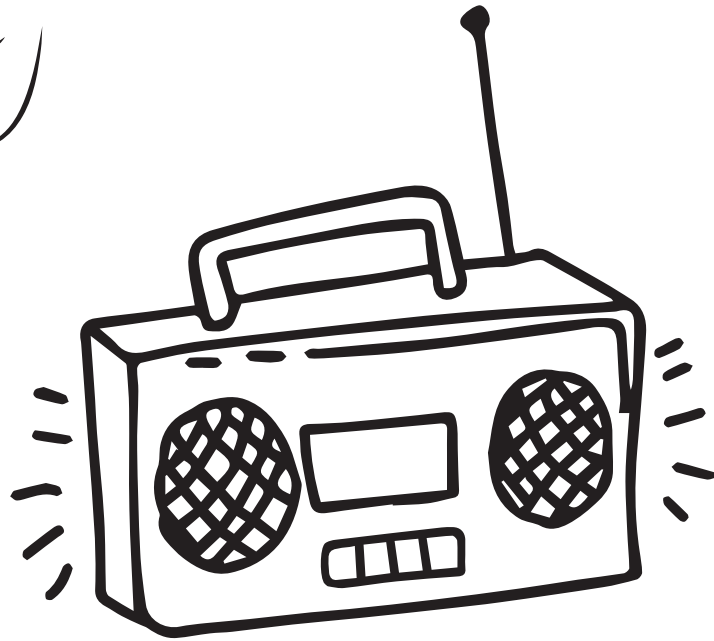

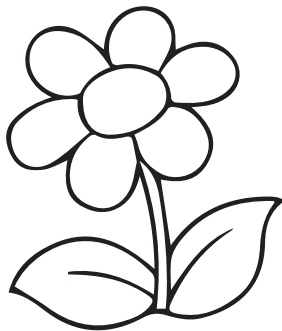
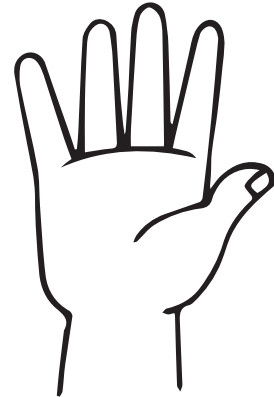
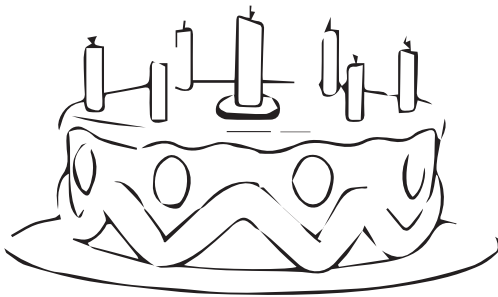
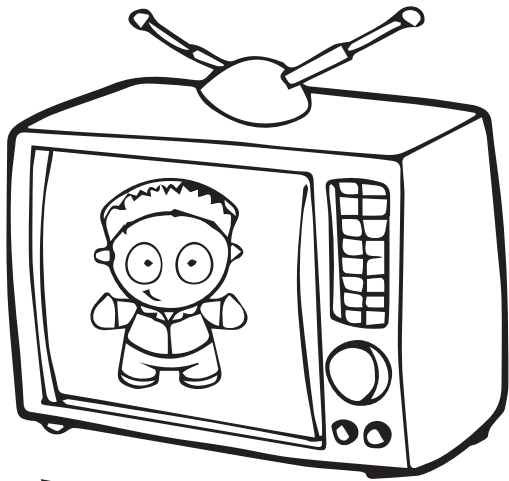

Uno

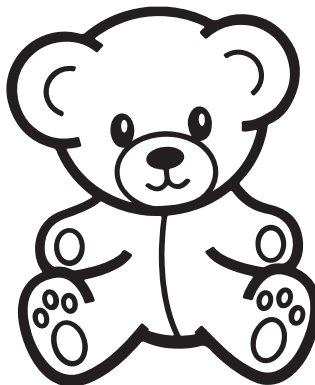

Traza.

1 1 1 1 1

Handwriting practice lines consisting of five sets of horizontal lines. Each set includes a solid top line, a dashed midline, and a solid bottom line.

Colorea uno.

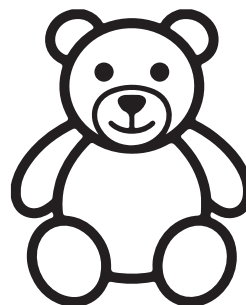
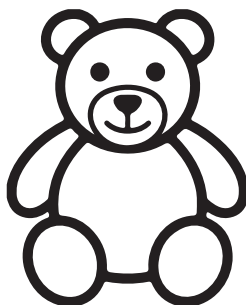
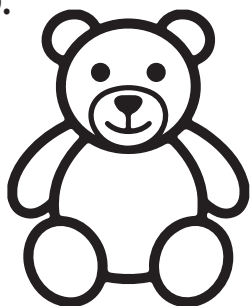

Dos



Traza.

22222

2

2

2

2

2

Colorea dos.



Tres

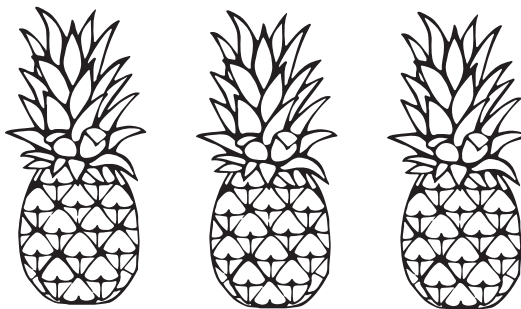

Traza.

3 3 3 3 3

3

3

3

3

3

Colorea tres.



Cuatro

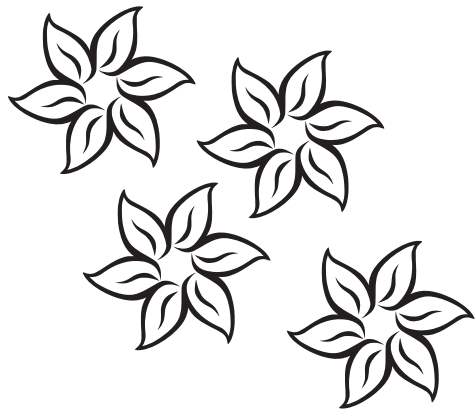

Traza.

4 4 4 4 4

Handwriting practice lines for the number 4. Each line set consists of a top line, a middle line, and a bottom line. The first four lines have a dotted number 4 at the beginning for tracing. The fifth line is blank.

Colorea cuatro.

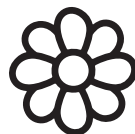

Cinco



Traza.

55555

5

5

5

5

5

Colorea cinco.

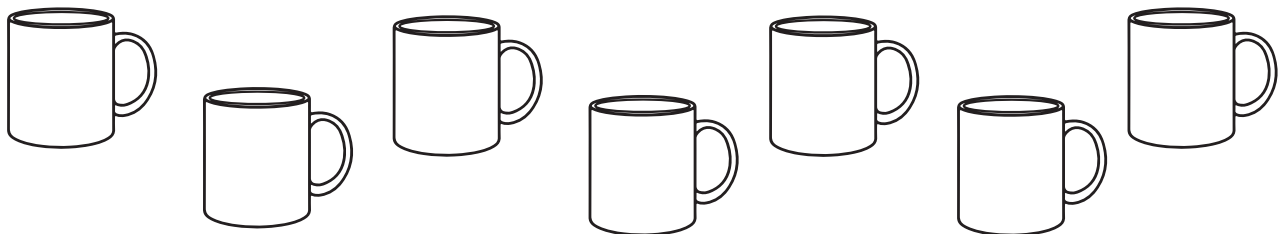

Seis

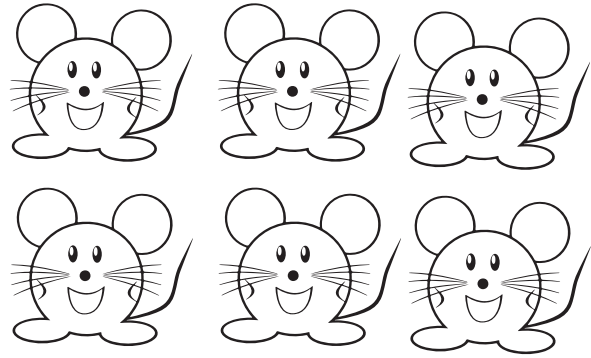
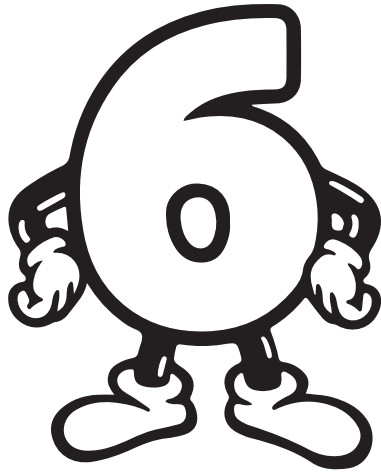

Traza.

6 6 6 6 6

6

6

6

6

6

Colorea seis.



Siete

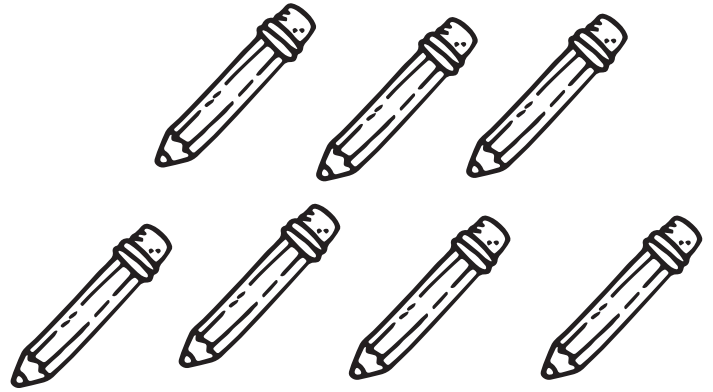

Traza.



Colorea siete.



Ocho

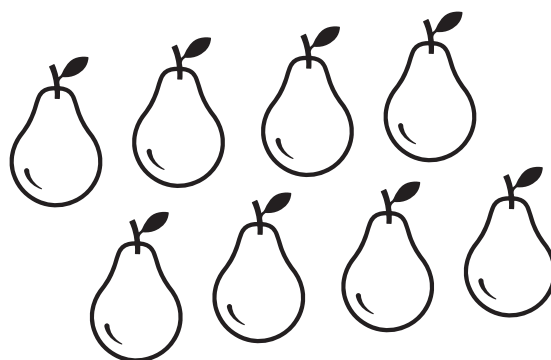
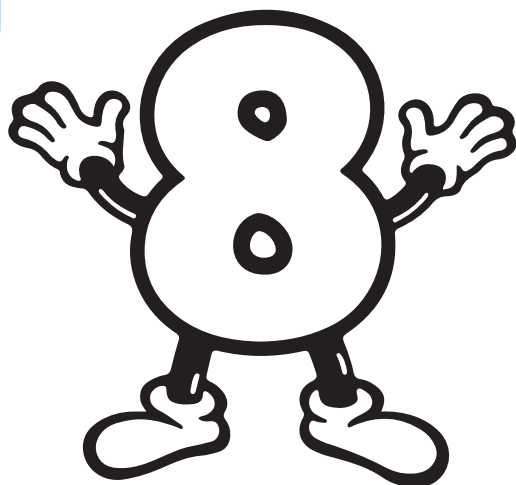

Traza.



Colorea ocho.

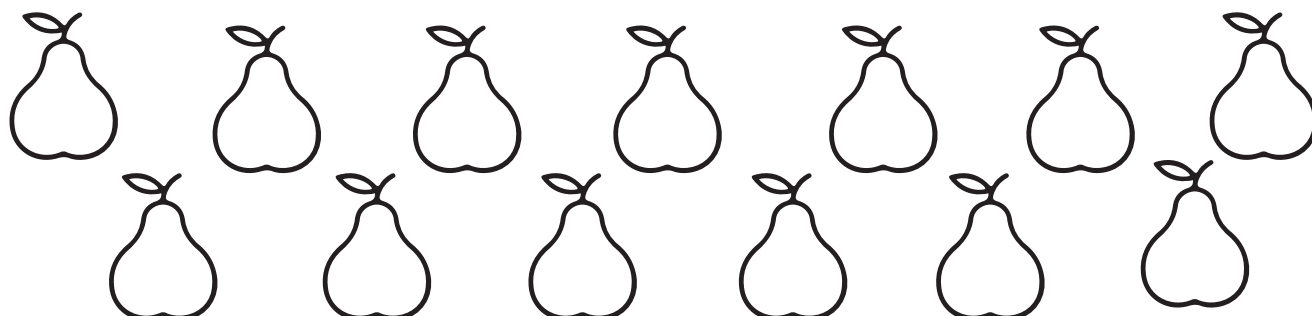

Nueve

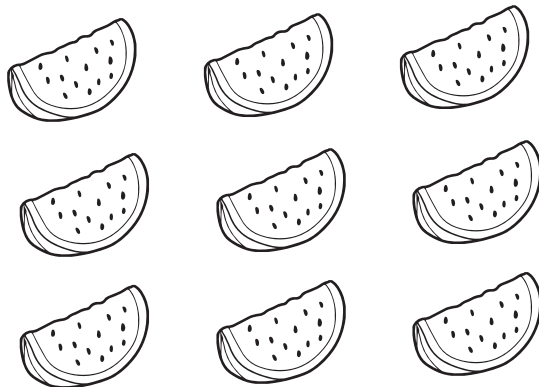
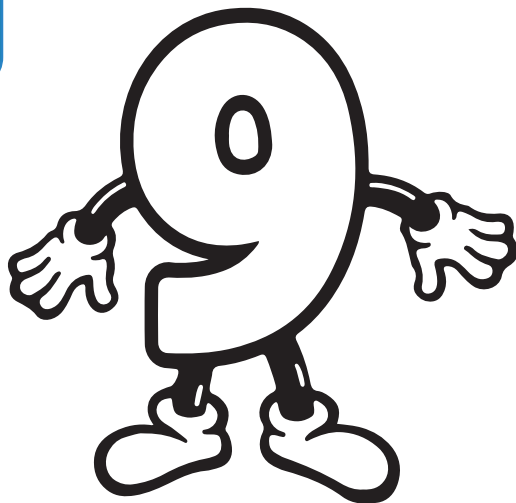

Traza.

9 9 9 9 9



Colorea nueve.

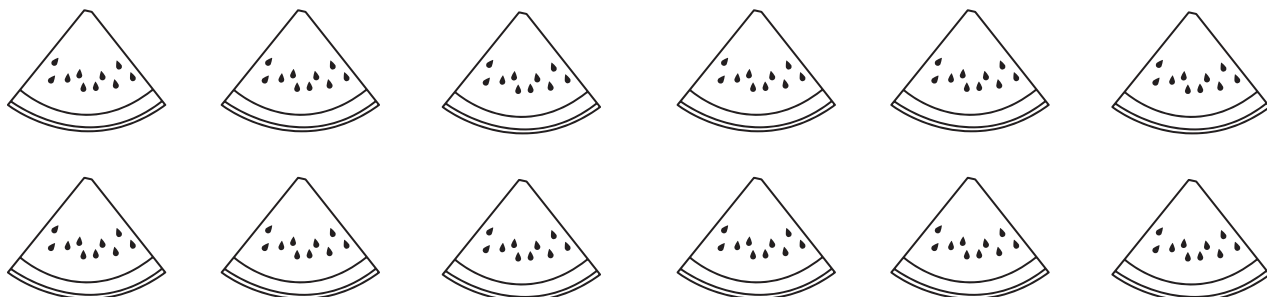

Diez

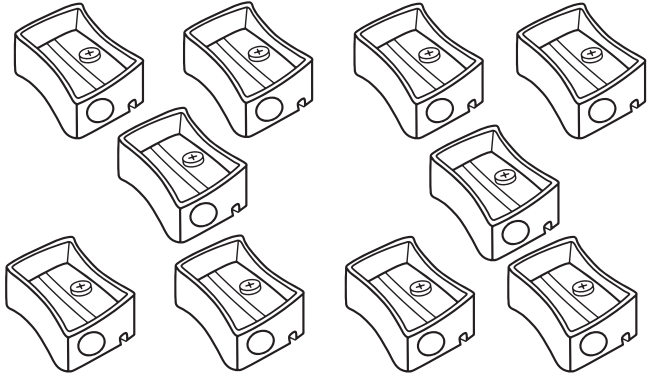
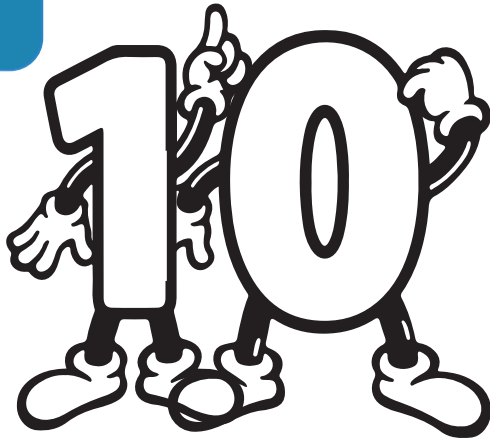

Traza.

10 10 10

10

10

10

10

10

Colorea diez.

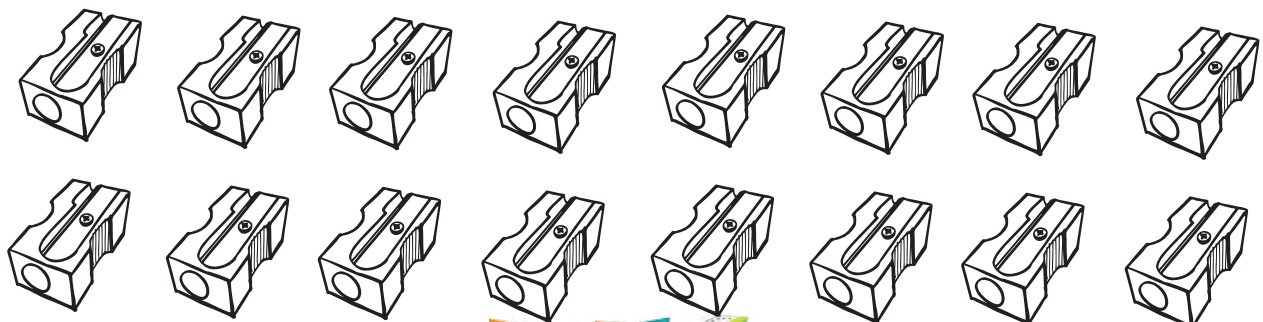

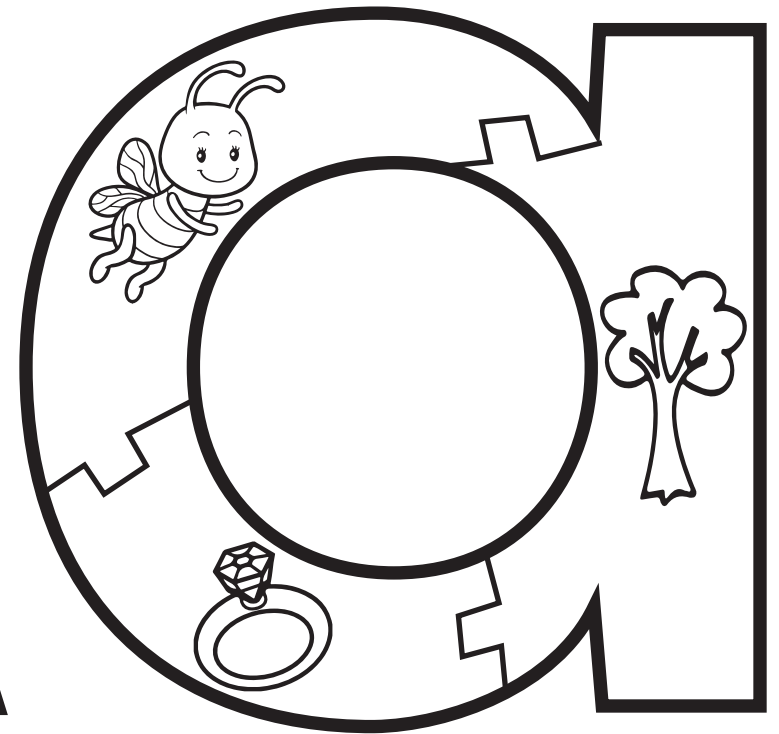
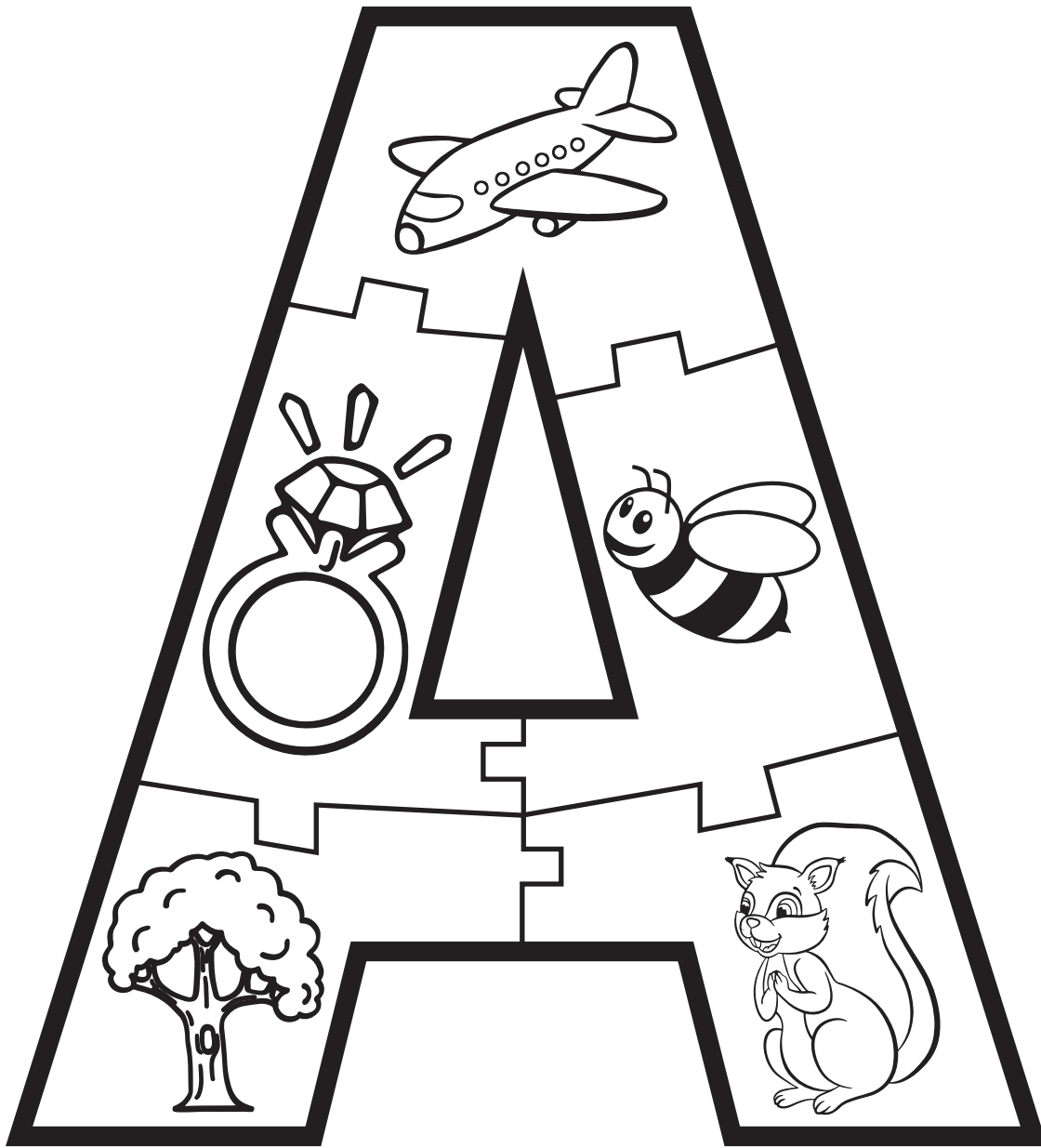

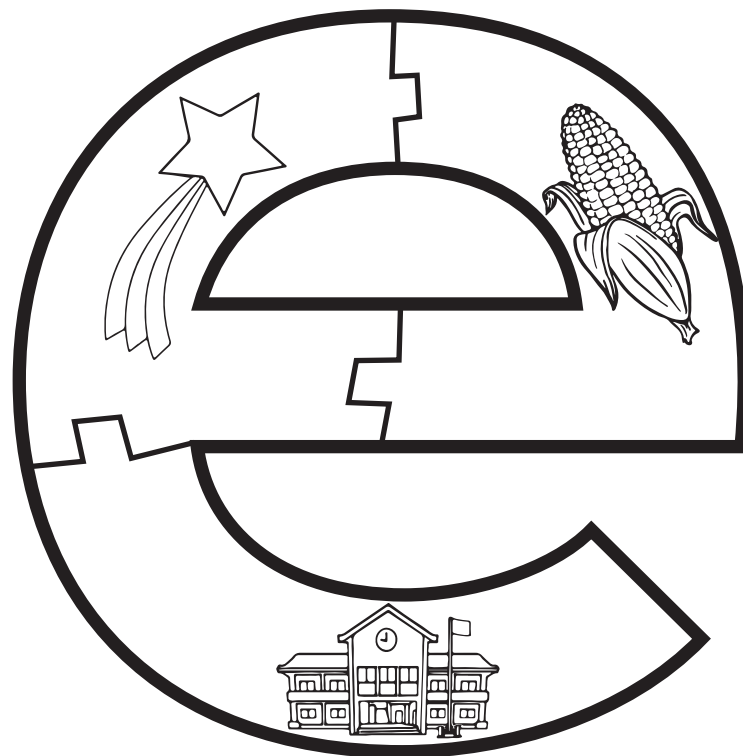
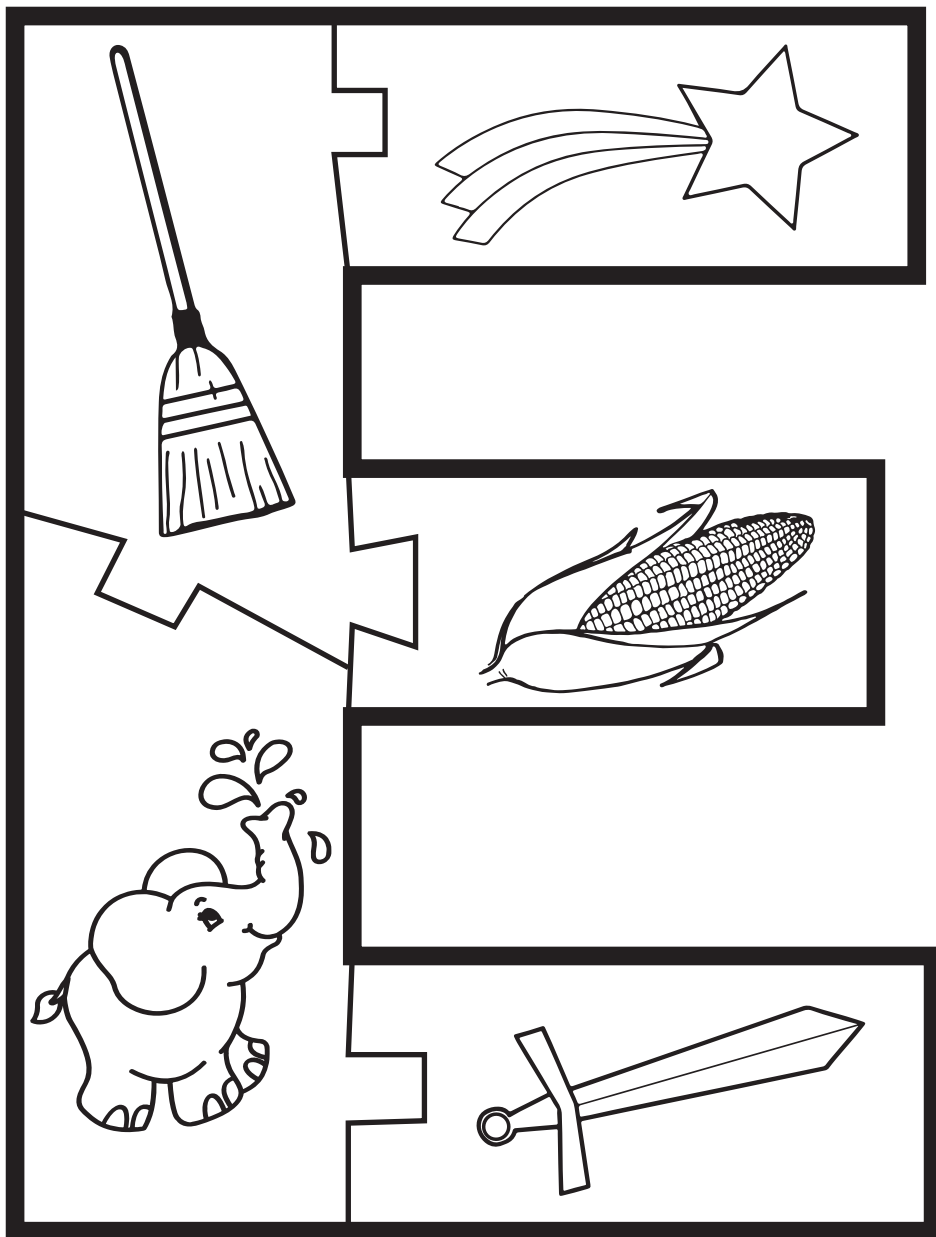

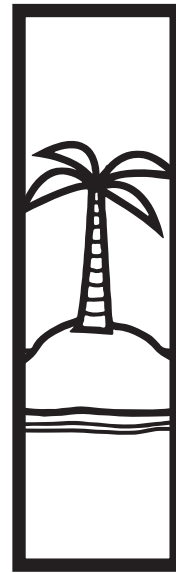
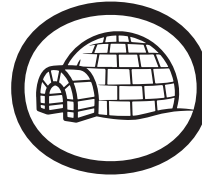
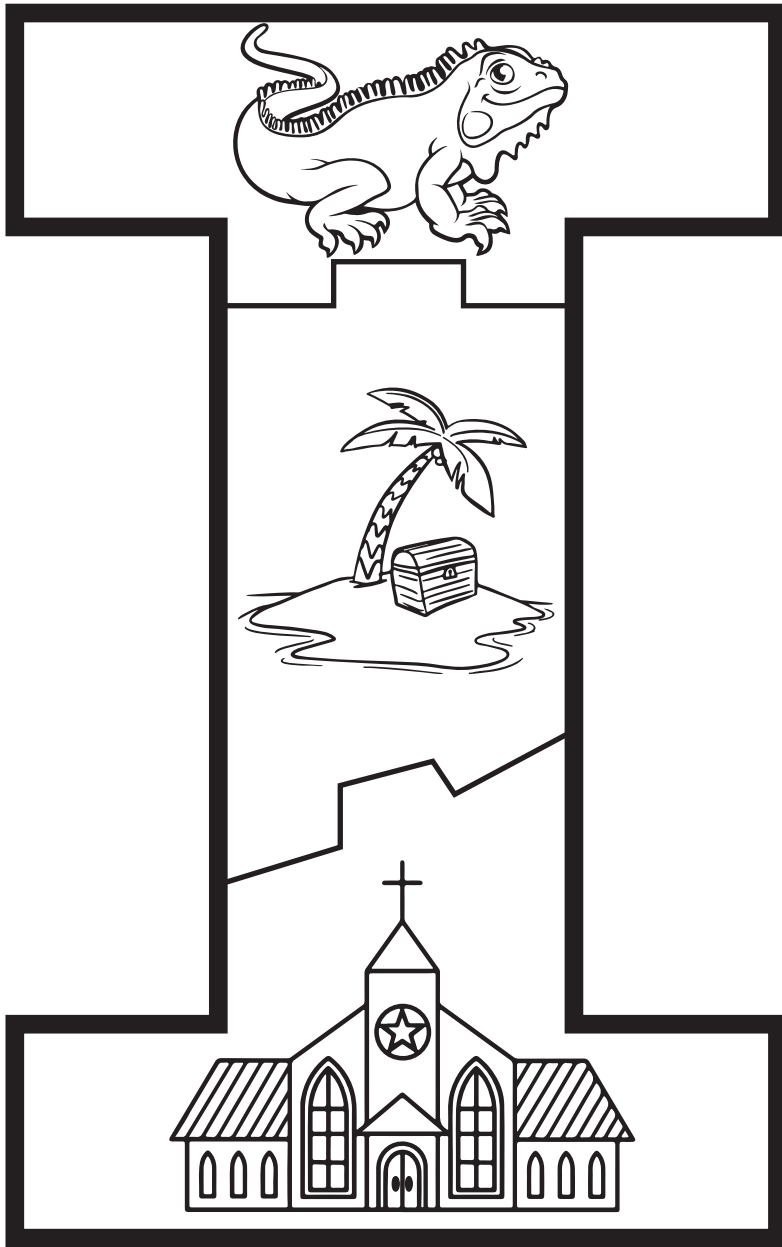

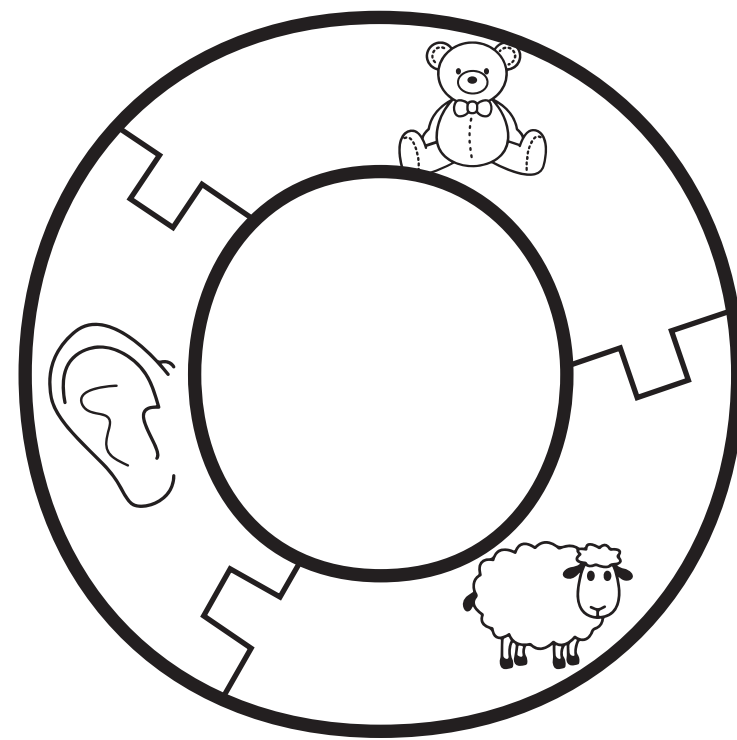
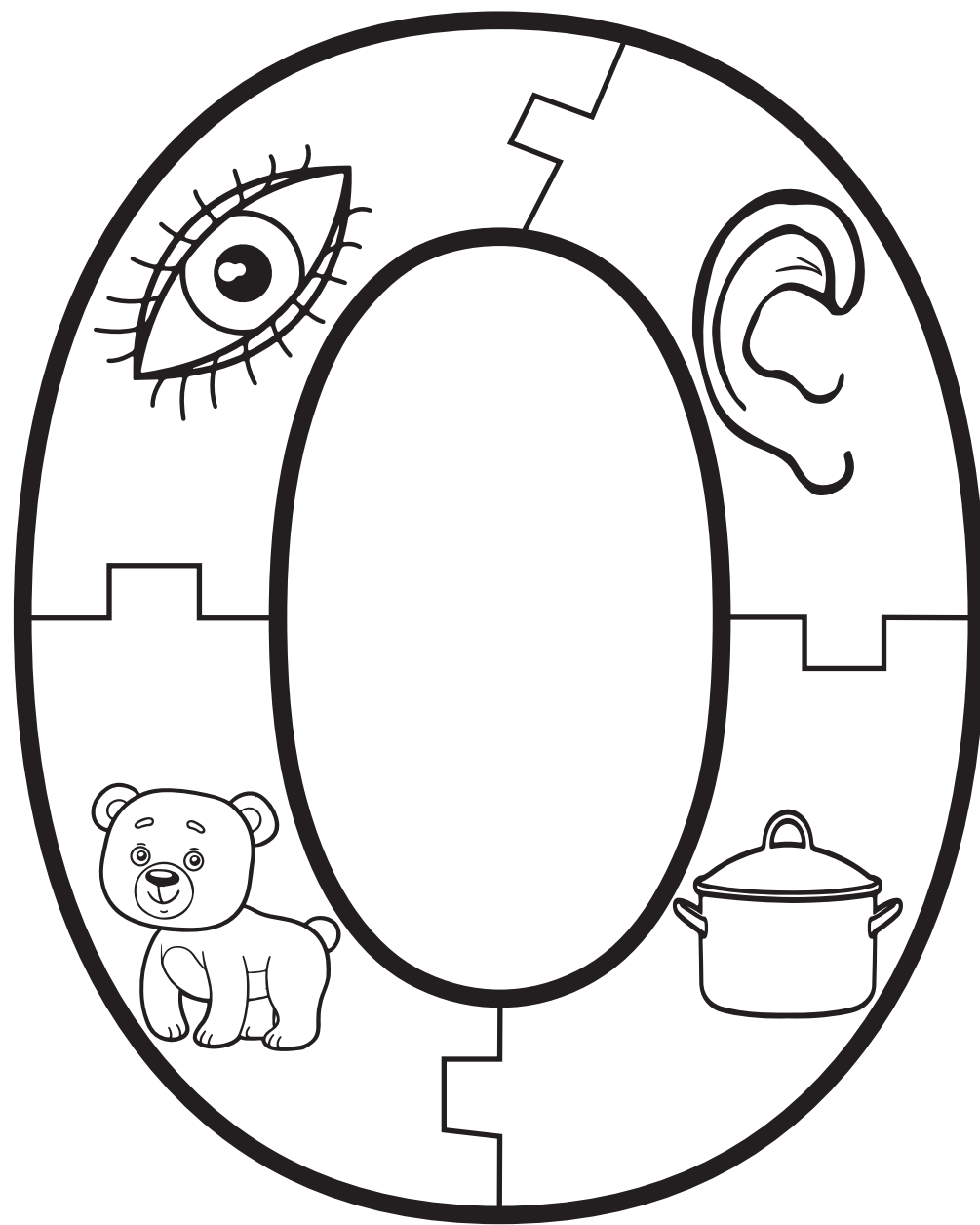

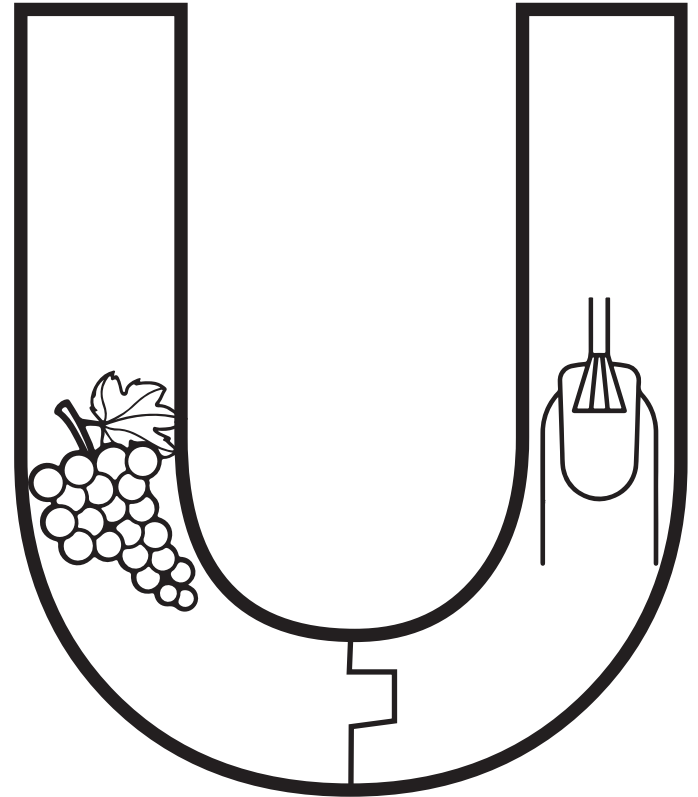
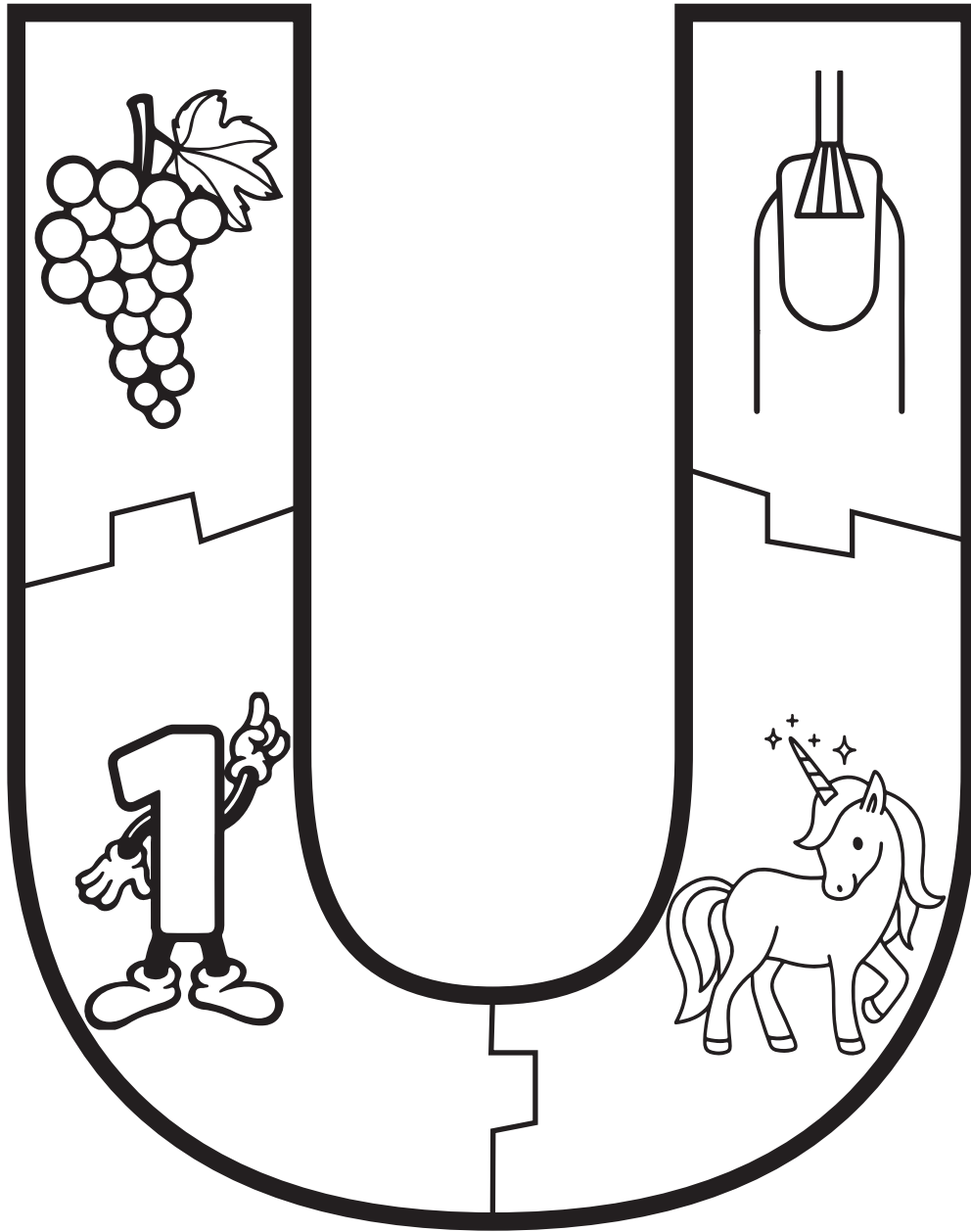

A a

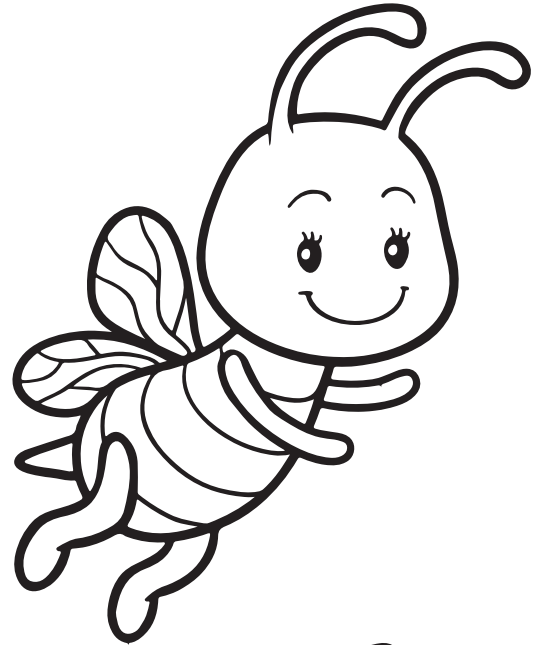

A A A

a a a



Bb

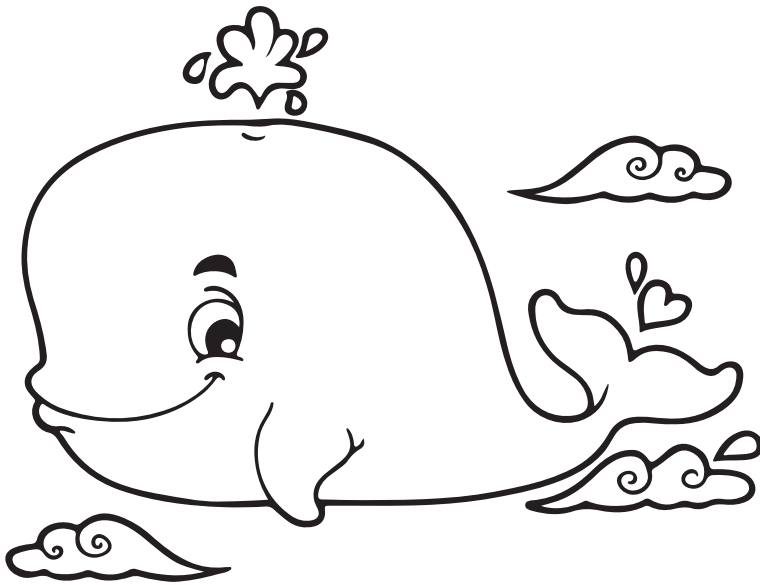
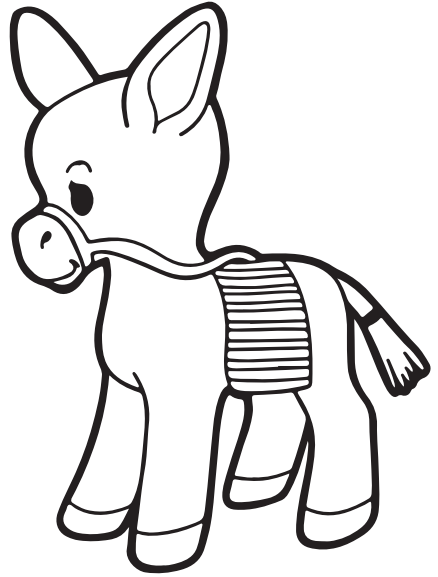

www.materialparamaestros.com

BBB

bbb

Cc

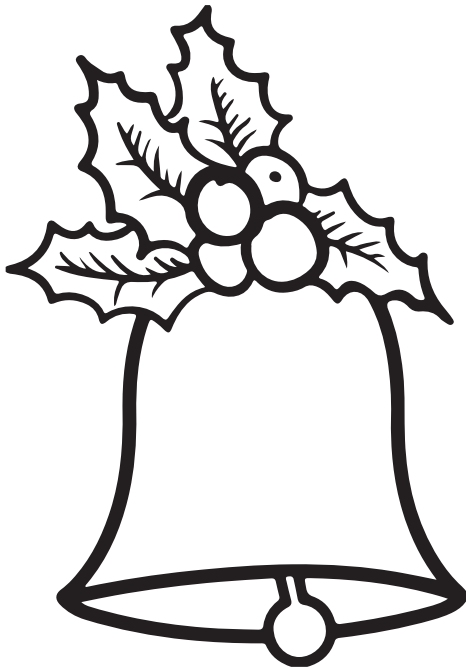
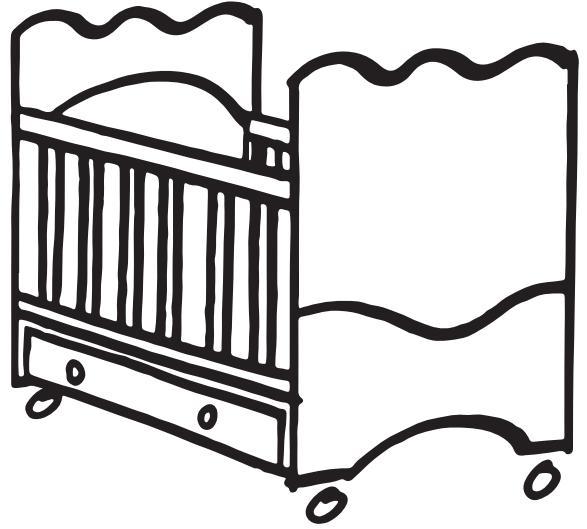

ccc

ccc

Dd

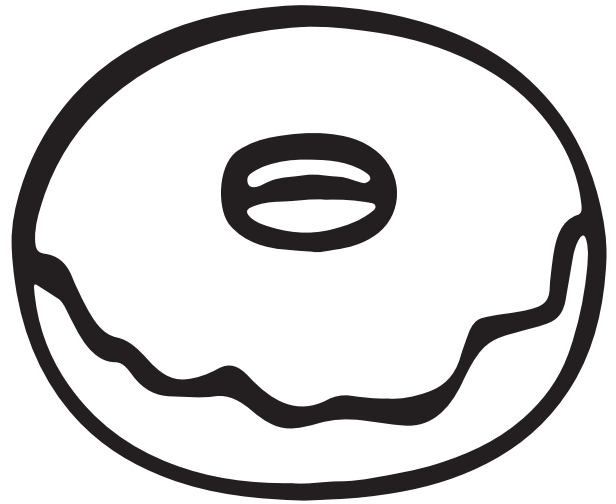
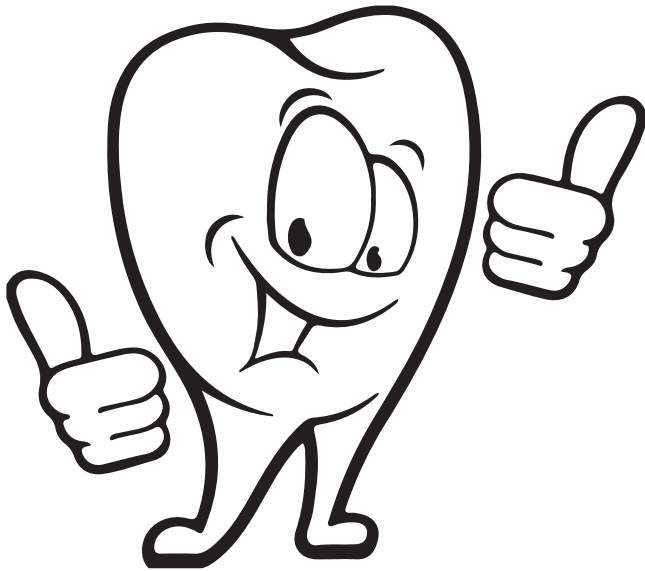
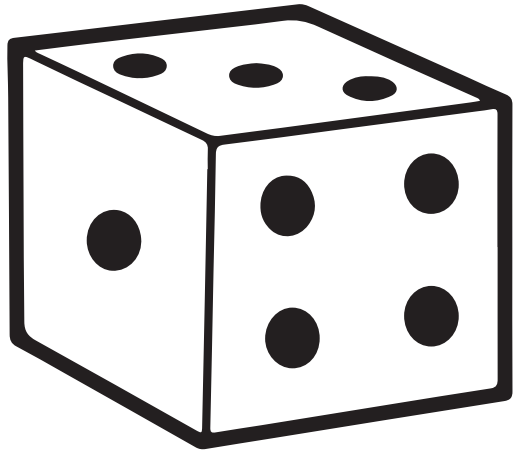

www.materialparamaestros.com

DDD

ddd

Ee

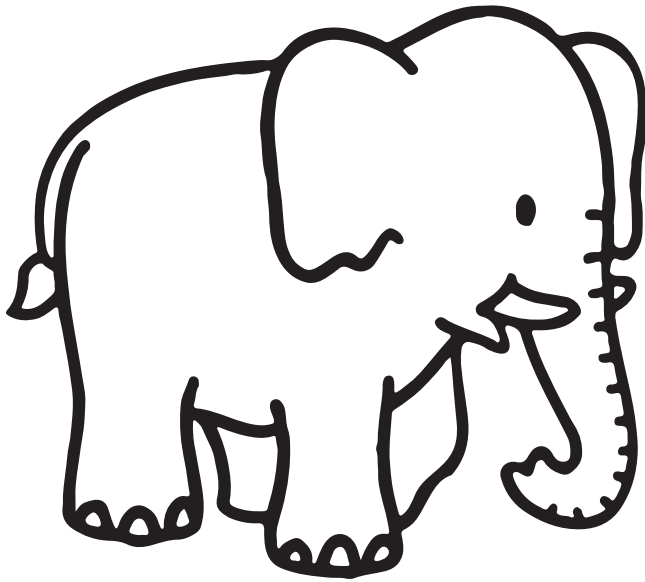
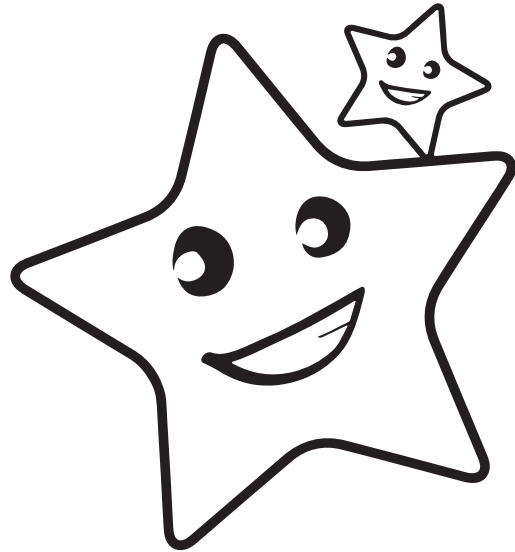

EEE

eee

Ff

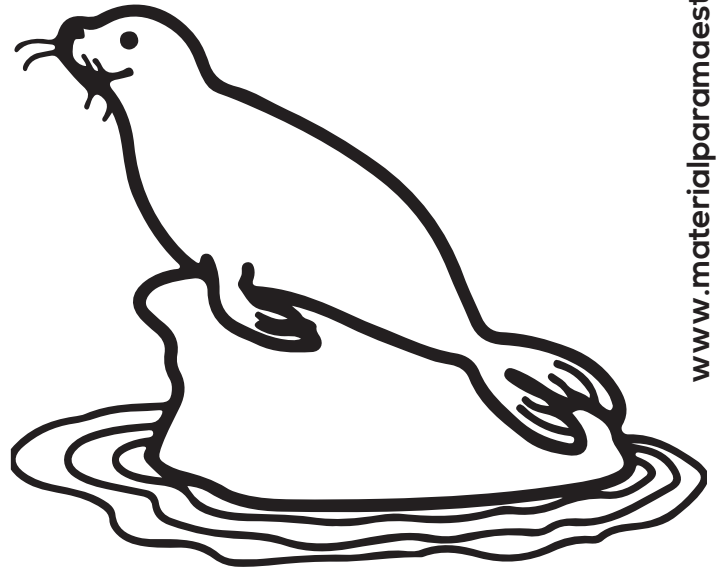
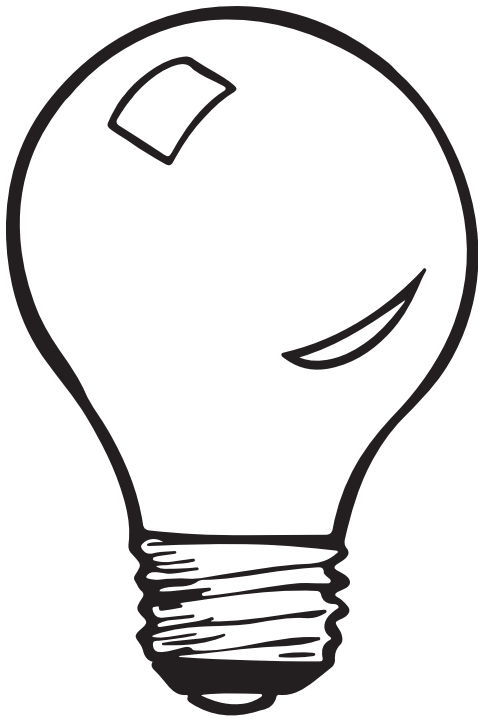
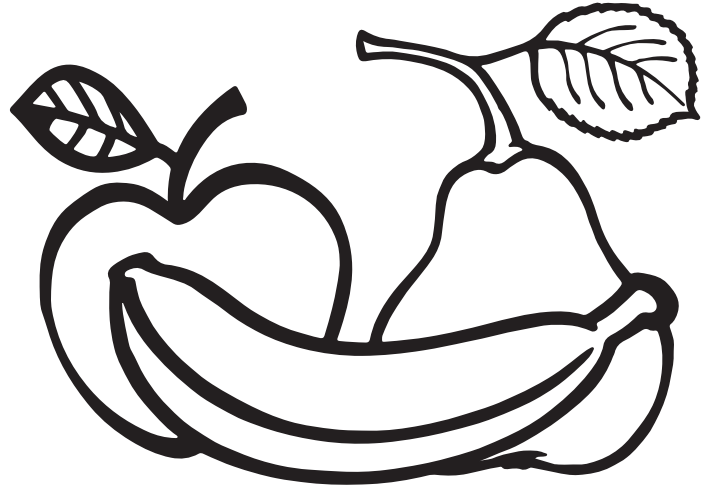

FFF

fff

Gg

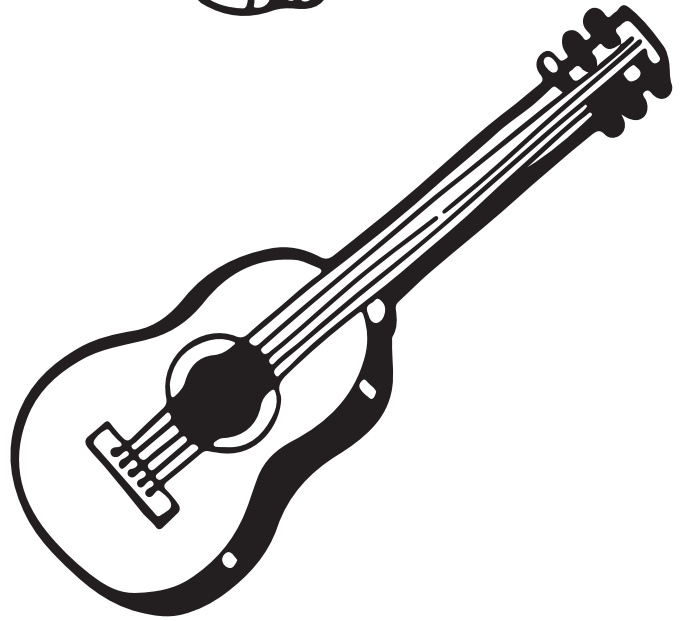
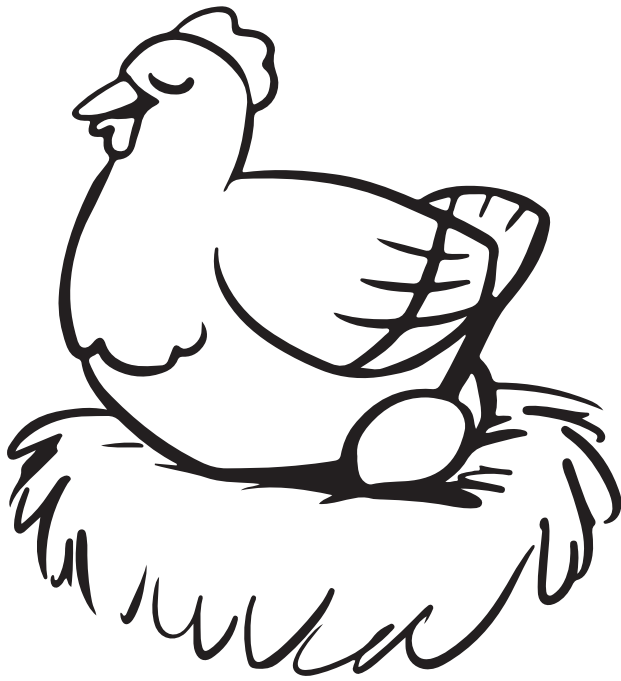
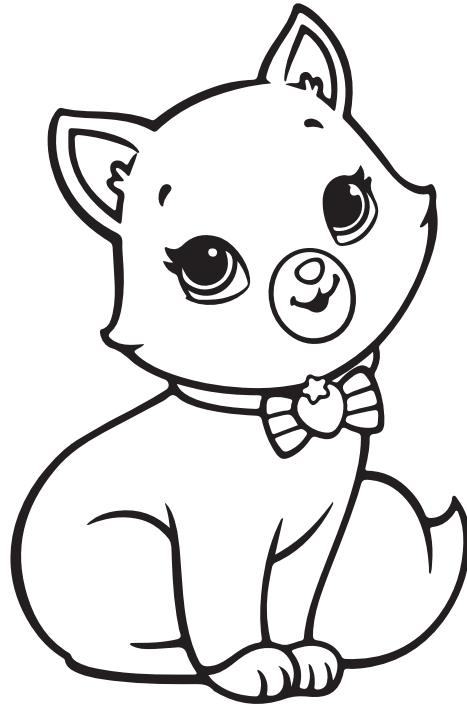

www.materialparamaestros.com

GGG

ggg

Hh

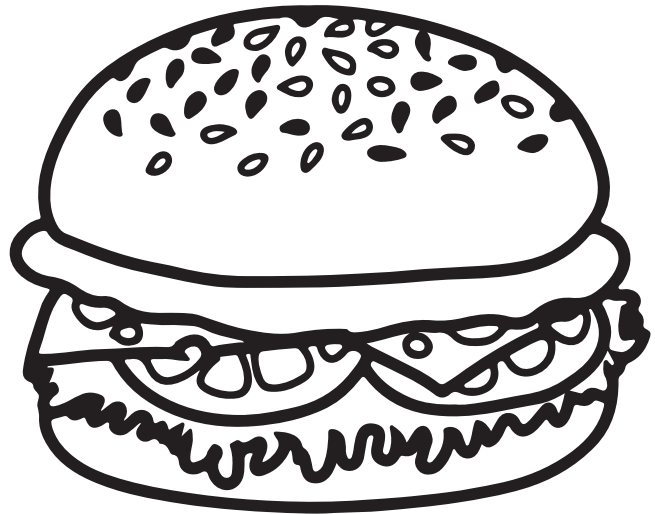
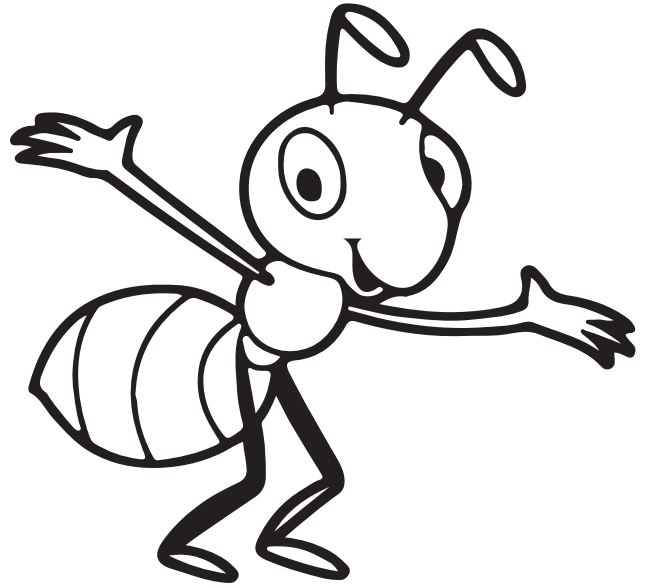

www.materialparamaestros.com

H H H H

h h h h

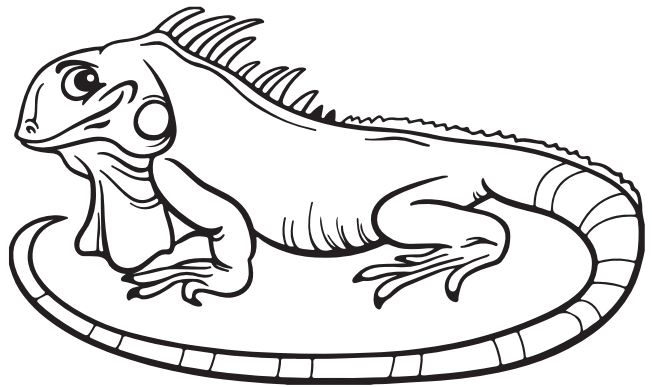
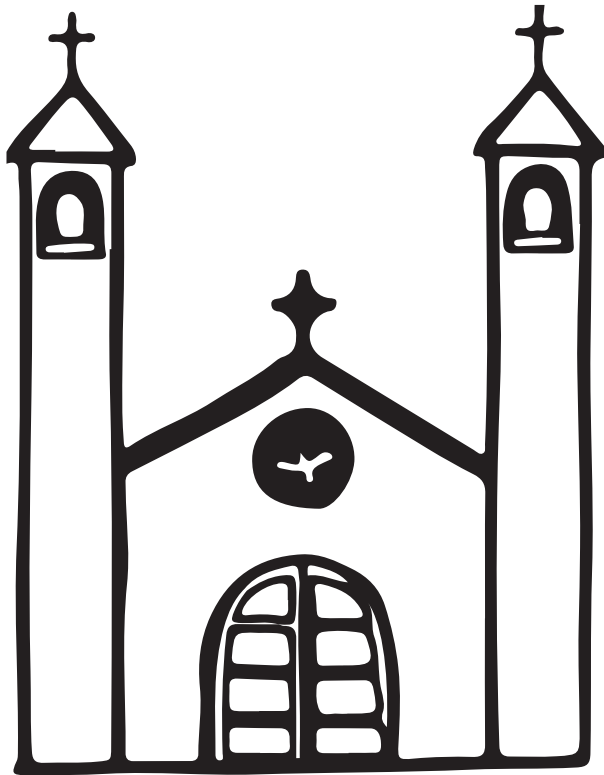
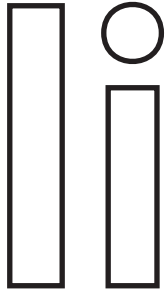

www.materialparamaestros.com

iii

iii

Jj

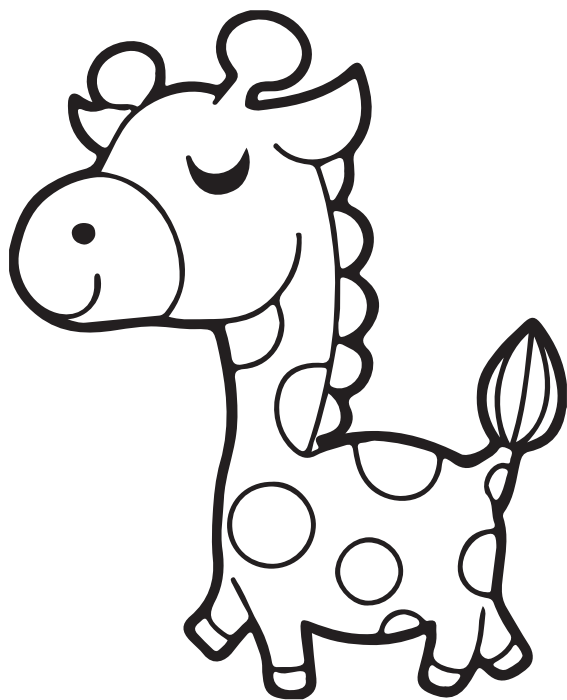
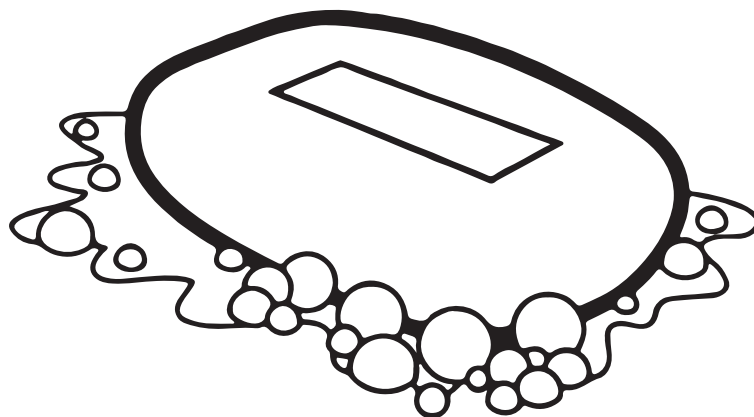

www.materialparamaestros.com

J J J

j j j

Kk

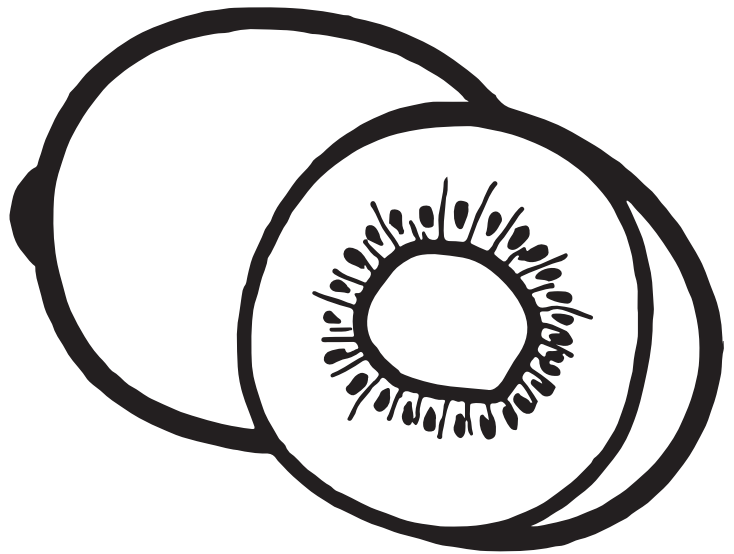
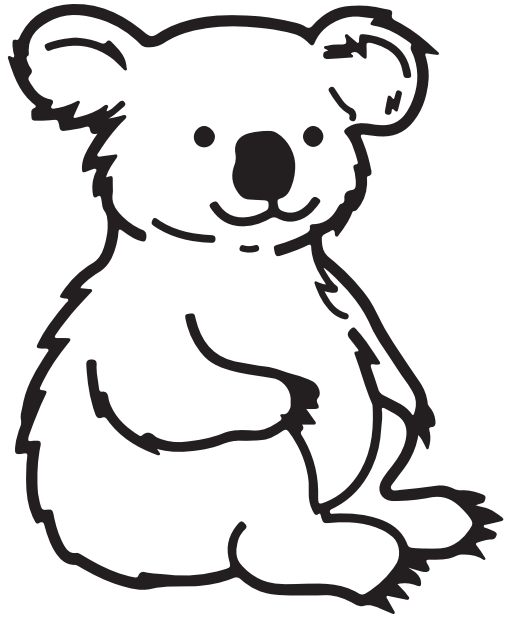

Kkk

kkk

LI

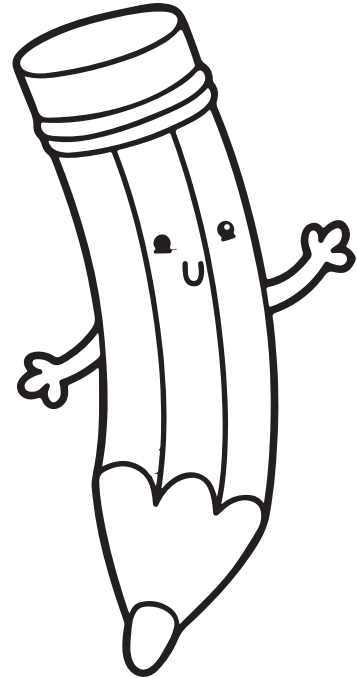

LI LI LI

LI LI LI

Mm

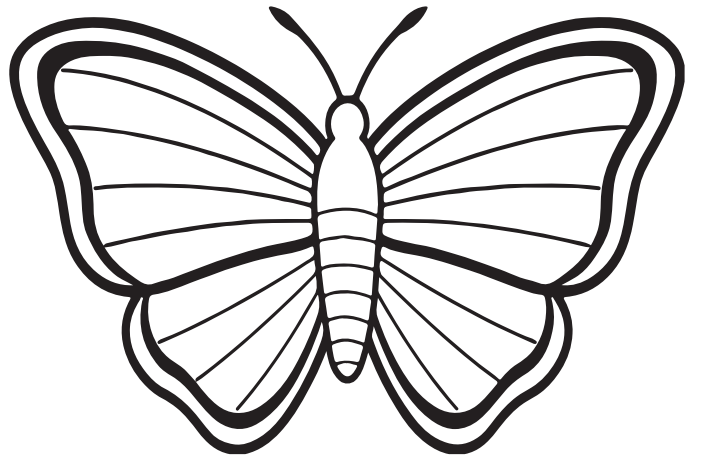

www.materialparamaestros.com

MMM

mmm

Nn

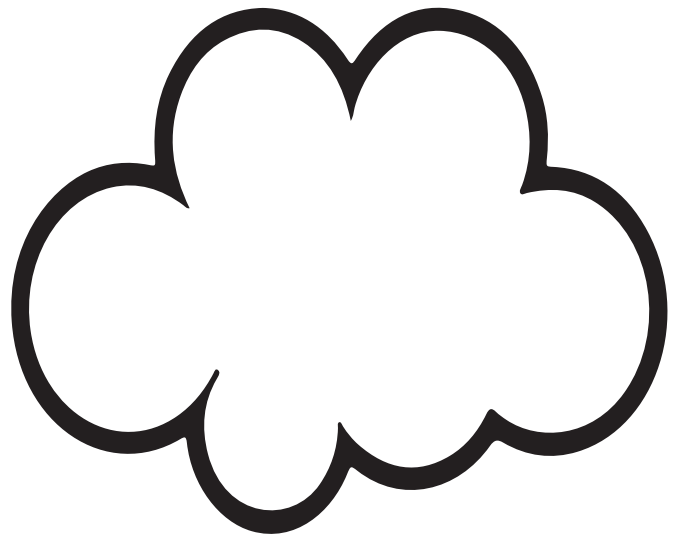

NNN

nnn

N ñ

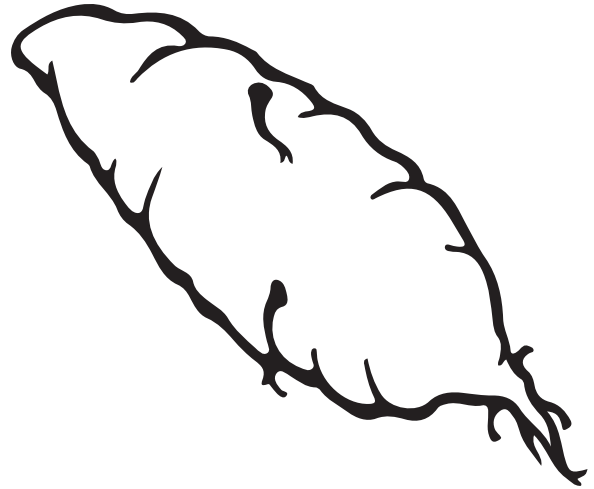
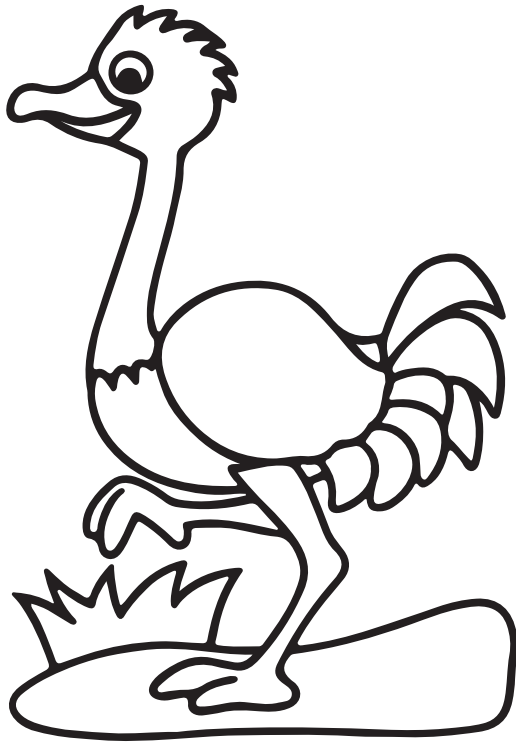
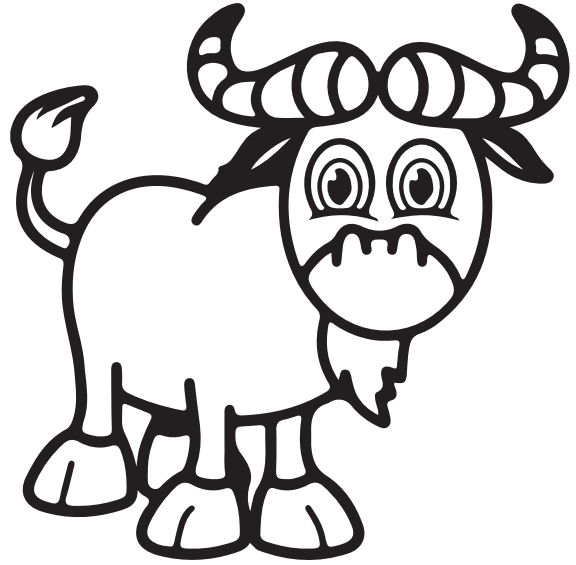

N N N

ñ ñ ñ

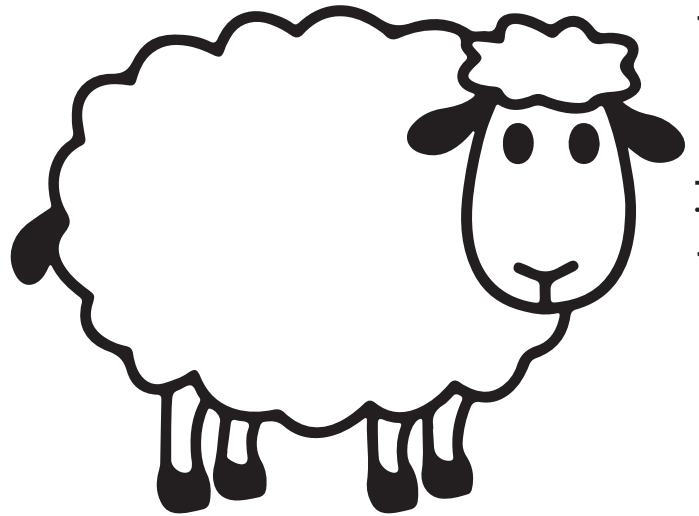
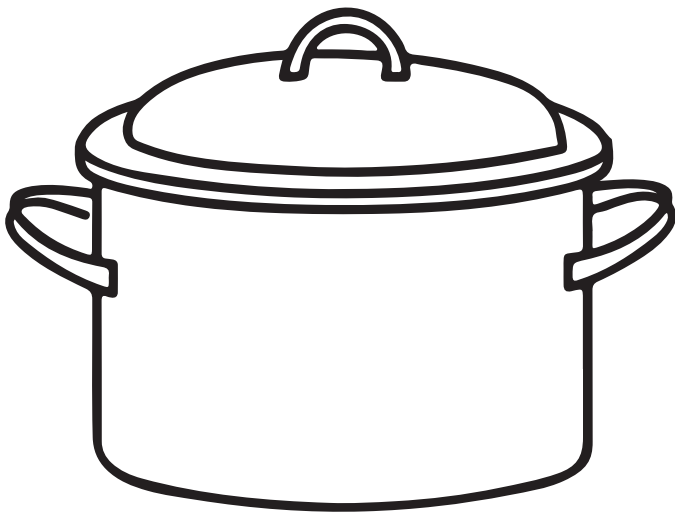
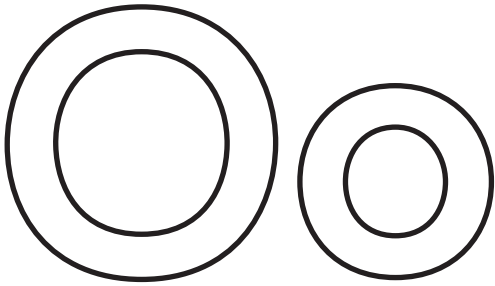

www.materialparamaestros.com



Pp

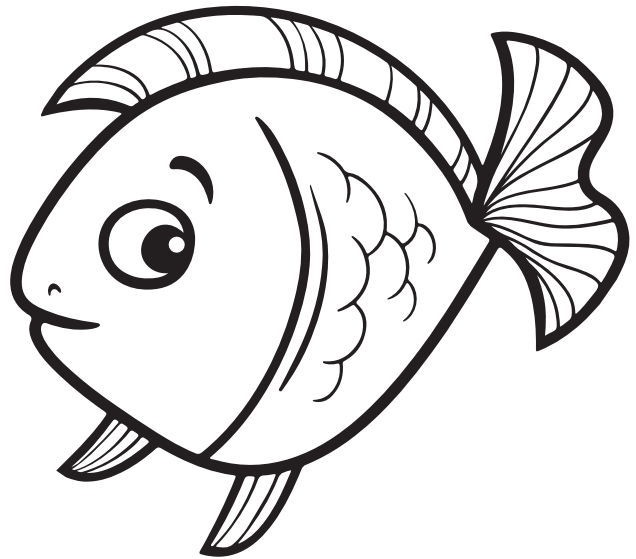
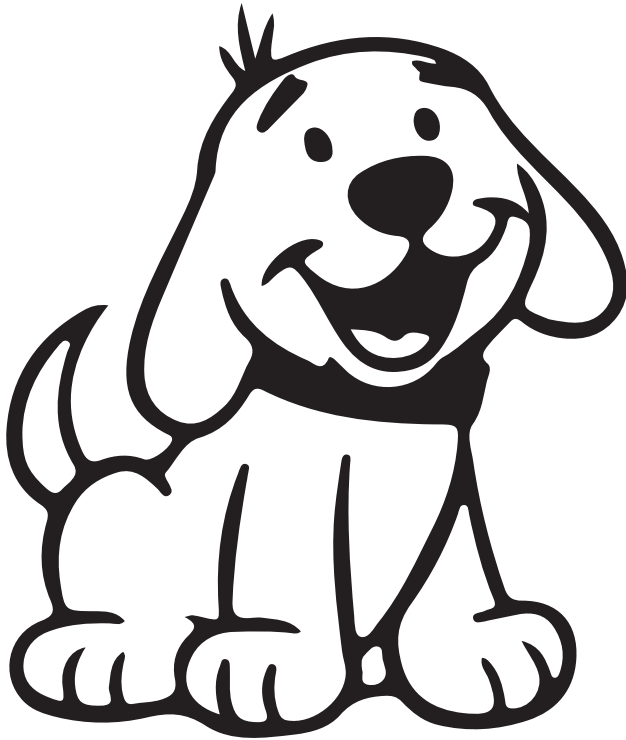

ppp

ppp

Qq

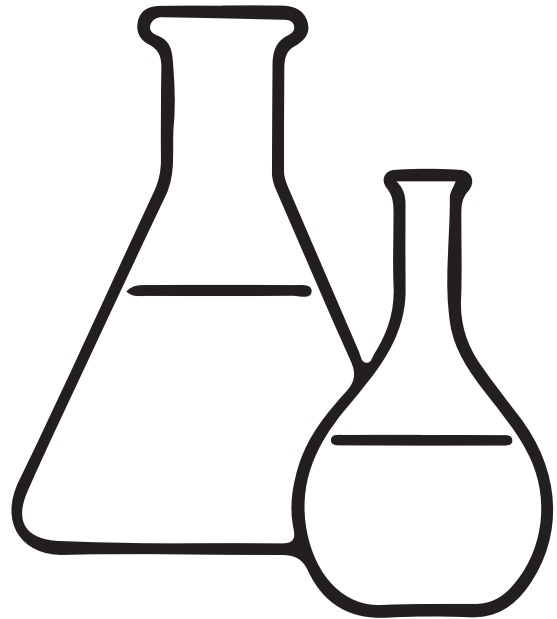
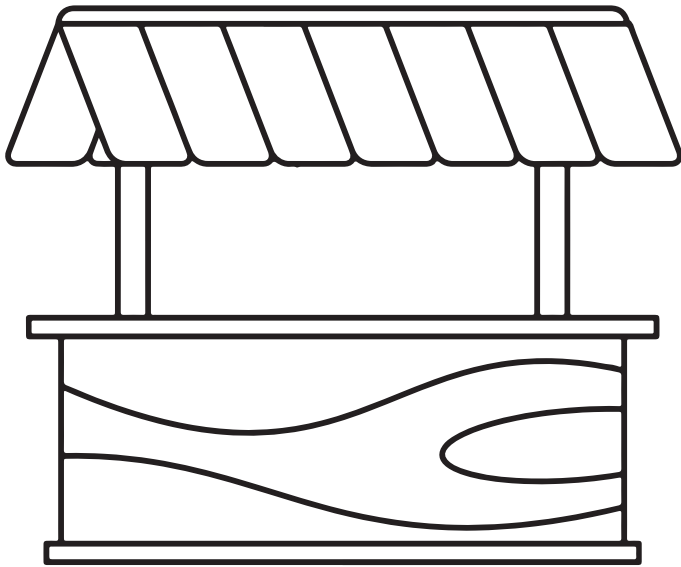
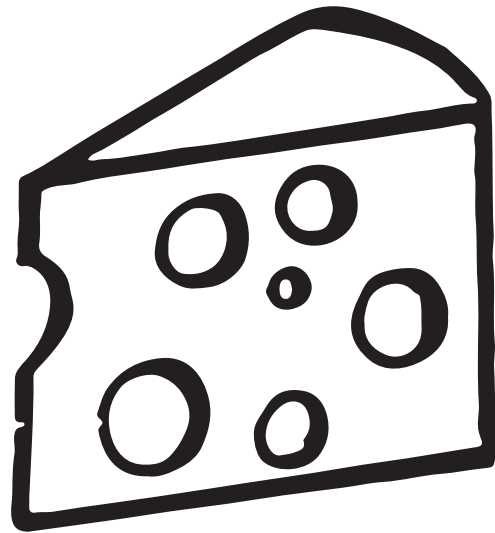

Q Q Q

q q q

Rr

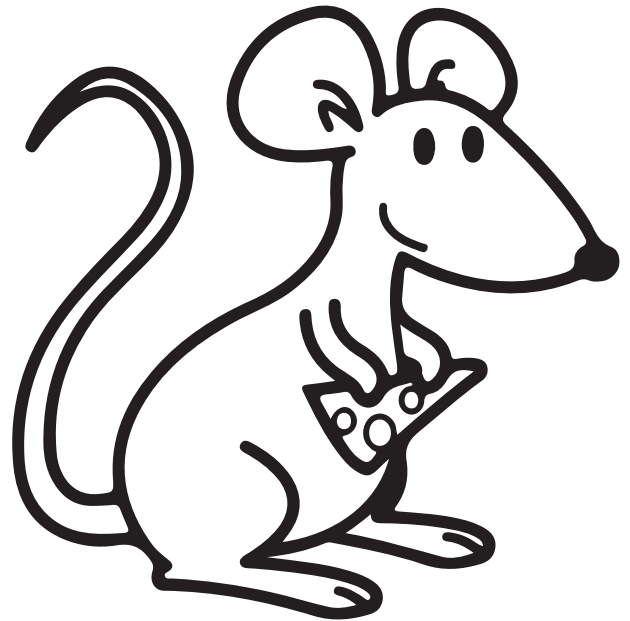
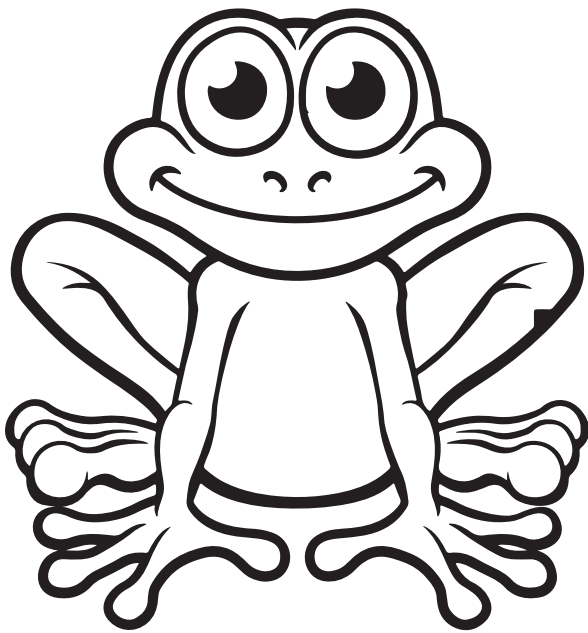
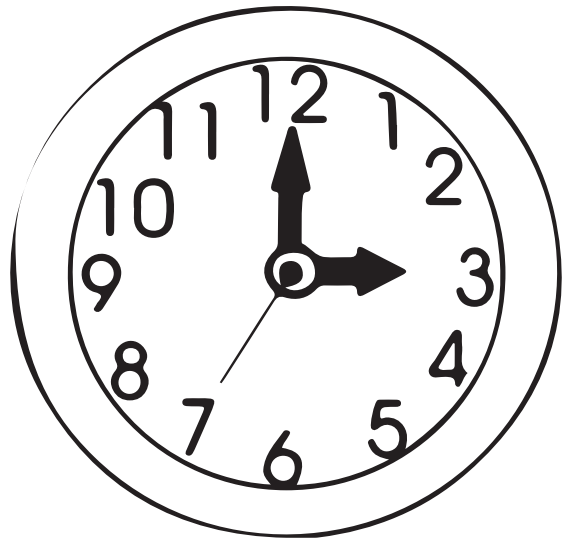

www.materialparamaestros.com

RRR

rrr

Ss

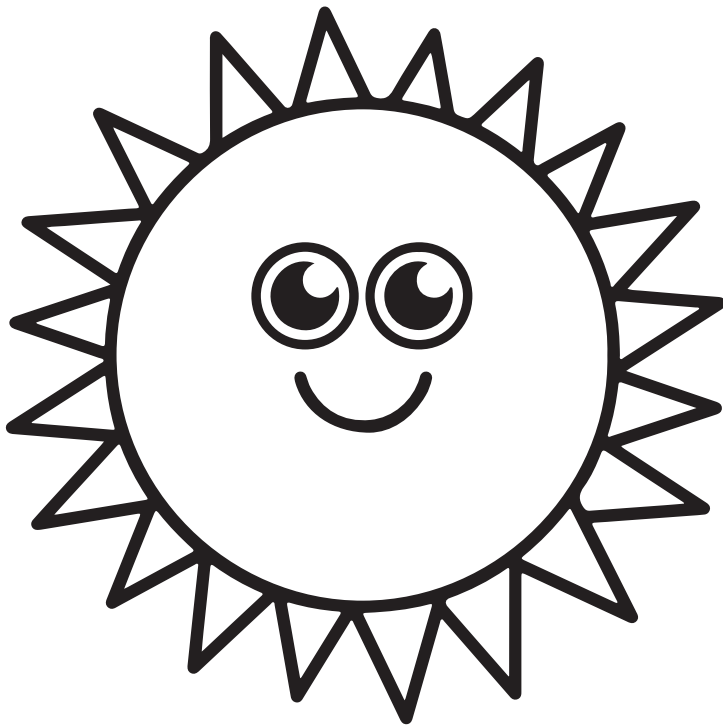
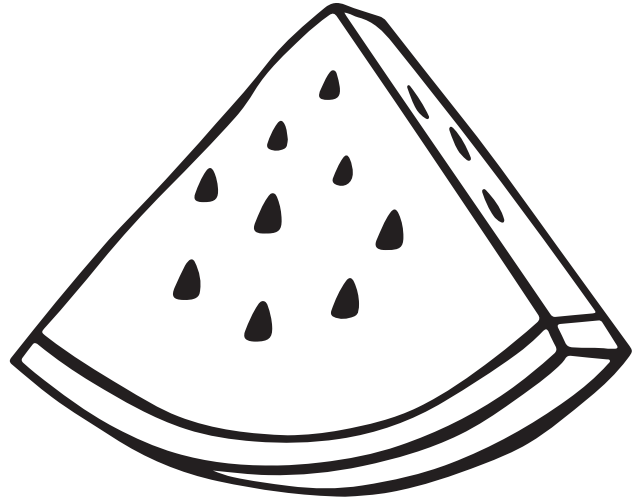

www.materialparamaestros.com

S S S

s s s

Tt

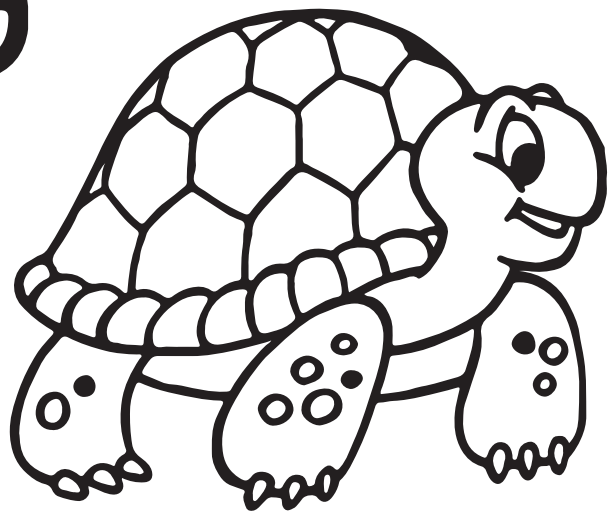
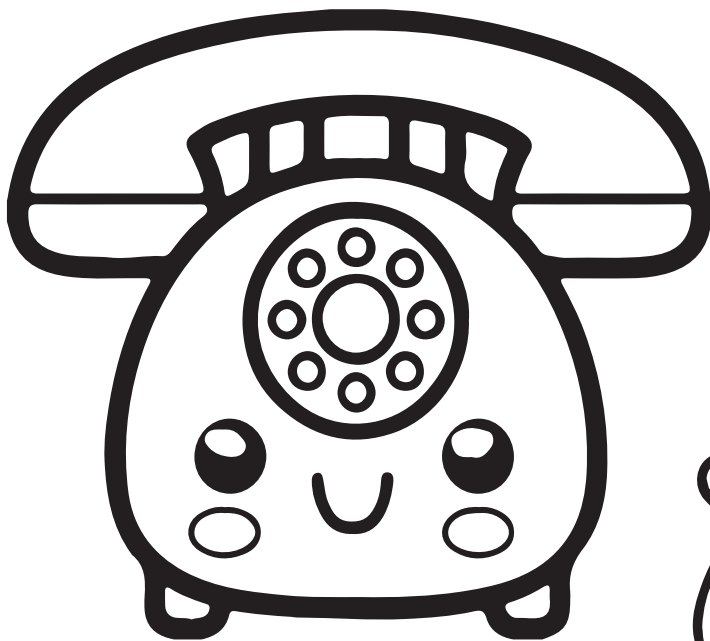
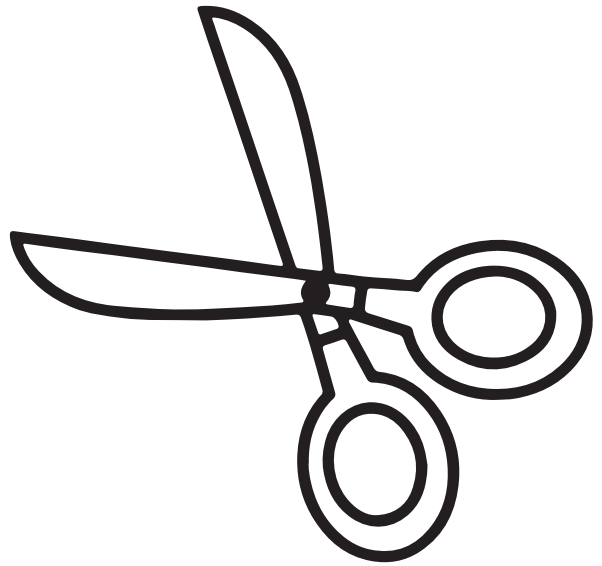

T T T

t t t



U u

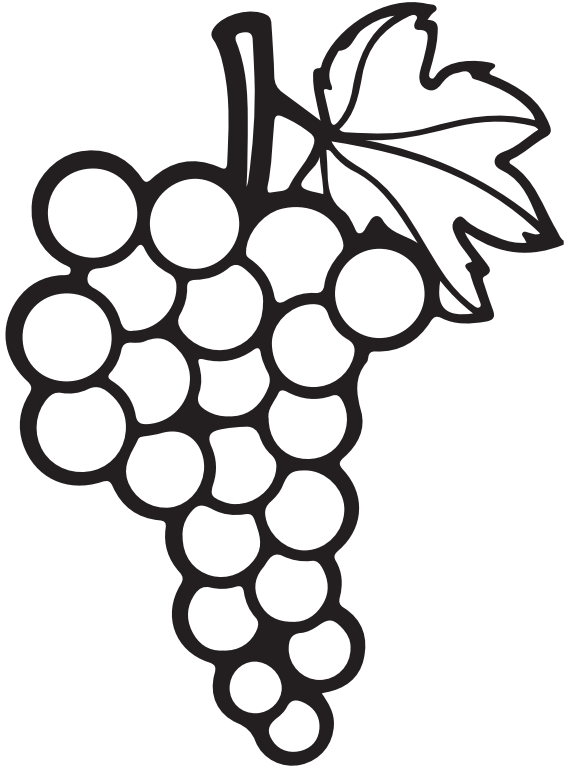
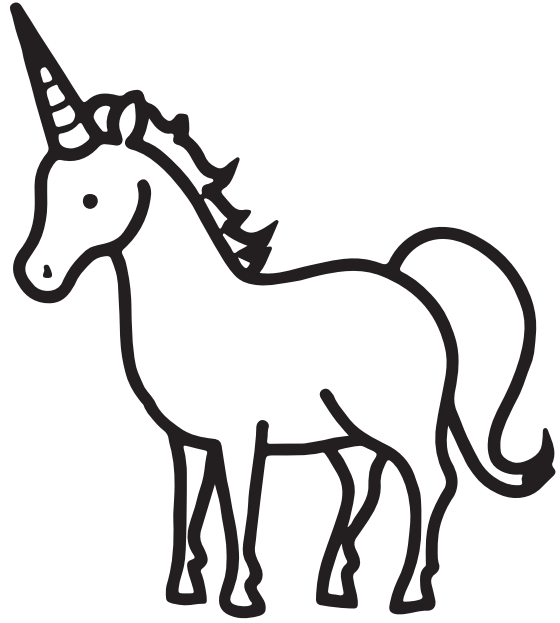

uuuu

uuuu

V v

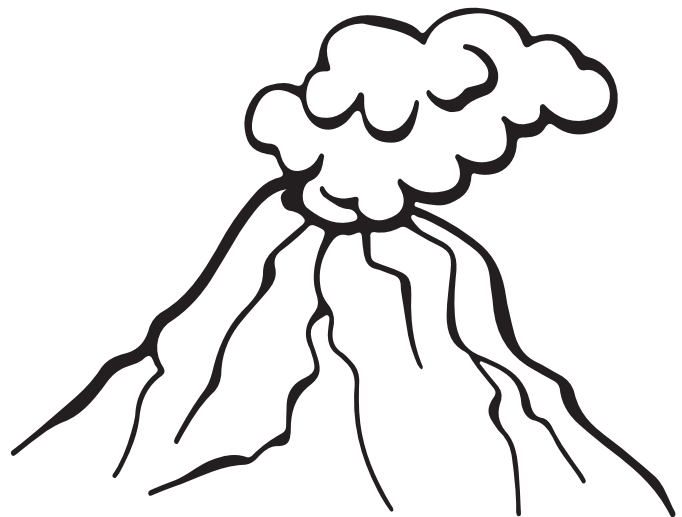
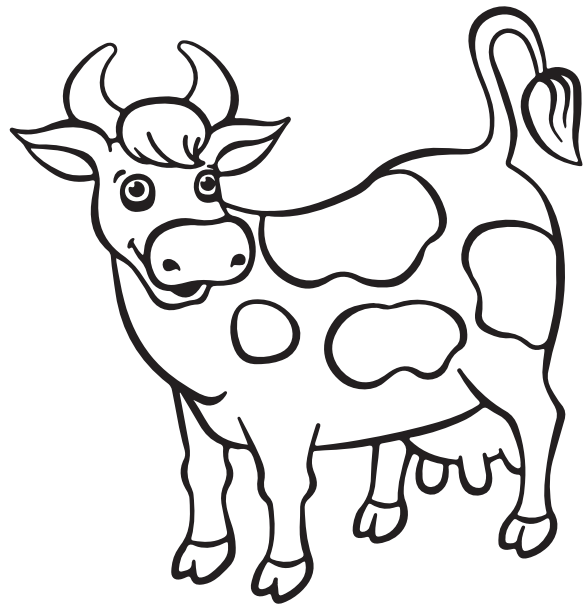

V v

V v

Ww

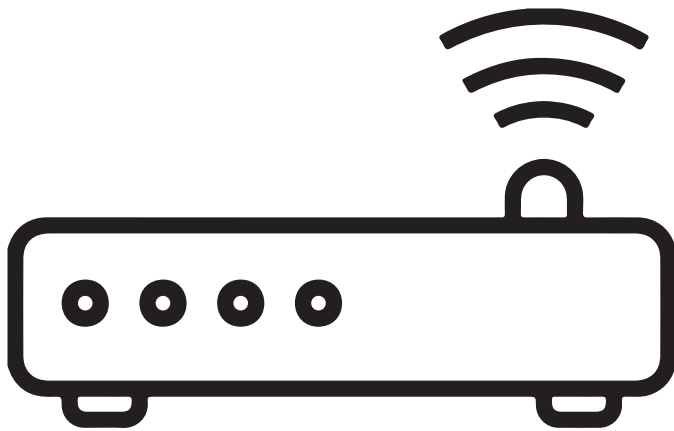

http://www.

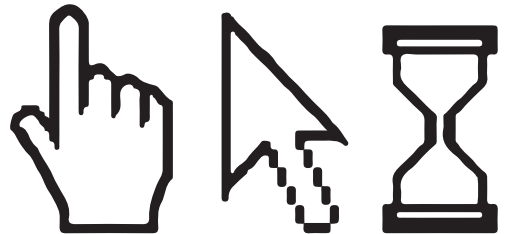

www.materialparamaestros.com

WwW

WwW

Xx

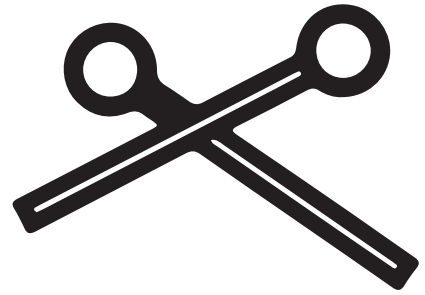
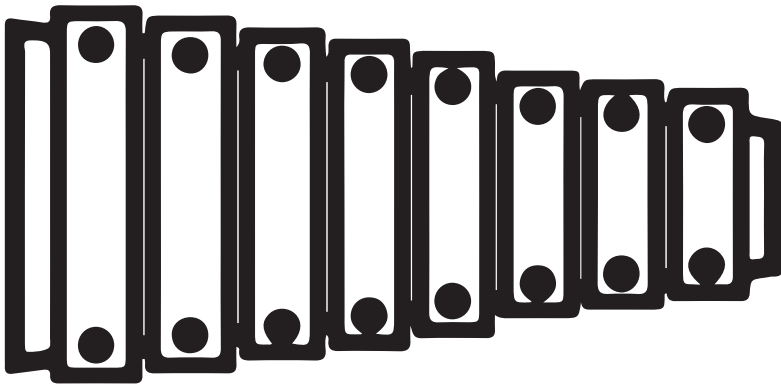

X X X

x x x

Y y

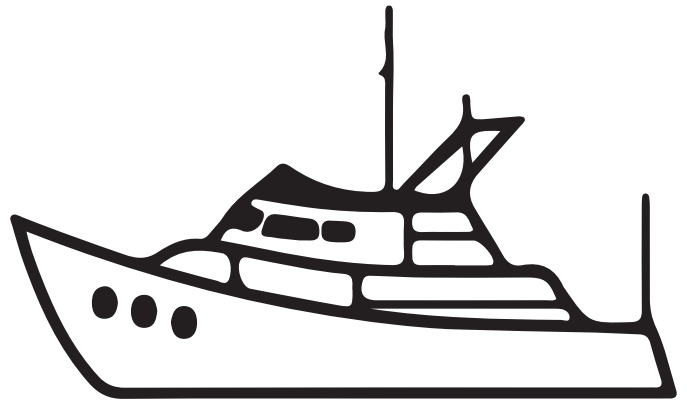
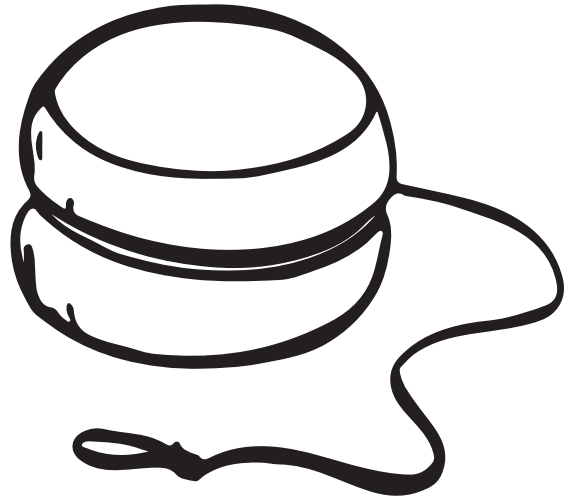

www.materialparamaestros.com

Y Y Y

y y y

Zz

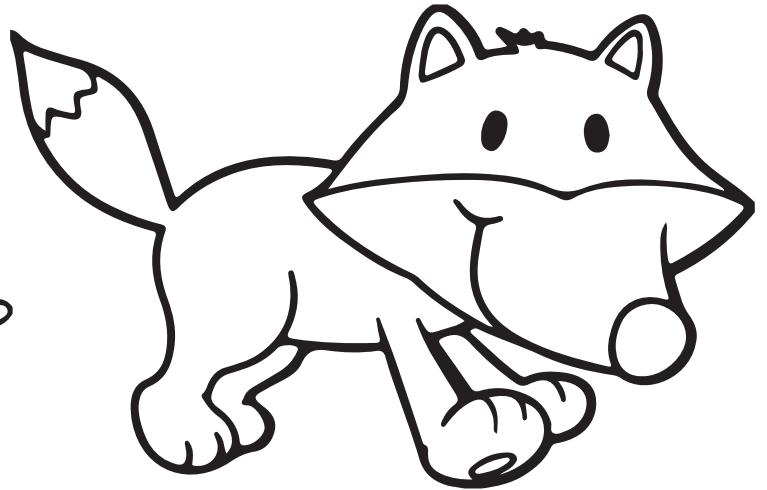
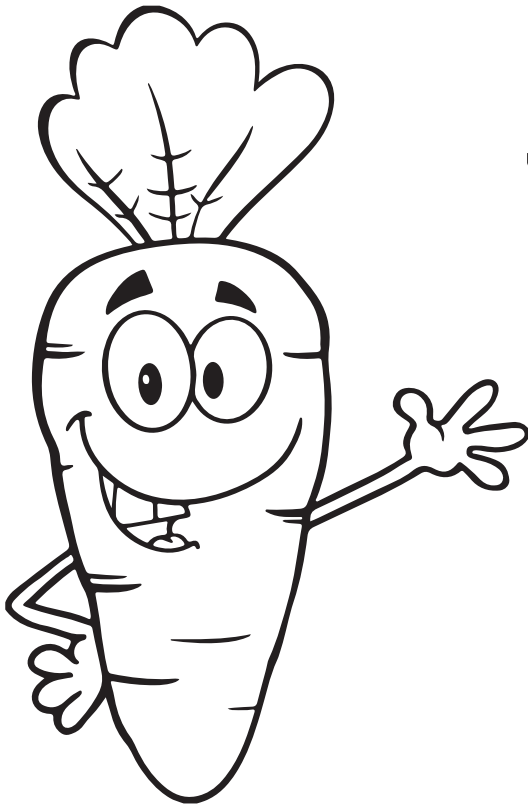





www.materialparamaestros.com



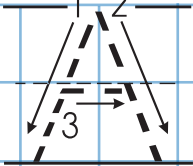
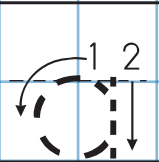
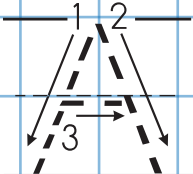
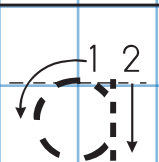
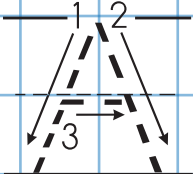
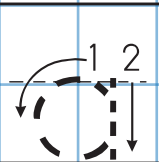

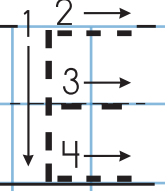
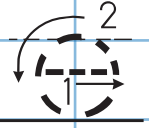
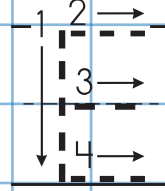
Zz

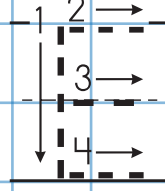
Zz

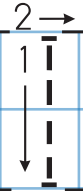

1																				
2																				
3																				
-																				
1																				
2																				
3																				
-																				
1																				
2																				
3																				
-																				
1																				
2																				
3																				
-																				
1																				
2																				
3																				
-																				
1																				
2																				
3																				

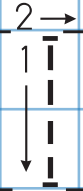
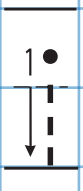
1																				
2																				
3																				
-																				
1																				
2																				
3																				
-																				
1																				
2																				
3																				
-																				
1																				
2																				
3																				
-																				
1																				
2																				
3																				
-																				
1																				
2																				
3																				

1																				
2																				
3																				
-																				
1																				
2																				
3																				
-																				
1																				
2																				
3																				
-																				
1																				
2																				
3																				
-																				
1																				
2																				
3																				
-																				
1																				
2																				
3																				

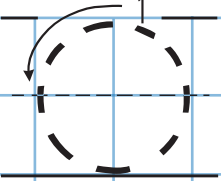
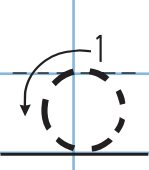
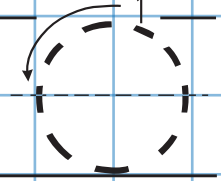
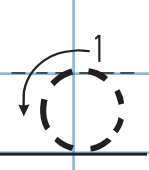
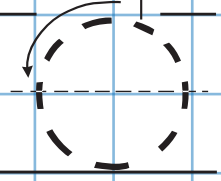
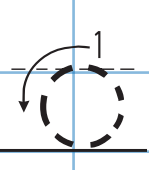
1														
2														
3														
-														
1														
2														
3														
-														
1														
2														
3														
-														
1														
2														
3														
-														
1														
2														
3														
-														
1														
2														
3														

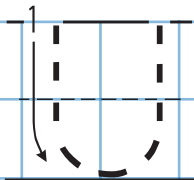
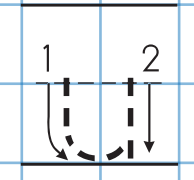
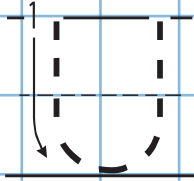
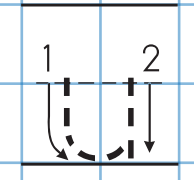
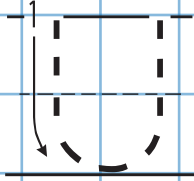
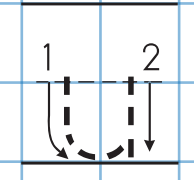
1																				
2																				
3																				
-																				
1																				
2																				
3																				
-																				
1																				
2																				
3																				
-																				
1																				
2																				
3																				
-																				
1																				
2																				
3																				
-																				
1																				
2																				
3																				

1										
2										
3										
-										
1										
2										
3										
-										
1										
2										
3										
-										
1										
2										
3										